



SolidWorks 2001

Getting Started

© 1995-2001, SolidWorks Corporation
300 Baker Avenue
Concord, Massachusetts 01742 USA
All Rights Reserved.

U.S. Patent 5,815,154

SolidWorks Corporation is a Dassault Systemes S.A. (Nasdaq:DASTY) company.

The information and the software discussed in this document are subject to change without notice and should not be considered commitments by SolidWorks Corporation.

No material may be reproduced or transmitted in any form or by any means, electronic or mechanical, for any purpose without the express written permission of SolidWorks Corporation.

As a condition to your use of this software product, you agree to accept the limited warranty, disclaimer and other terms and conditions set forth in the SolidWorks Corporation License and Subscription Service Agreement, which accompanies this software. If, after reading the License Agreement, you do not agree with the limited warranty, the disclaimer or any of the other terms and conditions, promptly return the unused software and all accompanying documentation to SolidWorks Corporation and your money will be refunded.

The software discussed in this document is furnished under a license and may be used or copied only in accordance with the terms of this license. All warranties given by SolidWorks Corporation as to the software and documentation are set forth in the SolidWorks Corporation License and Subscription Service Agreement, and nothing stated in, or implied by, this document or its contents shall be considered or deemed a modification or amendment of such warranties.

SolidWorks® and the SolidWorks logo are the registered trademarks of SolidWorks Corporation.

SolidWorks 2001 is a product name of SolidWorks Corporation.

FeatureManager® is a jointly owned registered trademark of SolidWorks Corporation.

Feature Palette™ and PhotoWorks™ are trademarks of SolidWorks Corporation.

ACIS® is a registered trademark of Spatial Technology Inc.

IGES® Access Library is a registered trademark of IGES Data Analysis, Inc.

FeatureWorks™ is a trademark of Geometric Software Solutions Co. Limited.

GLOBEtrouter® and FLEXlm® are registered trademarks of Globetrotter Software, Inc.

Other brand or product names are trademarks or registered trademarks of their respective holders.

COMMERCIAL COMPUTER SOFTWARE - PROPRIETARY

U.S. Government Restricted Rights. Use, duplication or disclosure by the Government is subject to restrictions as set forth in FAR 52.227-19 (Commercial Computer Software - Restricted Rights), DFARS 252.227-7013(c)(1)(ii)(Rights in Technical Data and Computer Software) and in the license agreement, as applicable.

Contractor/Manufacturer:

SolidWorks Corporation, 300 Baker Avenue, Concord, Massachusetts 01742 USA

Portions of this software are copyrighted by and are the property of Unigraphics Solutions Inc.

Portions of this software © 1990-2001 D-Cubed Limited.

Portions of this software © 1990-2001 LightWork Design Limited.

Portions of this software © 1998-2001 Geometric Software Solutions Co. Limited.

Portions of this software © 1999-2001 Immersive Design, Inc.

Portions of this software © 1999-2001 Viewpoint Corporation

Portions of this software © 1996 Microsoft Corporation. All Rights Reserved.

The IGES Access Library portion of this product is based on IDA IGES Access Library © 1989-1998 IGES Data Analysis, Inc.

All Rights Reserved.

Contents



Mastering the Basics

Installation	1-1
Basic Functionality	2-1
The 40-Minute Running Start	3-1
Assembly Basics	4-1
Drawing Basics	5-1
Design Tables	6-1
More about Basic Functionality	

Working with Features and Parts

Revolve and Sweep Features	7-1
Loft Features	8-1
Pattern Features	9-1
Fillet Features	10-1
More about Features and Parts	

Working with Assemblies

Assembly Mates	11-1
Advanced Design Techniques	12-1
More about Assemblies	

Working with Drawings and Detailing

Advanced Drawings and Detailing	13-1
Bill of Materials	14-1
More about Drawings and Detailing	

Special Topics

Sheet Metal Part	15-1
Mold Design	16-1
3D Sketching	17-1
Importing Files / Using FeatureWorks Software	18-1
Learning to Use PhotoWorks	19-1
SolidWorks Animator	20-1
More about SolidWorks Functionality	



Mastering the Basics

Installation

Basic Functionality

The 40-Minute Running Start

Assembly Basics

Drawing Basics

Design Tables

More about Basic Functionality

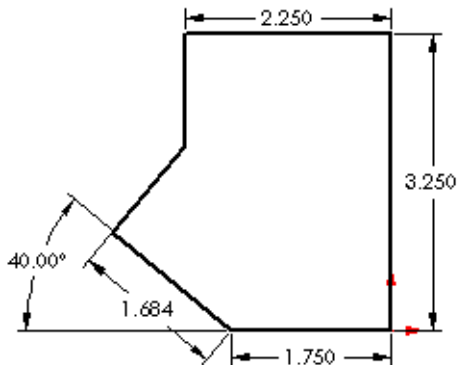

Installation

What is SolidWorks 2001?

SolidWorks[®] 2001 is mechanical design automation software that takes advantage of the familiar Microsoft[®] Windows[®] graphical user interface. This easy-to-learn tool makes it possible for mechanical designers to quickly sketch out ideas, experiment with features and dimensions, and produce models and detailed drawings.

This *Getting Started* book discusses some basic concepts and terminology used throughout the SolidWorks 2001 application. It provides exercises to familiarize you with creating parts, drawings and assemblies, and introduces some of the most commonly used features of the SolidWorks 2001 mechanical design automation system.

This chapter provides an overview of the following topics:

- System requirements for installing and using SolidWorks 2001 software
- Installing the SolidWorks 2001 software
- SolidWorks 2001 service packs
- The SolidWorks Web site

Preparing to Install the SolidWorks 2001 Software

System Requirements

For the most recent information about system requirements, refer to the SolidWorks 2001 Read This First.

Required Information for Installation

Before you install SolidWorks 2001, if you made changes to palette items, drawing templates, or PhotoWorks™ materials in a previous release of the SolidWorks software, you should save backup copies of these files. Put the backup files in a folder where they cannot be lost or overwritten during the installation.

The SolidWorks 2001 Setup Wizard on the CD-ROM guides you through the installation procedure and asks for the following information:

- SolidWorks Serial Number.** For new SolidWorks customers or non-subscription customers, the serial number is located on the box that contains your SolidWorks software. Subscription customers should continue to use the serial number on the CD-ROM case from their first SolidWorks installation.
- SolidWorks Registration Code:**
 - If you are a SolidWorks subscription customer, the registration wizard provides a registration code during the SolidWorks 2001 installation.
 - If you are a new SolidWorks customer, you are asked to use the registration wizard during installation. This generates a registration form that you can email or fax to SolidWorks Corporation. A registration code is provided quickly by return email or fax. You have up to 30 days to use the product without the registration code.
 - If you are a continuing, non-subscription customer, you must have a registration code to update to the SolidWorks 2001 software.
- Serial numbers for add-in software.** If you purchased one or more of the software add-ins available with the SolidWorks application, a serial number for each purchased add-in is located on the box that contains your software add-ins.
- Allow or disallow model changes from drawing.** This option makes it possible for a user to disallow the ability to make changes to part or assembly dimensions from the drawing. (You must reinstall the SolidWorks software to change this option.) The default, and most common configuration, is to allow the part and assembly dimensions to be changed from the drawing.

Installation Procedures

The kinds of installations are, individual, client, server and client, and server only. The installation steps for an individual user or a server are the same, though some of the questions asked during the installation are different.

- ❑ **Individual installation** - This installation is for a computer that will run the SolidWorks 2001 application from its own hard drive and will not share its executable files with any other computer, whether it is on a network or not.
 - To do an individual installation, insert the SolidWorks 2001 CD-ROM in the computer's CD drive and respond to the directions from the install wizard.
 - A serial number and registration code are required.
- ❑ **Server only installation** - This installation is for a computer that will *not* run the SolidWorks 2001 application, but will only act as a server, sharing its SolidWorks installation with one or more SolidWorks client computers. (You must reinstall if you want to change this selection.) With this option, the server does not need to be licensed to run the SolidWorks application, but each client must have a license. This installation should be performed by a network administrator or someone who has experience working with the network server.

NOTE: The server and clients must be of the same platform type. There is no cross-platform installation.

Before starting a SolidWorks server update installation, it is important to ensure that *no* SolidWorks clients are running.

- Insert the SolidWorks 2001 CD-ROM in the computer's CD drive and respond to the directions from the install wizard.
- No serial number or registration code is required for a computer that is used exclusively as a server.
- After installation, make sure that the folder containing the SolidWorks installation is shared and accessible to the client computers on the network.
- ❑ **Server and Client Installation** - This installation is for a computer that will run the SolidWorks 2001 application, and will also act as a server, sharing its SolidWorks installation with one or more SolidWorks client computers.
 - To do a server and client installation, insert the SolidWorks 2001 CD-ROM in the computer's CD drive and respond to the directions from the install wizard.
 - A serial number and registration code are required.
 - After installation, make sure that the folder containing the SolidWorks installation is shared and accessible to the client computers on the network.
- ❑ **Client installation** - The client computer runs the SolidWorks software from a server. No executable files are installed on the client computer, but it is necessary to perform a

SolidWorks client installation to prepare the client computer for sharing the application.

To perform a SolidWorks client installation:

- 1 Make certain that the server installation is complete on the computer from which the clients will run the SolidWorks application. Make make sure that the folder containing the SolidWorks installation is shared and accessible to the client computers on the network.
- 2 Working on the SolidWorks client computer, browse to the folder under the SolidWorks installation directory on the server called **setup\i386**.
- 3 Double-click **setup.exe**.
- 4 The install wizard guides you through the few steps needed to complete the client installation.

NOTE: After installation, to learn about the new functionality in SolidWorks 2001, click  or **Help, SolidWorks 2001 Online User's Guide** on the main toolbar.

SolidWorks 2001 Service Packs

If you are a SolidWorks subscription customer, you can take advantage of SolidWorks service packs that are regularly posted on the SolidWorks Web site. These service packs contain software updates and enhancements to the SolidWorks 2001 software.

To check for a new service pack:

- 1 Click **Help, Service Packs**.
The **Service Packs** dialog box appears.
- 2 Click **Check**. The software checks the SolidWorks Web site to see if you have the latest service pack installed.
- 3 To have the software automatically check the SolidWorks Web site once a week for a new service pack, click the **Check for a new service pack once a week** check box.
- 4 Click **OK** to close the **Service Packs** dialog box.

Visiting the SolidWorks Web Site

If your computer has access to the Internet, you can visit the SolidWorks Web site after you complete the installation. You can learn more about the SolidWorks company and products by clicking in the **Help** menu on the main SolidWorks window.

To access the SolidWorks Web site:

- 1** Click **Help, About SolidWorks 2001**.
- 2** Click **Connect** to visit the SolidWorks Web site.

Some of the available topics are:

- News and Events
- Technical Support
- VARs and Distributors
- The SolidWorks Design Gallery

Basic Functionality

SolidWorks 2001 is supported under the Microsoft Windows graphical user interface. *SolidWorks 2001 Getting Started* assumes that you have used Windows before and know basic Windows skills, such as how to run programs, resize windows, and so on.

Before you begin the examples in *SolidWorks 2001 Getting Started*, you should read Chapter 2, to familiarize yourself with some of the fundamentals, including:

- SolidWorks 2001 design concepts
- SolidWorks 2001 terms
- Getting Help in SolidWorks 2001

Designing with SolidWorks 2001

As you do the examples in this guide, the design methods you use for parts, assemblies, and drawings, represent a unique approach to the design process.

- ❑ **With SolidWorks 2001, you create 3D parts, not just 2D drawings.** You can use these 3D parts to create 2D drawings and 3D assemblies.

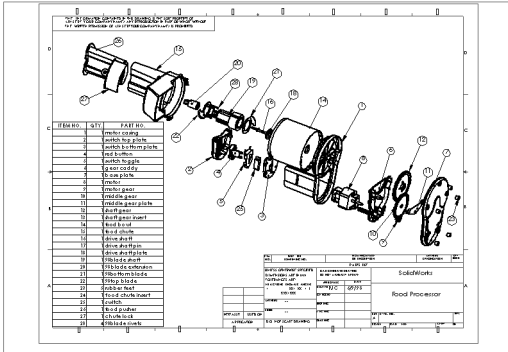

CAD: 2D drawings, made up of individual lines

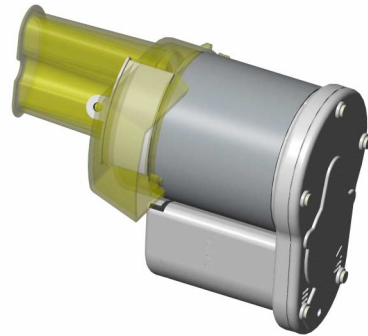

SolidWorks 2001: 3D parts

- ❑ **SolidWorks 2001 is a dimension-driven system.** You can specify dimensions and geometric relationships between elements. Changing dimensions changes the size and shape of the part, while preserving your design intent. For example, in this part, the boss is always half as high as the base.

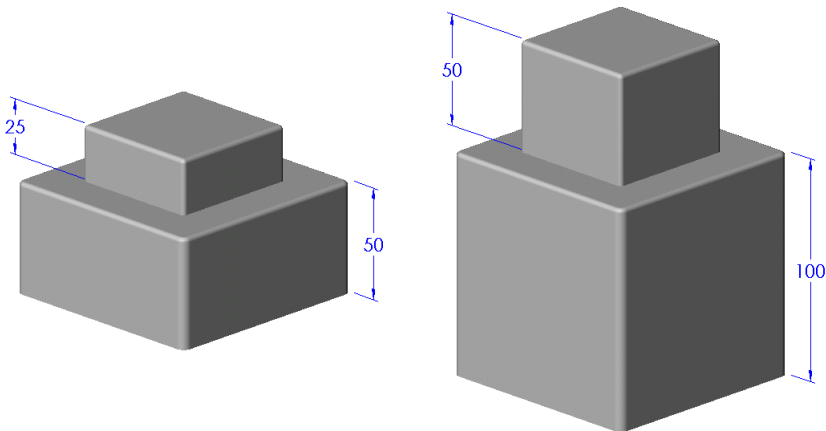

- ❑ **A SolidWorks 3D model consists of parts, assemblies, and drawings.** Parts, assemblies, and drawings display the same model in different documents. Any changes you make to the model in one document are propagated to the other documents containing the model.

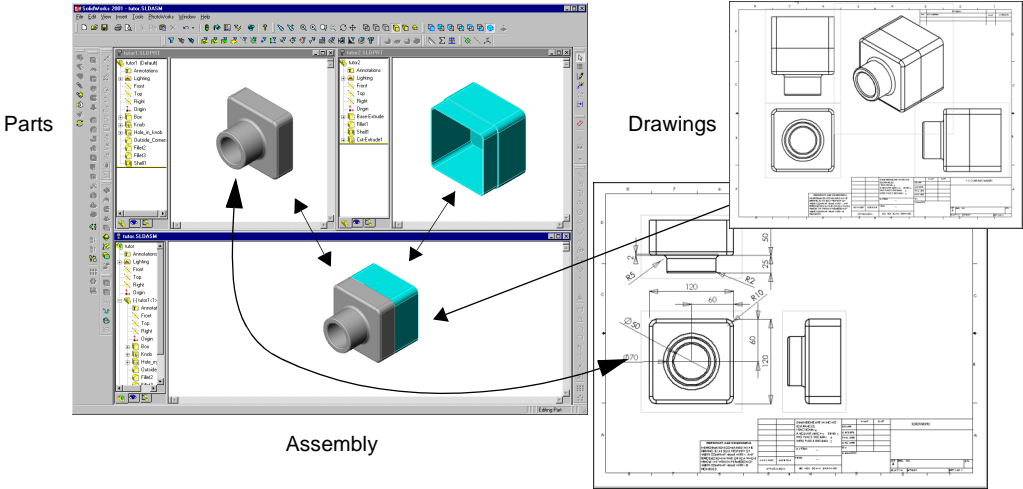

- ❑ **You create sketches and use them to build most features.** A sketch is a 2D profile or cross section. Sketches can be extruded, revolved, lofted, or swept along a path to create features.

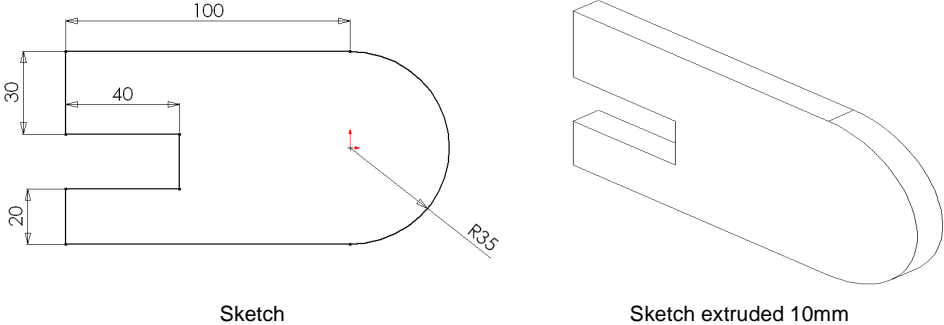

- ❑ **You use features to build parts.** Features are the shapes (bosses, cuts, holes) and operations (fillets, chamfers, shells, and so on) that you combine to build parts.

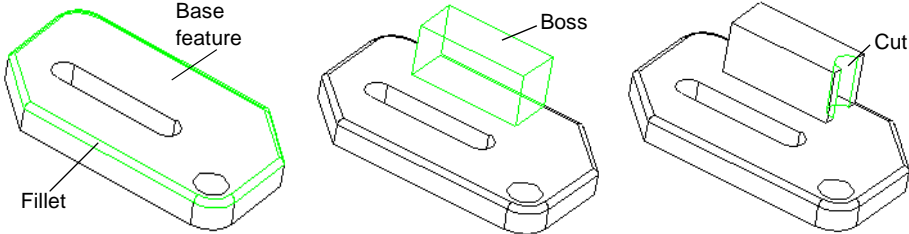

SolidWorks Terms

Document Windows

SolidWorks document windows have two panels:

- ❑ The left panel of the window contains the following:
 - The FeatureManager® design tree lists the structure of the part, assembly, or drawing. For more information about the FeatureManager design tree, see the "More about Basic Functionality" chapter.
 - The PropertyManager provides an alternate way of sketching and otherwise interacting with the SolidWorks 2001 application.
 - The ConfigurationManager is a means to create, select, and view multiple configurations of parts and assemblies in a document.
 - Customized third-party add-in panels.
- ❑ The right panel is the *graphics area*, where you create and manipulate the part, assembly, or drawing.

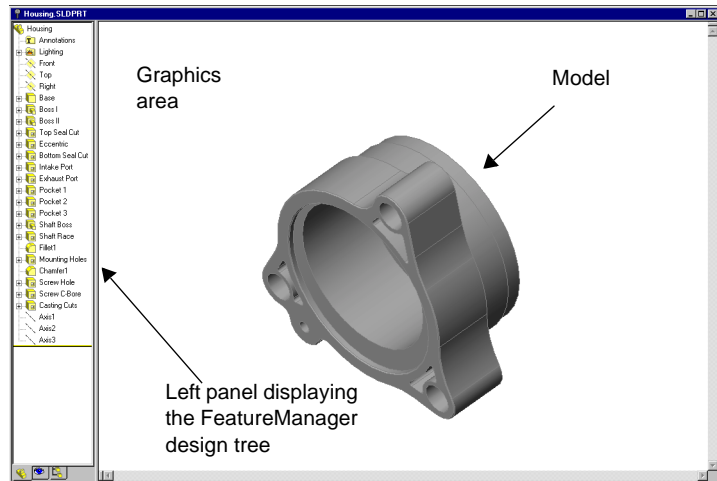

Common Model Terms

You should familiarize yourself with the following terms that appear throughout the SolidWorks documentation. For more information about terms, see the glossary in the *SolidWorks 2001 Online User's Guide*.

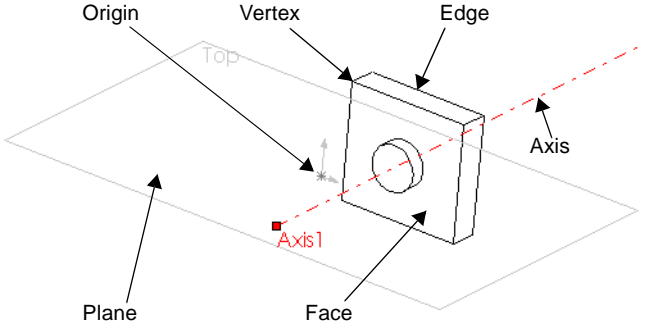

Handles

Handles allow you to dynamically drag and set certain parameters without leaving the graphics area. Active handles are green, inactive handles are gray.

In the *SolidWorks 2001 Getting Started* book however, you set all parameters within the PropertyManager in order to familiarize yourself with this method. After you become accustomed to the options in the PropertyManager, you can experiment with handles on your own.

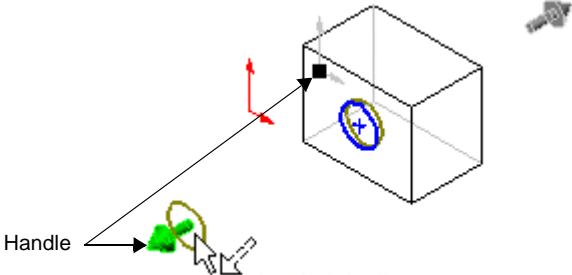

For more information about handles, see the *SolidWorks 2001 Online User's Guide*.

Toolbars

The toolbar buttons are shortcuts for frequently used commands. Some toolbars are always displayed; other toolbars display automatically when you open a document of the related type. For example, when you open an assembly document, the Assembly toolbar appears.



To display or hide individual toolbars:



Click **View, Toolbars**, or right-click the SolidWorks window frame.

A list of all the toolbars is displayed. The toolbars with a check mark beside them are visible; the toolbars without a check mark are hidden. Click the toolbar name to turn its display on or off.

For more information about customizing toolbars, see the "More about Basic Functionality" chapter.

Getting Help

If you have questions while you are using the SolidWorks software, you can find answers in several ways:

- ❑ For **Online help**, click  or **Help, SolidWorks 2001 Help Topics** in the menu bar. The online help also includes a special section, *Overview of New Functionality in SolidWorks 2001*, a summary of the enhancements in SolidWorks 2001. The online help is part of the *SolidWorks 2001 Online User's Guide* that provides detailed information about using the SolidWorks software.
- ❑ For **What's This help**, click  on the Standard toolbar, then click a toolbar icon or a FeatureManager item. What's This help is also available for certain items in the graphics area.
- ❑ For online tutorials that teach you how to create parts, assemblies, and drawings, click **Help, Online Tutorial**. You will also find information on basic SolidWorks software concepts.
- ❑ For ideas about how to best implement your design, click **Help, Design Portfolio**. The Design Portfolio uses sample parts to provide design ideas.
- ❑ For helpful hints, click **Help, Tip of the Day**. To see a tip each time you start SolidWorks 2001, select the **Show tips at startup** check box in the **Tip of the Day** dialog box.
- ❑ For help that describes the active dialog box, and provides access to the full online help system, click the **Help** button in the dialog box or press the **F1** key.
- ❑ For **Tooltips** that identify buttons on a toolbar, point at the button, and a moment later, the tooltip pops up.
- ❑ As you point at toolbar buttons or click menu items, the **Status Bar** at the bottom of the SolidWorks window provides a brief description of the function.

For more information and the latest news about the SolidWorks software and company, visit the SolidWorks web site, <http://www.solidworks.com>, or click **Help, About SolidWorks 2001, Connect**.

The 40-Minute Running Start

This chapter guides you through the creation of your first SolidWorks model. You create this simple part:

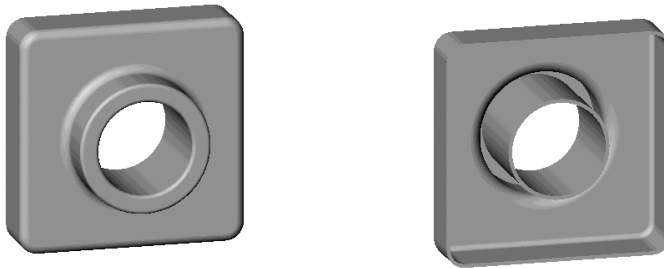

This chapter includes:

- Creating a *base* feature
- Adding a *boss* feature
- Adding a *cut* feature
- Modifying features (adding fillets, changing dimensions)
- Displaying a section view of a part

You should be able to complete this chapter in about 40 minutes.

NOTE: Some of the illustrations in this book have been modified for clarity. What you see on your screen may look different from the illustrations.

Overview of the Next Four Chapters

The *Mastering the Basics* section contains a series of tutorial exercises designed to teach you basic SolidWorks concepts, as follows:

- ❑ Chapter 3. *The 40 Minute Running Start* - Create your first part.
- ❑ Chapter 4. *Assembly Basics* - Add parts and build an assembly.
- ❑ Chapter 5. *Drawing Basics* - Create a drawing of the parts and the assembly.
- ❑ Chapter 6. *Design Tables* - Rename features and dimensions, and create variations of the part from Chapter 3, using a design table.

For consistency, you take the first part you create, then build your knowledge by using the same part throughout this section.



Starting SolidWorks 2001

- 1 Click the **Start** button on the Windows taskbar.
- 2 Click **Programs, SolidWorks 2001,  SolidWorks 2001**.

The SolidWorks main window appears and the Welcome to SolidWorks 2001 screen opens.

NOTE: If a dialog box appears reminding you to register your copy of SolidWorks 2001, click **OK**.

Creating a New Part Document

- 1 To create a new part, click **New Document**  on the Welcome to SolidWorks 2001 screen, click **New**  on the Standard toolbar, or click **File, New**.

The **New SolidWorks Document** dialog box appears.

- 2 Click the **Tutorial** tab and select the **Part** icon.
- 3 Click **OK**.

A new part window appears.

Sketching the Rectangle

The first feature in the part is a box extruded from a sketched rectangular profile. You begin by sketching the rectangle.

- 1 To open a 2D sketch, click **Sketch**  on the Sketch toolbar, or click **Insert, Sketch**. A sketch opens on the **Front** plane.

- 2 Click **Rectangle**  on the Sketch Tools toolbar, or click **Tools, Sketch Entity, Rectangle**.

- 3 Move the pointer to the sketch origin. You know the pointer is on the origin when the pointer changes to . Click the left mouse button and start moving the pointer to create a rectangle.

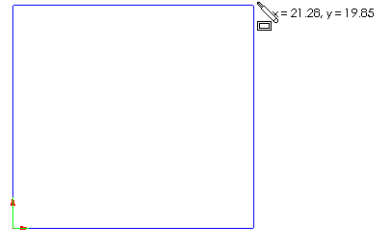

As you move the pointer, notice that it displays the dimensions of the rectangle. Click the mouse button to complete the rectangle.

For more information about inferencing pointers and lines, see the *SolidWorks 2001 Online User's Guide*.

- 4 Click **Select**  on the Sketch toolbar, or click **Tools, Select**.

The two sides of the rectangle that touch the origin are black. Because you began sketching at the origin, the vertex of these two sides is automatically *related* to the origin. (The vertex is not free to move.)

The other two sides (and three vertices) are blue. This indicates that they are free to move.

- 5 Click one of the blue sides, and drag the side or the drag handle at the vertex to resize the rectangle.

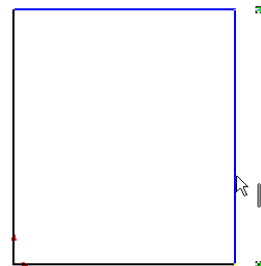

Adding Dimensions

In this section you specify the size of the sketched rectangle by adding dimensions. The SolidWorks software does *not* require that you dimension sketches before you use them to create features. However, for this example, you add dimensions now to fully define the sketch.

As you add dimensions to a sketch, the state of the sketch appears in the status bar. Any SolidWorks sketch is in one of three states. Each state is indicated by a different color:

- ❑ In a *fully defined* sketch, the positions of all the entities are fully described by dimensions or relations, or both. In a fully defined sketch, all the entities are *black*.
- ❑ In an *under defined* sketch, additional dimensions or relations are needed to completely specify the geometry. In this state, you can drag under defined sketch entities to modify the sketch. An under defined sketch entity is *blue*.
- ❑ In an *over defined* sketch, an object has conflicting dimensions or relations, or both. An over defined sketch entity is *red*.

1 Click **Tools, Options**. On the **System Options** tab, click **General**, then click to clear the **Input dimension value** check box. Click **OK**.

2 Click **Dimension**  on the Sketch Relations toolbar, or click **Tools, Dimensions, Parallel**.

The pointer shape changes to .

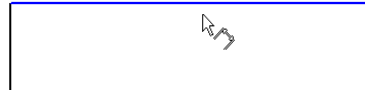

3 Click the top edge of the rectangle, then click where you want to place the dimension.

The vertical line at the right changes from blue to black. By dimensioning the length of the top of the rectangle, you fully defined the position of the rightmost segment. You can still drag the top segment up and down.

Its blue color indicates that it is under defined.

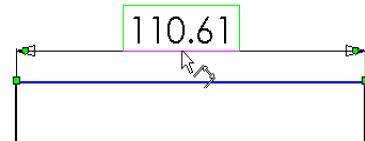

4 Click the right edge of the rectangle, then click to place its dimension.

The top segment and the remaining vertices turn black. The status bar in the lower-right corner of the window indicates that the sketch is fully defined.

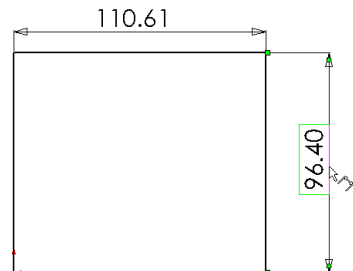

Changing the Dimension Values

To change the dimensions, you use the **Dimensions** tool.



- 1 Double-click one of the dimensions.

The **Modify** dialog box appears. The current dimension is highlighted.



- 2 Type 120mm, then click .

The sketch changes size to reflect the new dimension. The dimension value is now 120mm.

- 3 Click **Zoom to Fit**  on the View toolbar, or press the **f** key, or click **View, Modify, Zoom to Fit**, to display the entire rectangle at full size and to center it in the graphics area.
- 4 Double-click the other dimension and change its value to 120mm.
- 5 Click **Zoom to Fit**  again to center the sketch.

Extruding the Base Feature

The first feature in any part is called the *base feature*. You create this feature by extruding the sketched rectangle.

- 1 Click **Extruded Boss/Base**  on the Features toolbar, or click **Insert, Base, Extrude**.

The **Base-Extrude** PropertyManager appears in the left panel, and the view of the sketch changes to isometric.

- 2 Under **Direction 1**, do the following:
 - Set **End Condition** to **Blind**.
 - Set **Depth**  to 30mm. To increment the value, either use the arrows or enter the value.

When you click the arrows, a preview of the result appears in the graphics area.

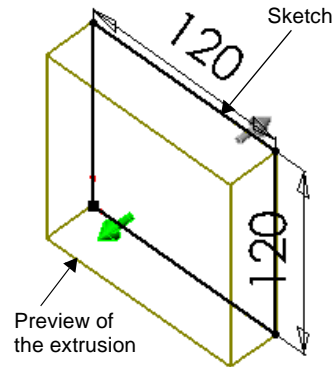

- 3 Click **OK**  to create the extrusion.

The new feature, **Base-Extrude**, appears in the FeatureManager design tree.

- 4 If you need to zoom to view the entire model, press **Z** to zoom out, or press **Shift+Z** to zoom in.

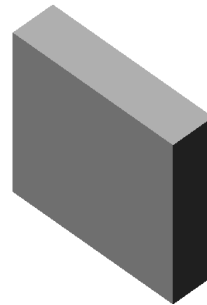

- 5 Click the plus sign  beside **Base-Extrude** in the FeatureManager design tree.

Sketch1, which you used to extrude the feature, is now listed under the feature.

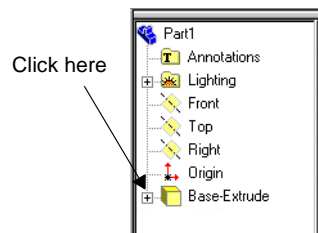

Saving the Part

- 1 Click **Save**  on the Standard toolbar, or click **File, Save**.

The **Save As** dialog box appears.

- 2 Type **Tutor1** and click **Save**.

The extension **.sldprt** is added to the filename, and the file is saved to the current directory. To save the file to a different directory, use the Windows browse button to browse to that directory, then save the file.

NOTE: File names are not case sensitive. That is, files named **TUTOR1.sldprt**, **Tutor1.sldprt**, and **tutor1.sldprt** are all the same part.

Sketching a Boss

To create additional features on the part (such as bosses or cuts), you sketch on the model faces or planes, then extrude the sketches.

NOTE: You sketch on one face or plane at a time, then create a feature based on one or more sketches.

- 1 Click **Hidden Lines Removed**  on the View toolbar, or click **View, Display, Hidden Lines Removed**.

- 2 Click **Select**  on the Sketch toolbar, if it is not already selected.

- 3 Move the pointer over the front face of the part.

The edges of the face become dotted lines to show that the face is available for selection.

The pointer changes to  to show that you are selecting the face.

- 4 Click the front face of the part to select it.

The edges of the face become solid lines and change color to show that the face is selected.

- 5 Click **Sketch**  on the Sketch toolbar, or right-click anywhere in the graphics area and select **Insert Sketch**.

A sketch opens.

- 6 Click **Circle**  on the Sketch Tools toolbar, or click **Tools, Sketch Entity, Circle**.

- 7 Click near the center of the face and move the pointer to sketch a circle. Click again to complete the circle.

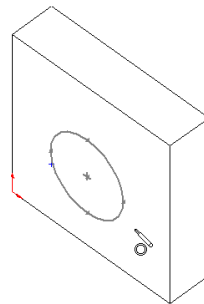
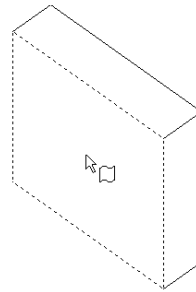



Dimensioning and Extruding the Boss

To establish the location and size of the circle, add the necessary dimensions.

- 1 Click **Dimension**  on the Sketch Relations toolbar, or right-click anywhere in the graphics area and select **Dimension** from the shortcut menu.
- 2 Click the top edge of the face, click the circle, then click a location for the dimension.

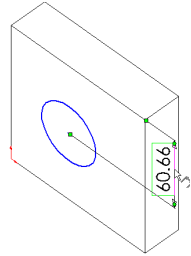
Notice the dimension preview as you click each entity. The preview shows you where the witness lines are attached, and that you have selected the correct entities for the dimension. When you add a locating dimension to a circle, the witness line is attached to the centerpoint by default.



- 3 Click **Select**, double-click the dimension, then enter 60mm as the new value in the **Modify** dialog box.
- 4 Repeat the process to dimension the circle to the side edge of the face. Set this value to 60mm also.
- 5 Still using the **Dimension** tool , click the circle to dimension its diameter. Move the pointer around to see the preview for the dimension.

When the dimension is aligned horizontally or vertically, it appears as a linear dimension; if it is at an angle, it appears as a diameter dimension.

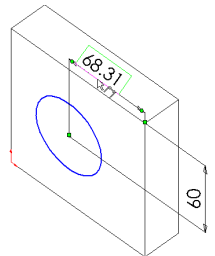



- 6 Click a location for the diameter dimension. Set the diameter to 70mm.

The circle turns black, and the status bar indicates that the sketch is fully defined.

- 7 Click **Extruded Boss/Base**  on the Features toolbar, or click **Insert, Boss, Extrude**.

The **Boss-Extrude** PropertyManager appears.

- 8 Under **Direction 1**, set the **Depth**  of the extrusion to 25mm, leave the other items at the defaults, and click **OK**  to extrude the boss feature.

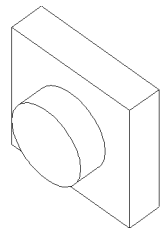
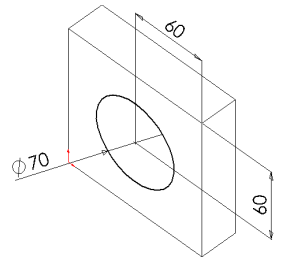

Boss-Extrude1 appears in the FeatureManager design tree.



Creating the Cut

Next, create a cut concentric with the boss.

Sketching and dimensioning the cut

- 1 Click the front face of the circular boss to select it.
- 2 Click **Normal To**  on the Standard Views toolbar.
The part is turned so that the selected model face is now facing you.
- 3 Click **Sketch**  on the Sketch toolbar to open a new sketch.
- 4 Sketch a circle near the center of the boss as shown. Click **Dimension** , and dimension the diameter of the circle to 50mm.

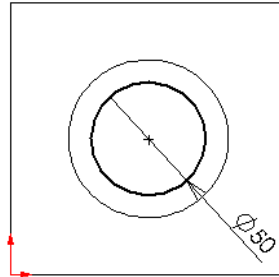

Adding a concentric relation

Now you add a concentric relation between the two circles.

- 1 Click **Add Relation**  on the Sketch Relations toolbar, or click **Tools, Relations, Add**.
The **Add Geometric Relations** dialog box appears.
- 2 Select the sketched circle (the inner circle) and the edge of the boss (the outer circle).
Notice the contents of the **Selected entities** box. Only those relations that are appropriate for the selected entities are available. The most likely relation is automatically selected.
- 3 Make sure that **Concentric** is selected, click **Apply**, and click **Close**.

The inner and outer circles now have a concentric relation.

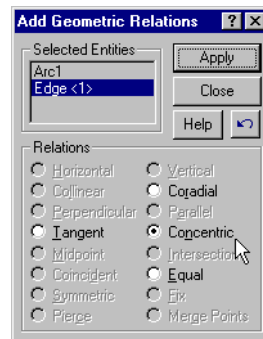



Finishing the cut

Finally, you create the cut.

- 1 Click **Extruded Cut**  on the Features toolbar, or click **Insert, Cut, Extrude**.

The **Cut-Extrude** PropertyManager appears.

- 2 Under **Direction 1**, set the **End Condition** to **Through All**, and click **OK** .
- 3 Click **Isometric**  on the Standard Views toolbar.
- 4 Click **Save**  on the Standard toolbar to save the part.

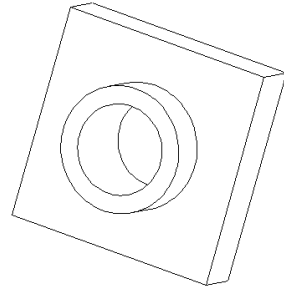





Rounding the Corners of the Part

In this section you round the four corner edges of the part. Because the rounds all have the same radius (10mm), you can create them as a single feature.

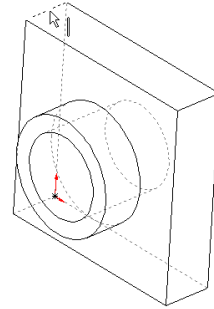
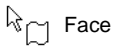
- 1 Click **Hidden In Gray** . This makes it easier to select the hidden edges.
- 2 Click the first corner edge to select it.

Notice how the faces, edges, and vertices highlight as you move the pointer over them, identifying selectable objects. Also, notice the changing pointer shape:





- 3 Click **Rotate View**  on the View toolbar, or click **View, Modify, Rotate**, and drag to rotate the part approximately as shown.
- 4 Click **Select** , then hold down the **Ctrl** key and click the four corner edges.
- 5 Click **Fillet**  on the Features toolbar, or click **Insert, Features, Fillet/Round**.

The **Fillet Feature** PropertyManager appears.

Four callouts appear that show the **Fillet Type** and **Radius** .

Under **Items to Fillet**, the **Edge fillet items** box shows the four selected edges.

- 6 Make sure the **Radius**  is set to 10mm. Leave the remaining items at the default values.
- 7 Click **OK** .

The four selected corners are rounded. The **Fillet1** feature appears in the FeatureManager design tree.

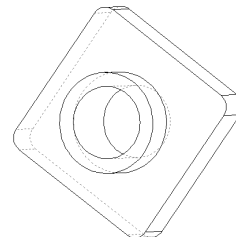
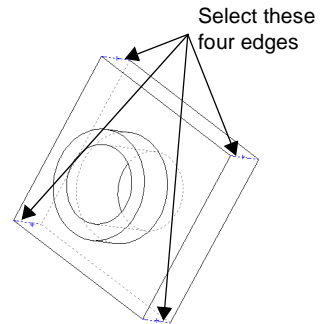

Adding More Fillets

Now add fillets and rounds to other sharp edges of the part. You can select faces and edges either before or after opening the **Fillet Feature** dialog box.

- 1 Click **Hidden Lines Removed** .

- 2 Click **Fillet** .



- 3 Click the front face of the base to select it.

Both the outside and inside edges (around the boss) are highlighted when you select the face.

The **Fillet Feature** PropertyManager appears.

The **Edge fillet items** list shows that one face is selected.

The callout indicates the **Fillet Type** and **Radius** .

- 4 Under **Items to Fillet**, change the **Radius**  to 5mm, and click **OK** .

The inside edge is filleted and the outside edge is rounded in a single step.

- 5 Click **Fillet**  again.

- 6 Click the front face of the circular boss.

- 7 Change the **Radius**  to 2mm, and click **OK** .

Notice that the features listed in the FeatureManager design tree appear in the order in which you created them.

- 8 Click **Rotate View**  and rotate the part to display different views.

- 9 Click **Save**  to save the part.

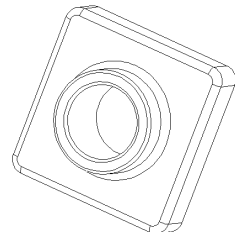
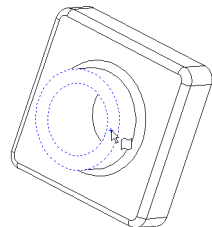
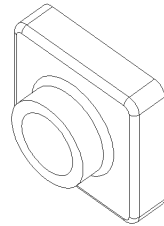
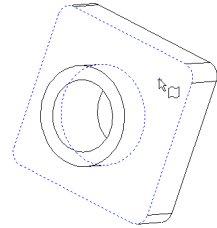

Shelling the Part

Next, you shell the part. Shelling hollows out the part by removing material from the selected face, leaving a thin-walled part.

- 1 Click **Back**  on the Standard Views toolbar.



The back of the part now faces towards you.

- 2 Click **Shell** , or click **Insert, Features, Shell**.

The **Shell1** PropertyManager appears.

- 3 Click the back face to select it.



The selected face appears under **Parameters** in the **Faces to Remove**  list.

- 4 Under **Parameters**, set the **Thickness**  to 2mm and click **OK** .

The shell operation removes the selected face.

- 5 To see the results, click **Rotate View**  and rotate the part.

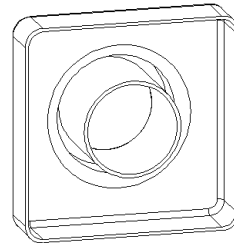
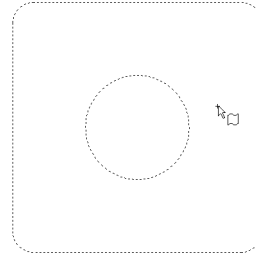

You may need to drag parts to different areas of a window.

- 1 Click **Pan** , or click **View, Modify, Pan**, then click the part, drag it to a new location, and release the mouse button.
- 2 Click **Pan**  again to turn off the **Pan** tool.



Changing a Dimension Using Feature Handles

This section illustrates a way to change the dimension of an extruded feature using feature handles.

- 1 Click **Rotate View**  on the View toolbar and drag to rotate the part approximately as shown. Click **Rotate View**  again to turn it off.
- 2 Double-click **Base-Extrude** in the FeatureManager design tree.



The **Base-Extrude** feature expands to show the sketch it was based on. The feature dimensions appear in the graphics area.

- 3 Click **Move/size features**  on the Features toolbar.

The feature handles for the extruded feature appear. Feature handles allow you to move, rotate, and resize some types of features.

- 4 Drag the **Resize**  handle to increase the depth of the extrusion from 30mm to 50mm.

Watch the pointer for feedback about the dimension you are changing. When you release the pointer, the part rebuilds using the new dimension.

- 5 Click **Move/size features**  to turn off the features handle display.
- 6 Click anywhere outside the part in the graphics area to hide the dimensions.
- 7 Click **Save**  to save the part.

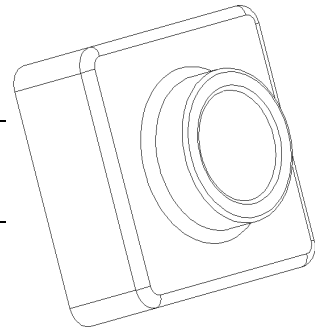
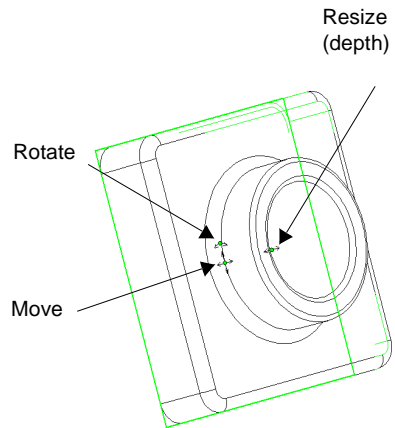

For more information about feature handles, see the *SolidWorks 2001 Online User's Guide*.

NOTE: You can also change a dimension using the **Modify** dialog box method as discussed earlier (see page 3-5).



Displaying a Section View

You can display a 3D section view of the model at any time. You use model faces or planes to specify the section cutting planes. In this example, you use the **Right** plane to cut the model view.

- 1 Click **Isometric** , then click **Shaded**  view mode.
- 2 Click **Right** in the FeatureManager design tree.

The **Right** plane becomes highlighted.

- 3 Click **Section View**  on the View toolbar, or click **View, Display, Section View**.

The **Section View** dialog box appears.

- 4 Select the **Preview** check box.

A section cut arrow appears.



NOTE: When you select the **Preview** option, the view updates each time you change a value in the dialog box.

If a message appears about the model not being properly sectioned, click **OK**.

- 5 Click the up arrow in the **Section Position** box to set the **Section Position** to 60mm.

A section cut plane appears. The view dynamically updates as you increment the value, which is the offset distance from the **Right** plane to the section cut plane.

The section cut arrow indicates the area of the model that will be visible, starting from the section cut plane and going in the direction of the arrow.

TIP: Switch to **Top**  or **Front**  view to better understand how the **Section View** tool works.

- 6 Select the **Flip the Side to View** check box to flip the direction of the section cut arrow.
- 7 Click **OK**.

The section view of the part is displayed. Only the display of the part is cut, not the model itself. The section display is maintained if you change the view mode, orientation, or zoom.

- 8 Click to clear **Section View** .

You return to a complete display of the part.

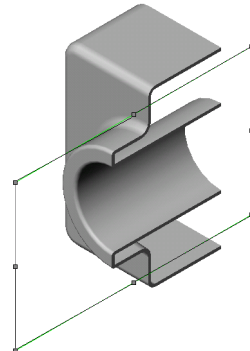
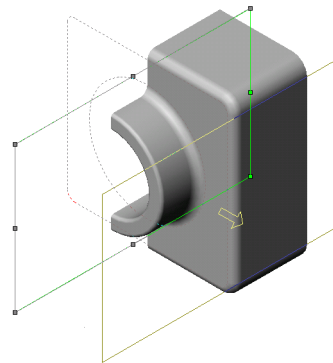

Assembly Basics

In this chapter, you build a simple *assembly*. This chapter discusses the following:

- ❑ *Adding parts* to an assembly
- ❑ *Moving and rotating* components in an assembly
- ❑ Specifying the assembly *mating relations* that make the parts fit together

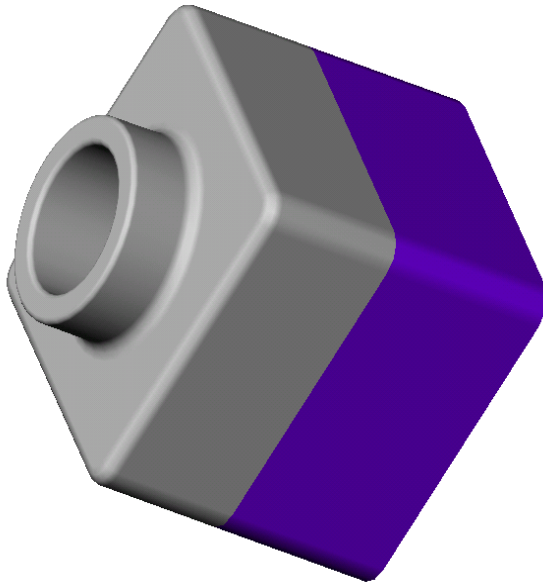

Assembly Overview







An assembly is a combination of two or more parts, also called components, within one SolidWorks document. You position and orient components using mates. Mates form relations between faces and edges of components.

In this chapter, you create a new base part and mate it to the part you created in the *40-Minute Running Start* chapter, to create an assembly.

For more information about assemblies, see the *SolidWorks 2001 Online User's Guide*.

Creating the Base Feature

You can use the same methods you learned in Chapter 3 to create the base for a new part.

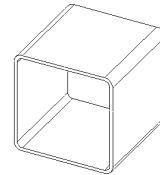
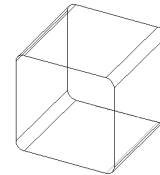
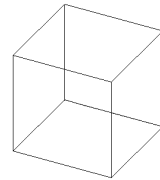

- 1 Open a new part from the **Tutorial** tab.
- 2 Click **Sketch** , and sketch a rectangle beginning at the origin.
- 3 Click **Dimension** , and dimension the rectangle to 120mm x 120mm.
- 4 Click **Extruded Boss/Base** , and extrude the rectangle, with an **End Condition** of **Blind**, to a **Depth**  of 90mm.
- 5 Click **Fillet** , and fillet the four edges shown with a radius of 10mm.
- 6 Click **Shell** . Select the *front* face of the model as the face to remove, and set the **Thickness**  to 4mm.
- 7 Save the part as **Tutor2**. (The **.sldprt** extension is added to the file name.)



Creating a Lip on the Part

In this section, you use the **Convert Entities** and **Offset Entities** tools to create sketch geometry. Then a cut creates a lip to mate with the part from the previous chapter.

TIP: Use the **Selection Filter** to make selecting the faces in this section easier. See "Selection Filter" in "More about Basic Functionality" for more information.

- 1 Click **Zoom to Area** , or click **View, Modify, Zoom to Area**, and zoom in on a corner of the part, as shown. Click **Zoom to Area**  again to turn off the tool.

- 2 Select the thin wall on the front face of the part, and click **Sketch**  to open a sketch.

The edges of the part face are highlighted.

- 3 Click **Convert Entities**  on the Sketch Tools toolbar, or click **Tools, Sketch Tools, Convert Entities**.

The outer edges of the selected face are projected (copied) onto the sketch plane as lines and arcs.

- 4 Click the front face again.
- 5 Click **Offset Entities**  on the Sketch Tools toolbar, or click **Tools, Sketch Tools, Offset Entities**.

- 6 Set the **Offset Distance**  to 2mm.

The preview shows the offset extending outward.

- 7 Select the **Reverse** check box to change the offset direction.
- 8 Click **OK** .

A set of lines is added in the sketch, offset from the outside edge of the selected face by 2mm. This relation is maintained if the original edges change.

- 9 Click **Extruded Cut** , or click **Insert, Cut, Extrude**.

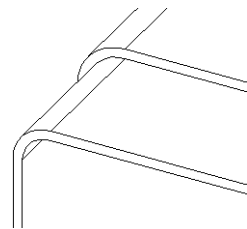
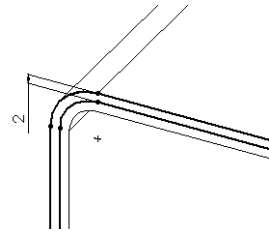
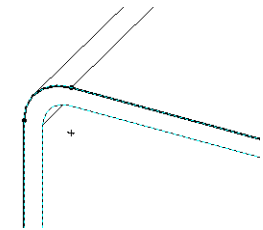
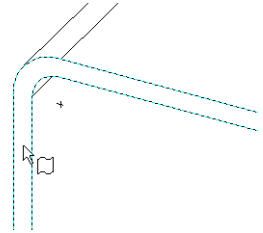

- 10 Under **Direction 1**, set the **Depth**  to 30mm, and click **OK** .

The material between the two lines is cut, creating the lip.



Changing the Color of a Part

You can change the color and appearance of a part or its features.

- 1 Click the **Tutor2** icon at the top of the FeatureManager design tree.
- 2 Click **Shaded** .
- 3 Click **Edit Color**  on the Standard toolbar.
The **Edit Color** dialog box appears.
- 4 Click the desired color on the palette, then click **OK**.
- 5 Save the part.

Creating the Assembly

Now create an assembly using the two parts.

- 1 If **Tutor1.sldprt** is not open, click **Open**  on the Standard toolbar and open it.
- 2 Open a new assembly from the **Tutorial** tab.
- 3 Click **Window, Tile Horizontally** to display all three windows. Close any extra windows.
- 4 Drag the **Tutor1** icon from the top of the FeatureManager design tree for **Tutor1.sldprt**, and drop it *in the FeatureManager design tree* of the assembly window (**Assem1**).

Notice that as you move the pointer into the FeatureManager design tree, the pointer changes to .



Adding a part to an assembly this way results in the part automatically inferencing the assembly origin. When a part inferences the assembly origin:

- the part's origin is coincident with the assembly origin.
- the planes of the part and the assembly are aligned.

- 5 Drag the **Tutor2** icon from **Tutor2.sldprt**, and drop it *in the graphics area* of the assembly window, beside the **Tutor1** part.

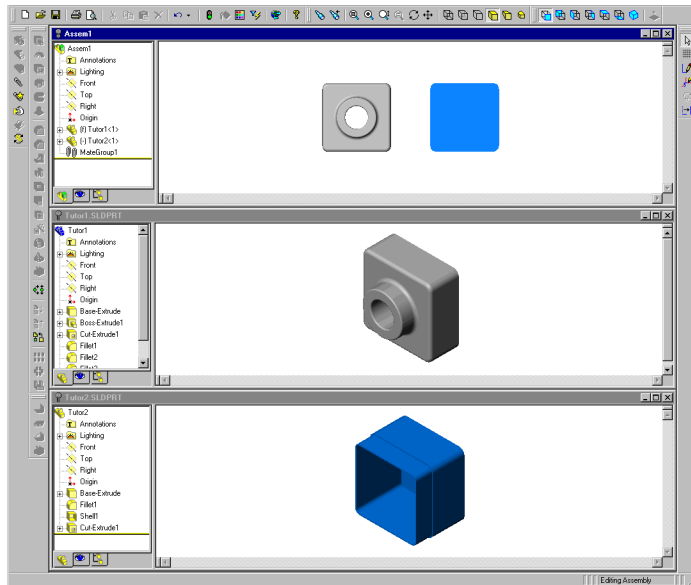

Notice that as you move the pointer into the graphics area, the pointer changes to .





- 6 Save the assembly as **Tutor**. (The **.sldasm** extension is added to the file name.) If you see a message about saving referenced documents, click **Yes**.
- 7 Drag a corner of the assembly window to enlarge it, or click **Maximize**  in the upper-right corner to make the window full size. You no longer need to have the **Tutor1.sldprt** and **Tutor2.sldprt** windows in view.
- 8 Click **Zoom to Fit** .

Mating the Components

In this section, you define *assembly mating relations* between the components, making them align and fit together.

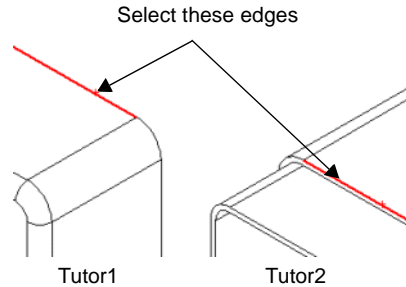
- 1 Click **Isometric**  on the Standard Views toolbar.
- 2 Click **Mate**  on the Assembly toolbar, or click **Insert, Mate**.
- 3 Click the top edge of **Tutor1**, then click the outside edge of the lip on the top of **Tutor2**.
The edges appear in the **Selections** list.





- 4 Under **Selections**, do the following:
 - Click **Coincident**  as the mate type.
 - Click **Closest** as the **Mate Alignment**.

- 5 Click **Preview** to preview the mate.
The selected edges of the two components are made coincident.

- 6 Click **OK** .

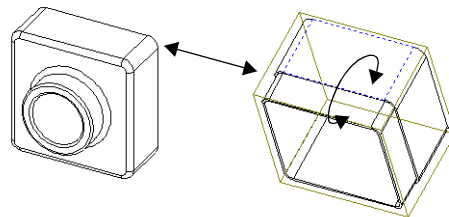

The position of the **Tutor2** component in the assembly is not fully defined, as shown by the (-) prefix in the FeatureManager design tree. **Tutor2** still has some degrees of freedom to move in directions that are not yet constrained by mating relations.

- 1 Click **Move Component** .
- 2 Click the **Tutor2** component and hold down the left mouse button.
Notice the pointer shape .
- 3 Drag the component from side to side to observe the available degrees of freedom, then release the left mouse button.



- 4 Click **Move Component**  again to exit move mode.

Adding More Mates

- 1 Select the rightmost face of one component, then hold down **Ctrl**, and select the corresponding face on the other component.
- 2 Click **Mate** .
- 3 Select **Coincident**  and **Closest**.
- 4 Click **Preview** to preview the mate.
- 5 Click **OK** .
- 6 Repeat Steps 1 through 5, selecting the top faces of both components, to add another **Coincident** mate.
- 7 Save the assembly.

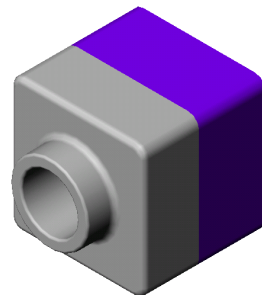
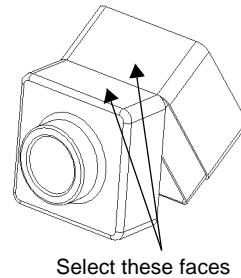
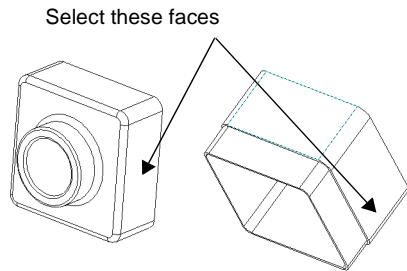

Drawing Basics

In this chapter, you create a multi-sheet drawing of the parts and assembly from the previous chapters. This chapter includes:

- Opening a *drawing template* and editing a *sheet format*
- Inserting *standard views* of a part model
- Adding *model and reference annotations*
- Adding another *drawing sheet*
- Inserting a *named view*
- Printing* the drawing

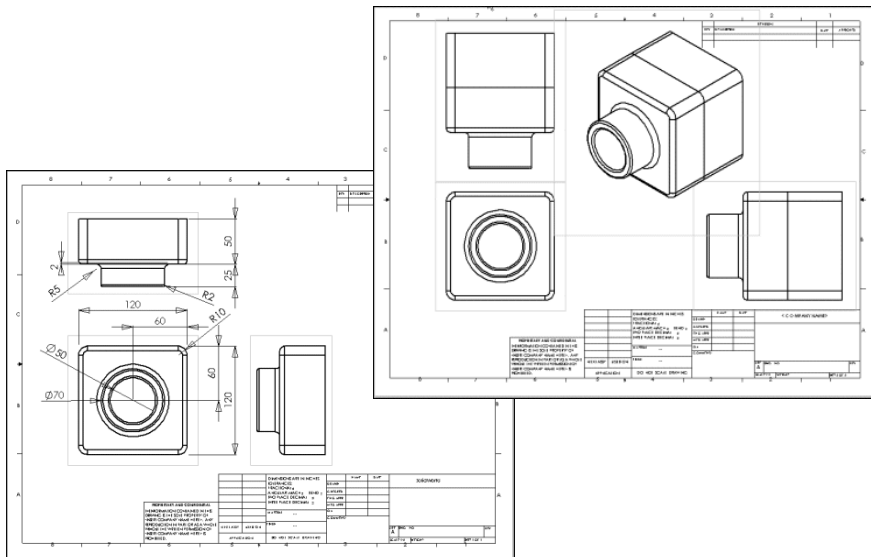



Opening a Drawing Template

First you open a drawing template.

- 1 Click **New**  on the Standard toolbar.
The **New SolidWorks Document** dialog box appears.
- 2 Select the **Tutorial** tab, click the **Drawing** icon, then click **OK**.
A new drawing window appears, with note text.

Preparing the Drawing Template Format

Next you prepare the drawing sheet format by changing some text properties.

- 1 Right-click anywhere in the drawing, and select **Edit Sheet Format**.
- 2 Click **Zoom to Area** , zoom in on the title block at the lower right, then click  again to turn off **Zoom to Area**.
- 3 Right-click the note with the text **<COMPANY NAME>** and select **Properties**.
The **Properties** dialog box appears.
- 4 Change the **Note text** to the name of your company.
- 5 Click **Font**.
The **Choose Font** dialog box appears.
- 6 Choose a different font, style, or size, then click **OK**.
- 7 Click **OK** to close the **Properties** dialog box.
- 8 Right-click in the graphics area, and select **Edit Sheet** to exit the edit sheet format mode.

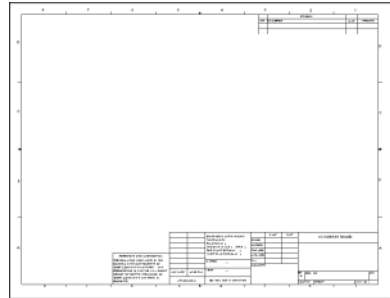

Next you save the updated drawing sheet format.

- 1 To replace this format as the standard **A-Landscape** format, click **File, Save Sheet Format**.
The **Save Sheet Format** dialog box appears.
- 2 Click **OK**.

- 3 Click **Yes** to confirm that you want to overwrite the existing sheet format. When you choose this format for your own drawings, you will not need to perform these edits again.

NOTE: To save the sheet format with a new name and to *not* overwrite the standard sheet format, click **File, Save Sheet Format, Custom Sheet Format**. Click **Browse** and navigate to the directory where you want to save the format. Type a name and click **Save**. Click **OK** to close the dialog box.

Setting the Detailing Options

Next, set the default dimension font, and the style of dimensions, arrows, and other detailing options. For this chapter, use the settings described below. Later, you can set the **Detailing** options to match your company's standards.

- 1 Click **Tools, Options**.
- 2 On the **Document Properties** tab, click **Detailing**. In the **Dimensioning Standard** section, in the **Trailing Zeroes** box, select **Remove**.
- 3 Under **Detailing**, click **Dimensions**. Click **Font**.
The **Choose Font** dialog box appears.
- 4 In the **Height** box, click **Points**, and type or select 16.
- 5 Click **OK**.
- 6 Under **Detailing**, click **Arrows**, and review the default styles and sizes.
Notice the different attachment styles for edges, faces, and unattached items.
- 7 Click **OK** to close the **Options** dialog box.

For more information about these options, see the *SolidWorks 2001 Online User's Guide*.

Creating a Drawing of a Part

1 Open **Tutor1.sldprt** if it is not open. Then return to the drawing window.

2 Click **Standard 3 View**  on the Drawing toolbar, or click **Insert, Drawing View, Standard 3 View**.

Notice the pointer .

The **Standard View** Property Manager displays a message explaining four methods to select a model.

3 From the **Window** menu, select **Tutor1.sldprt**.

The **Tutor1.sldprt** window appears.

4 Click in the graphics area of the part window. The drawing window reappears with the three views of the selected part.

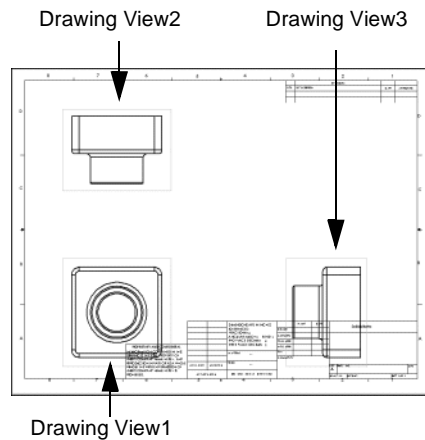

TIP: Another method of creating a Standard 3 View is to tile the windows, and drag the part from the part document to the graphics area of the drawing.

Moving Drawing Views

To move a view, click inside its boundary. When the pointer is at the border, it changes to , and you can drag the view in its allowed directions.

1 Click **Drawing View2**, then drag it up and down.

2 Click **Drawing View3**, then drag it left and right.

Drawing View2 and **Drawing View3** are aligned to **Drawing View1**, and only move in one direction to preserve the alignment.

3 Click **Drawing View1** and drag it in any direction to move all the views at the same time.

4 Move the views on the drawing sheet to the approximate positions shown.

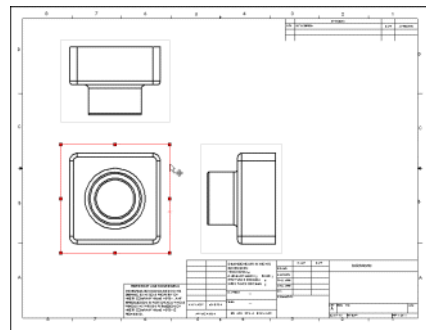

Adding Dimensions to a Drawing

Drawings contain 2D views of models. You can choose to display dimensions specified in the model in all of the drawing views.



- 1 With nothing selected, click **Insert, Model Items**.

The **Insert Model Items** dialog box appears. You can select which types of dimensions, annotations, and reference geometry to import from the model.

- 2 Make sure that **Dimensions** and **Import items into all views** are selected, and click **OK**.

Dimensions are imported into the view where the feature they describe is most visible. Only one copy of each dimension is imported because the **Eliminate duplicate model dimensions** check box is selected.

- 3 Drag the dimensions to position them.

TIP: Select a drawing view, then click **Zoom To Selection**  to zoom the view to fill the screen. Click **Zoom to Fit**  to see the entire drawing sheet.

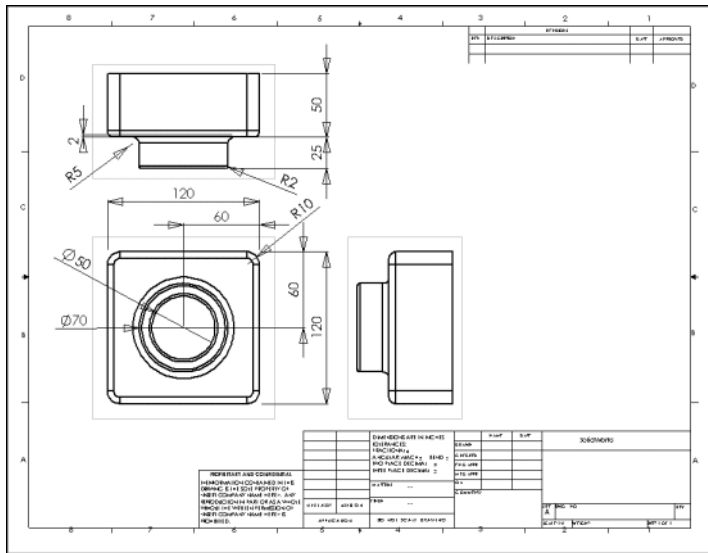

- 4 Click **Save** , and save the drawing document as **Tutor1**. The default extension is **.slddrw**.

Modifying Dimensions

When you change a model dimension in the drawing view, the model is automatically updated to reflect the change, and vice versa.

- 1 In **Drawing View2**, double-click the dimension for the depth of the boss extrusion.

The **Modify** dialog box appears.

- 2 Change the value from 25mm to 40mm, and press **Enter**.

- 3 Click **Rebuild**  on the Standard toolbar, or click **Edit, Rebuild**.

The part rebuilds using the modified dimension. Both the drawing and the part model are updated.

- 4 Click **Window**, and select the **Tutor1.sldprt** window.
- 5 Double-click **Boss-Extrude1** in the FeatureManager design tree to display the dimensions of the feature.

Notice that the depth dimension is 40mm.

- 6 Return to the drawing window, and save the drawing.

The system notifies you that the model referenced in the drawing has been modified, and asks if you want to save it.

- 7 Click **Yes** to save both the drawing and the updated model.

Now rebuild the assembly that contains the modified part.

- 1 Open **Tutor.sldasm** if it is not still open.

If a message appears asking you if you want to rebuild the assembly, click **Yes**.

The assembly rebuilds with the new dimensions.

- 2 Return to the drawing window.

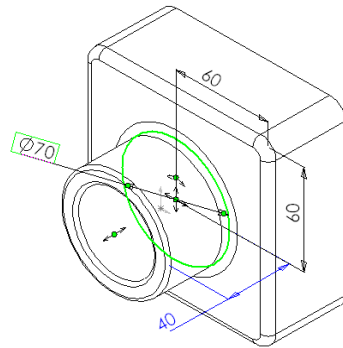
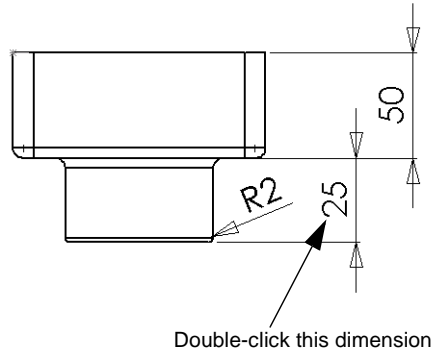

Adding Another Drawing Sheet

Now you create an additional drawing sheet for the assembly. You then use the **Insert From File** command to insert an assembly document into the drawing.

- 1 Click **Insert, Sheet**.

The **Sheet Setup** dialog box appears.

- 2 Under both **Paper size** and **Sheet Format**, select **B-Landscape**, and click **OK**.

Sheet2 opens and is added to the drawing document.

- 3 Click **Standard 3 View** , right-click in the graphics area, and select **Insert From File**.

The **Insert Component** dialog box appears.

- 4 Set **Files of type** to **Assembly Files (*.asm, *.sldasm)**, navigate to **Tutor.sldasm**, and click **Open**.

The Standard 3 Views of the assembly appear on the drawing sheet.

- 5 Reposition the views on the sheet if needed.

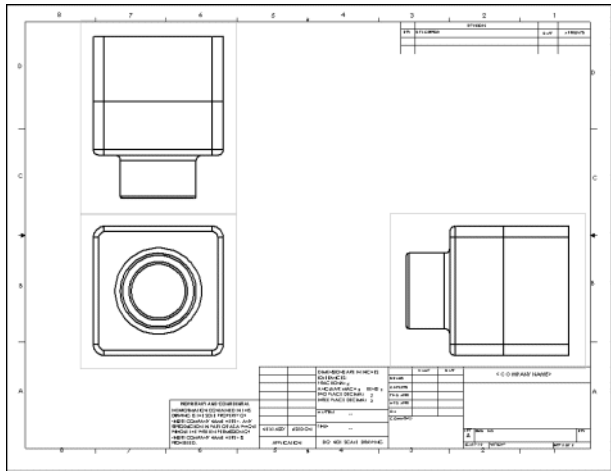

Inserting a Named View

You can add named views to drawings, showing the model in different orientations. You can use:

- A standard view (**Front, Top, Isometric**, and so on)
- A named view orientation that you defined in the part or assembly
- The current view in the part or assembly document

Zoom levels are ignored, however, and the entire model is always displayed in the selected orientation.

In this section you add an isometric view of the assembly.

- 1 Click **Named View** , or click **Insert, Drawing View, Named View**.

The **Named View** PropertyManager appears.

The pointer  indicates that you may select a model to display in the drawing.

- 2 Right-click in the graphics area, and select **Insert From File**.

The **Insert Component** dialog box appears.

- 3 Navigate to **Tutor.sldasm**, and click **Open**.

The **Named View** PropertyManager appears. Note its similarity to the **Orientation** dialog box.

The pointer  indicates that you may select a location in the drawing to place the named view.

- 4 Click where you want to place the view.
- 5 Double-click ***Isometric** from the list to switch to an isometric view.

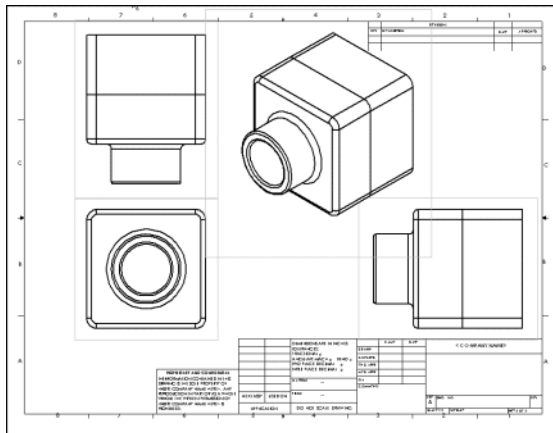

Printing the Drawing

- 1 Click **File, Print**.

The **Print** dialog box appears.

- 2 Set **Print range** to **All**, and make sure that the **Scale to fit** check box is selected.
- 3 Click **OK** to close the **Print** dialog box and print the drawing.

- 4 Click **Save** .

The system notifies you that the model referenced in the drawing has been modified, and asks if you want to save it.

- 5 Click **Yes**, then close the drawing.

Design Tables

In this chapter you use a design table to create several variations of the part you designed in Chapter 3, “The 40-Minute Running Start.” To use a design table, you must have Microsoft Excel on your computer. For more information, see Chapter 1, “Installation.”

This exercise demonstrates the following:

- Renaming* features and dimensions
- Displaying* feature dimensions
- Linking values* of model dimensions
- Verifying* geometric relations
- Creating a *design table*
- Displaying part *configurations*

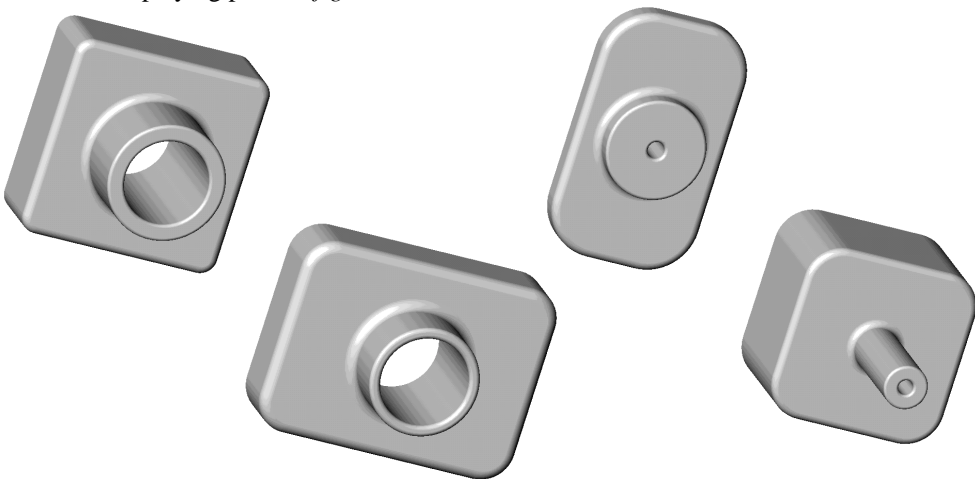

Renaming Features

It is a good practice to give meaningful names to the features in your parts, especially when you plan to use a design table. This can save confusion in complex parts, and it is helpful to other people who use the parts later.

- 1 Open **Tutor1.sldprt** that you created in Chapter 3.
- 2 Change the generic name **Base-Extrude** to something more meaningful.

NOTE: Feature names cannot contain the @ character.

- a) Click-pause-click on **Base-Extrude** in the FeatureManager design tree (do not double-click).
 - b) Type the new name, **Box**, and press **Enter**.
- 3 Rename these other features:
 - **Boss-Extrude1** => **Knob**
 - **Cut-Extrude1** => **Hole_in_knob**
 - **Fillet1** => **Outside_corners**
 - 4 Save the part as **Tutor3.sldprt**.

TIP: To give descriptive names to features as you create them, click **Tools, Options**. On the **System Options** tab, click **FeatureManager**, then select the **Name feature on creation** check box. Each time you create a new feature, the name of the new feature in the FeatureManager design tree is automatically highlighted, and ready for you to type a new name.

Displaying Dimensions

You can display or hide all the dimensions for all the features of the part. Then you can turn the display of dimensions on and off, either individually, or on a feature-by-feature basis.

- 1 Right-click the **Annotations**  folder in the FeatureManager design tree, and select **Show Feature Dimensions**.

All the dimensions for the part appear. Notice that the dimensions that are part of a feature's definition (such as the depth of an extruded feature) are blue.

- 2 Right-click the **Fillet2**, **Fillet3**, and **Shell1** features in the FeatureManager design tree or in the graphics area, and select **Hide All Dimensions**.

All the dimensions for these features are hidden.

- 3 Right-click one of the dimensions set to **60**, and select **Hide**.

This individual dimension is hidden. It belongs to the **Knob** feature.

NOTE: To restore hidden dimensions, right-click the feature in the FeatureManager design tree whose dimensions are either partially or completely hidden, and select **Show All Dimensions**.

- 4 Click **Tools, Options**. On the **System Options** tab, click **General**, then select the **Show dimension names** check box, and click **OK**.

The dimension names appear below the values in the model.

Dimension names appear with default names. You can rename dimensions, similar to renaming features. You will rename dimensions later in this chapter.

Linking Values

Linking values is a way to control values that are not part of a sketch, such as the depth of two extruded features.

You link dimensions by assigning them the same variable name. Then you can modify the value of *any* of the linked dimensions, and all of the other dimensions with the same variable name change accordingly.

You can unlink any of the dimensions without affecting the ones that you want to remain linked.

For this example, you set the extrusion depth of the **Box** and the **Knob** to be equal:

- 1 Right-click the dimension for the extruded depth (50mm) of the **Box**, and select **Link Values**.

The **Shared Values** dialog box appears.

- 2 Type **depth** in the **Name** box, and click **OK**.
- 3 Right-click the dimension for the depth (40mm) of the **Knob**, and select **Link Values**.
- 4 Click the arrow beside the **Name** box, select **depth** from the list, and click **OK**. (Each time you define a new **Name** variable, it is added to this list.)

Notice that the two dimensions now have the same name, **depth**. They use the dimension value of the first dimension you clicked (50mm).

- 5 Click **Rebuild**  to rebuild the part.

The **Knob** changes to 50mm depth.

Renaming Dimensions

You can change individual dimension names. Renaming dimensions is a good practice, and it is especially useful when you plan to use a design table. You use the dimension names to identify the elements you plan to change, and as headings in the design table worksheet.

1 Change the name of the knob diameter dimension:

- a) Right-click the **Knob** diameter dimension (70mm), and select **Properties**.

The **Dimension Properties** dialog box appears.

- b) Select the text in the **Name** box and type in a new name, **knob_dia**.

Notice that the **Full name** box is updated as you type.

- c) Click **OK**.

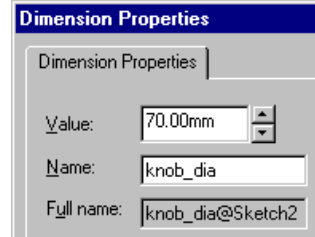

2 Rename the height of the box (120mm) to **box_height**.

3 Rename the width of the box (120mm) to **box_width**.

4 Rename the diameter of the hole in the knob (50mm) to **hole_dia**.

5 Rename the radius of the outside corners (10mm) to **fillet_radius**.

6 Save the part.

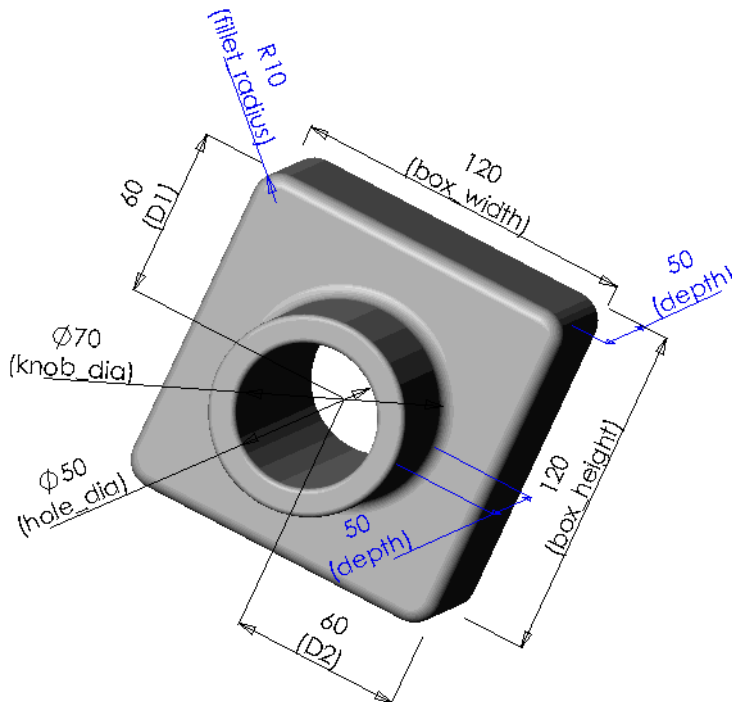

Verifying Relations

Before you proceed, you should define some geometric relations that ensure that the knob is positioned correctly with respect to the center of the box, regardless of the size. Relations add to the integrity of the design, and they are often the most effective way to convey the design intent accurately.

- 1 In the FeatureManager design tree or the model, right-click the **Knob** feature, and select **Edit Sketch**.

- 2 Click **Hidden Lines Removed** , and click **Normal To** .

The front of the model now faces towards you.

- 3 Delete the dimensions (60mm) between the circle and the sides of the box.
- 4 Click the centerpoint of the circle, and drag the circle to one side.

- 5 Click **Centerline** , or click **Tools, Sketch Entity, Centerline**, and sketch a diagonal centerline as shown. Press **Esc** to exit the **Centerline** tool.

- 6 Add a relation between the midpoint of the centerline and the centerpoint of the circle:

- a) Click **Add Relation** , or click **Tools, Relations, Add**.

The **Add Geometric Relations** dialog box appears.

- b) Click the centerpoint of the circle and the centerline.
- c) Click **Midpoint**, and click **Apply**.

The circle turns black, indicating the sketch is now fully defined.

- d) Click **Close**.

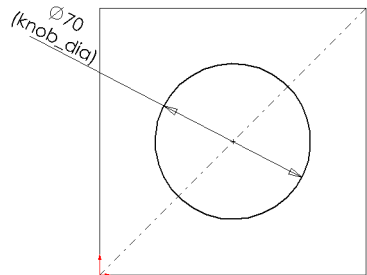

Now verify the relations in this sketch:

- 1 Click **Display/Delete Relations** , or click **Tools, Relations, Display/Delete Relations**.

The **Display/Delete Relations** dialog box appears.

- 2 Click **Next** or **Previous**  to review all the relations in the sketch.

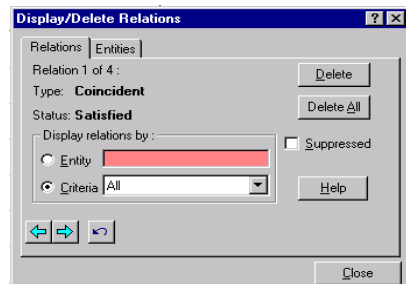

Mastering the Basics

As you display each relation, the entities are highlighted in the graphics area.



NOTE: If a sketch entity is selected when you click **Display/Delete Relations**, only the relations on the selected entity are listed. Click a different entity to display its relations. You can change the **Criteria** in the **Display relations by** box to specify the types of relations (**All**, **Dangling**, and so on) that are displayed.

- 3 Click the **Entities** tab for more information about the highlighted entities.
- 4 Click **Close** to close the **Display/Delete Relations** dialog box.
- 5 Click **Sketch**  to close the sketch.
- 6 Save the part.

Inserting a New Design Table

If you have Microsoft Excel on your computer, you can use it to embed a new design table directly in the part document. A design table allows you to build several different *configurations* of a part by applying the values in the table to the dimensions of the part.

First you should prepare to insert the design table.

- 1 Click **Tools, Options**. On the **System Options** tab, click **General**.
- 2 Make sure that the **Edit design tables in a separate window** check box is not selected, and click **OK**.
- 3 Click **Isometric** .
- 4 Press **Z** to zoom out or **Shift+Z** to zoom in and resize the part so you can see all of the part's dimensions in the graphics area. Use the **Pan** tool , if necessary, to move the part to the lower right corner of the window.
- 5 Click **Select**  to deselect any active View tool.

Now you are ready to insert a new design table.

NOTE: If you accidentally click outside the worksheet before entering all the values, click **Edit, Design Table** to redisplay the design table.

- 1 Click **Insert, New Design Table**.

An Excel worksheet appears in the part document window. Excel toolbars replace the SolidWorks toolbars. By default, the first row (cell A3) is named **First Instance**, and column header cell B2 is active.

- 2 Double-click the **box_width** dimension *value* (120) in the graphics area.

Notice that the pointer changes to  when it is over a dimension value.

The dimension name and value are inserted in cell B3. The adjacent column header cell, C2, is activated automatically.

TIP: To uncover dimensions hidden by the design table, point at the Excel worksheet's outer dashed border and drag the worksheet to another location in the graphics area. To resize the worksheet, drag the handles at the corners or sides.

Mastering the Basics

- 3 Double-click each dimension value in the graphics area to insert the rest of the dimension names and values, as shown in the illustrations in steps 4 and 5. Do not include depth@Box (50mm).

NOTE: If you see **\$STATE@** followed by a feature name in a column header cell, you selected a face instead of a dimension value in the graphics area. To replace a feature name with a dimension name, click the cell in the worksheet, then double-click the correct dimension value in the graphics area.

- 4 Name the rows (cells A4:A6) **blk2** through **blk4**. These are the names of the configurations that the design table produces.



	A	B	C	D	E	F	G
2		box_width@Sketch1	box_height@Sketch1	knob_dia@Sketch2	hole_dia@Sketch3	fillet_radius@Outside_corners	depth@Knob
3	First Instance	120	120	70	50	10	50
4	blk2						
5	blk3						
6	blk4						

- 5 Type the following dimension values into the worksheet:

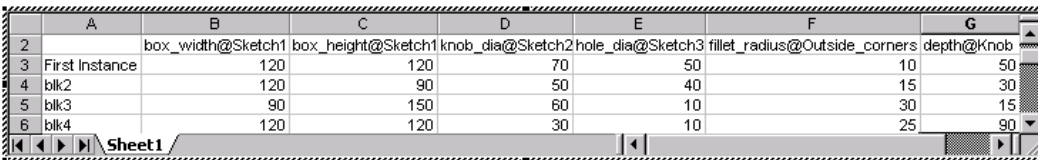

	A	B	C	D	E	F	G
2		box_width@Sketch1	box_height@Sketch1	knob_dia@Sketch2	hole_dia@Sketch3	fillet_radius@Outside_corners	depth@Knob
3	First Instance	120	120	70	50	10	50
4	blk2	120	90	50	40	15	30
5	blk3	90	150	60	10	30	15
6	blk4	120	120	30	10	25	90

- 6 Click anywhere outside the worksheet in the graphics area.

The worksheet closes. An informational dialog box appears, listing the new configurations that the design table created.

- 7 Click **OK** to close the dialog box.



The design table is *embedded* and saved in the part document.

- 8 Save the part.

If a message appears asking if you want to rebuild the part, click **Yes**.

Viewing the Configurations

Now look at each of the configurations generated by the table.

- 1 Click **Shaded** .
- 2 Click the ConfigurationManager tab  at the bottom of the FeatureManager design tree.

The list of configurations appears.

- 3 Double-click the name of a configuration.

As you display each of the configurations, the part rebuilds using the dimensions for the selected configuration.

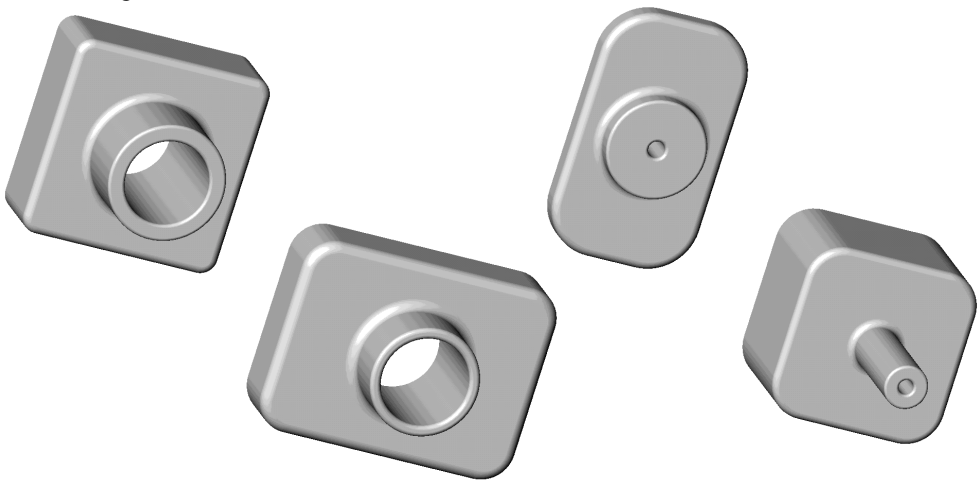
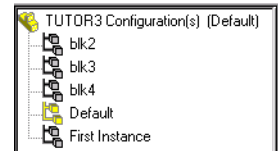

Editing the Design Table

To make changes to the design table:

- 1 Click **Edit, Design Table**.
- 2 Make the desired changes.
- 3 To close the design table, click anywhere in the graphics area outside the design table.

The configurations update as needed to reflect the changes.

TIP: When using this or any other OLE object, you may need to click **Zoom to Fit**  when returning to the SolidWorks window.

Deleting the Design Table

To delete the design table, click **Edit, Delete Design Table**. Deleting a design table does *not* delete the configurations associated with it.

More about Basic Functionality



The *Mastering the Basics* chapters introduce you to many functions available with SolidWorks 2001. The following pages highlight some additional SolidWorks functionality. For more information, see the *SolidWorks 2001 Online User's Guide*.

Accessing SolidWorks Documents Using Windows Explorer

Windows Explorer offers you the following functionality:

- Thumbnail images.** View thumbnail images of SolidWorks parts and assemblies. The graphic is based on the view orientation of the model when the document was saved.
- Opening documents.** Open a part, drawing, or assembly document.
- Drag and drop.** You can drag and drop:
 - Any SolidWorks document from Windows Explorer into an empty area of the SolidWorks window, not occupied by another document window.
 - A part or assembly from Windows Explorer to an open SolidWorks assembly window to add an instance of the part or sub-assembly to the assembly.
 - A part or assembly from Windows Explorer to an open and empty SolidWorks drawing document to create the standard three views.

Accessing SolidWorks Documents Using Internet Explorer

Internet Explorer version 4.0 or later offers you drag and drop functionality.

You can drag and drop hyperlinks that jump to SolidWorks part files from the Internet Explorer window to:

- The Feature Palette™ window
- A new, empty part document
- A drawing or assembly document
- An empty area of a SolidWorks window

Setting Up Different Views of SolidWorks Documents

There are several ways you can view SolidWorks documents.

- ❑ **Multiple Views of Different Documents.** You can have multiple part, assembly, and drawing document windows open at the same time.

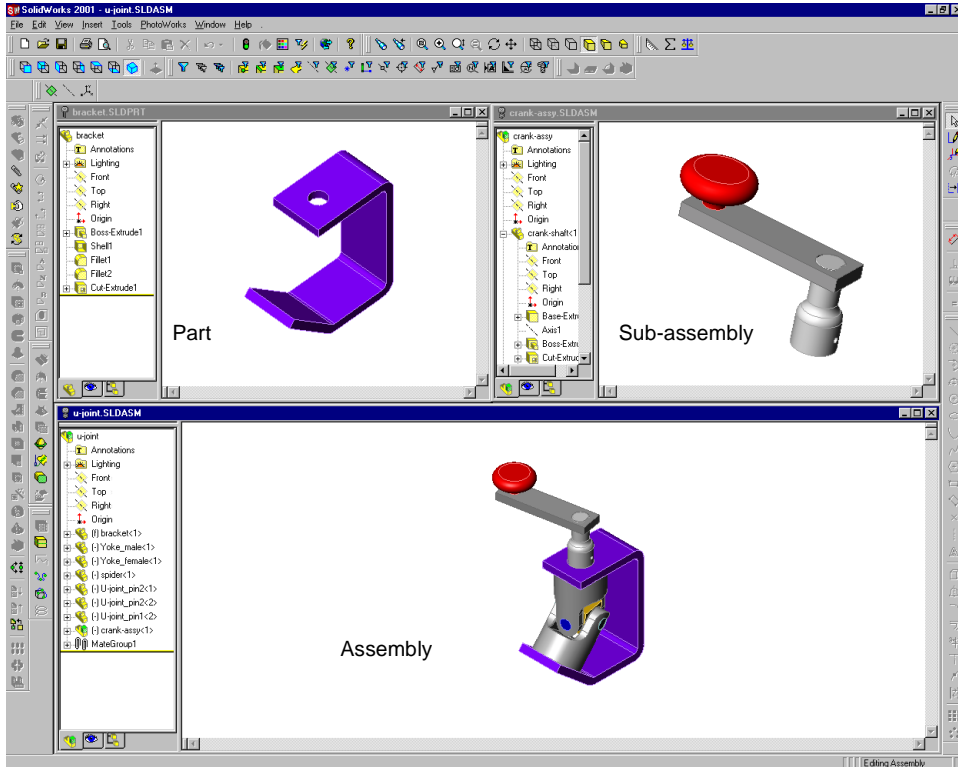

- ❑ **Multiple Views of the Same Document.** You can open additional views of the same document. Selecting an item in one view selects it in all views. For example, when creating a fillet you could select edges on the front of the model in one view and edges on the back in another view.

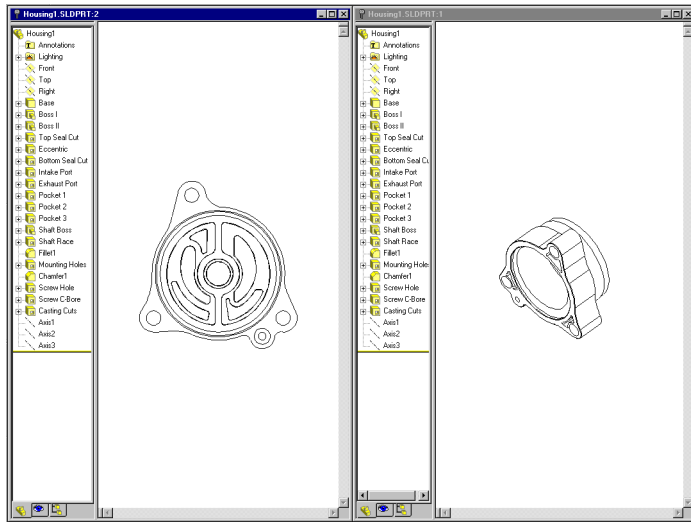

- ❑ **Split Window View.** You can use split controls to split the window into two or four panes. You can zoom, rotate, and set the view mode for each of these views independently.

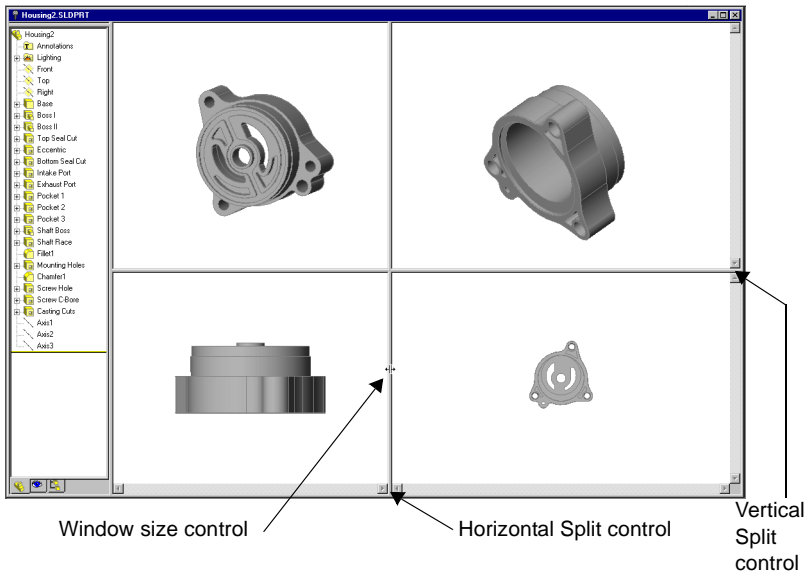

More about Basic Functionality

- Orientation Dialog Box.** You can use the **Orientation** dialog box to:
 - Create your own named views.
 - Switch to any of the standard views, or to two additional views, ***Trimetric** and ***Dimetric**.
 - Change the orientation of all the standard views.
 - Restore all of the standard views to their default settings.

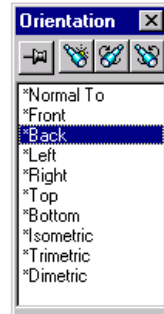

Duplicate Panel Display

You can display a split instance of the panel adjacent to the graphics area, usually the FeatureManager design tree. A split display is *not limited* to duplicate FeatureManager design trees. You can select *any combination* of the following:

- FeatureManager design tree
- PropertyManager
- ConfigurationManager
- Third party applications that use the panel

This option is available either alone or in conjunction with **Window, New Window**. Without opening a new window, you can display the *same* part, assembly or drawing, along with any combination of the panels. With complex designs, for example, you can:



- Display different sections of the part, drawing, or assembly, expanded or collapsed
- View different details for configurations
- Pick different selections from each panel

FeatureManager Design Tree

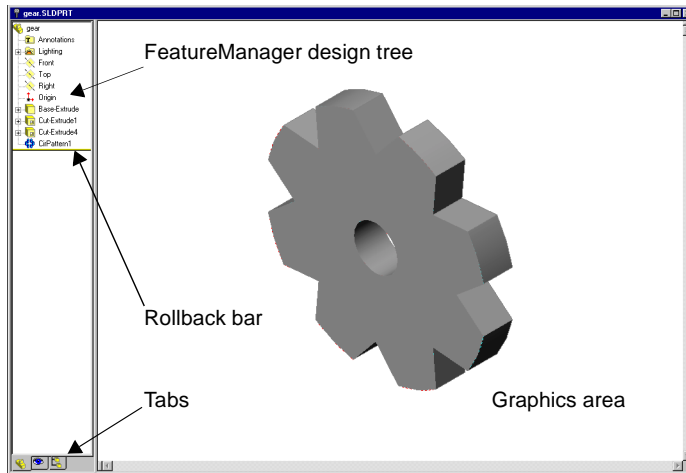
The FeatureManager design tree and the graphics display window are dynamically linked. You can select features, sketches, drawing views, and construction geometry in either pane.



The FeatureManager design tree offers you the following functionality:

- Feature order.** Change the order in which features are rebuilt.
- Feature names.** Change feature names.
- Moving and copying features.** You can move features by dragging them in the model. For example, you can move a hole to a different face. You can also copy or move a fixed-radius fillet or a chamfer using drag-and-drop.
- Dragging and dropping between open documents.** You can drag a part or assembly name from the FeatureManager design tree to a drawing document.
- Suppress/Unsuppress.** Suppress or unsuppress selected features.
- Dimensions.** Display and control the dimensions of a feature.
- Annotations.** Filter, scale, and control the display of annotations using the **Annotations**  folder.
- Lighting.** Adjust the kind and amount of lighting that illuminates a shaded part or assembly using the **Lighting**  folder.
- Rollback bar.** Temporarily roll the model or assembly back to an earlier state using the *rollback* bar.
- Equations.** Add a new equation, edit, or delete an equation using the **Equations**  folder.

More about Basic Functionality

- ❑ **Tabs.** Use the tabs at the bottom of the FeatureManager design tree to show you the current FeatureManager function.



A part or a sketch document is open for editing and viewing.



An assembly is open for editing, adding components, creating configurations, and viewing.



A drawing document is open for viewing or editing.



The PropertyManager functionality is in use.



The ConfigurationManager tab is in use, where you create, select, and view the configurations of a part or assembly.

- ❑ **Symbols.** View symbols to get information about:

- Any parts or features with *external references*. An external reference is a dependency on geometry that exists in another document.
- The state of sketches (over defined, under defined, not solved).
- The state of assemblies and assembly mates.

- ❑ **Rebuild Icon.** The rebuild icon  appears when you are required to rebuild a part.

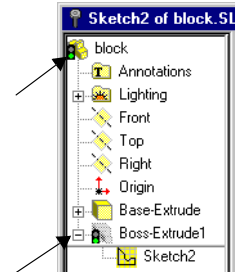

Customizing Toolbars

You can customize your toolbar display.

- Displaying toolbars.** Some toolbars are always displayed; other toolbars display automatically when you open a document of the related type. For example, when you open an assembly document, the Assembly toolbar appears.
- Moving toolbar buttons.** You can move toolbar buttons to different toolbars, change menus, or reset shortcut keys.
- Rearranging toolbars.** You can rearrange toolbars in the SolidWorks window. You can dock them at the edge of the window, or make them floating palettes.

Customizing SolidWorks Functionality Using the Options Dialog Box

The SolidWorks 2001 application lets you customize functionality to suit your needs.

- System Options** tab. Set options, such as system colors and spin box increments, that are stored in the registry and affect all current and future documents.
- Document Properties** tab. Set options, such as grid/snap and units, that apply only to the current document. This tab is available *only* when you have a document open.

Document Templates

Templates are documents (parts, drawings, and assemblies) that include user-defined parameters. Templates allow you to maintain as many different documents for parts, drawings or assemblies as you need. A template can be a blank document, or it can be a part, drawing, or assembly that you saved as a template. For example, you can create:

- A document template using millimeters and another template using inches
- A document template using ANSI and another template using ISO dimensioning standard
- A base part in a document that you use for mold design

When you open a new part, drawing, or assembly, the **New SolidWorks Document** dialog box appears. The dialog box has tabs for you to organize templates, shows you a preview of templates, and allows you to configure the display of templates for any of the tabs. You can also create additional tabs.

Keyboard Shortcuts

Keyboard shortcut keys are available for many menu items. Look for the underlined letters in the main menu bar.

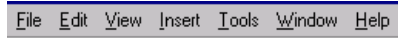

Also, look for the underlined letter for each of the menu items. When the menu is pulled down, pressing an underlined letter activates the related command.

Some commands also have shortcut keys that are displayed on the menu beside the command. For example, the combination **Ctrl + N** opens a new file.

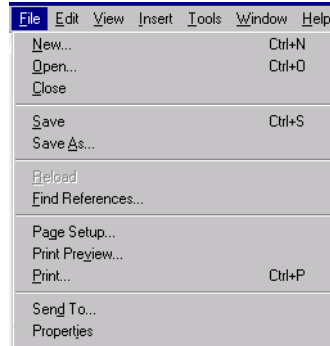

You can customize the keyboard shortcut keys to suit your style of working.

The following table lists the default keyboard shortcuts for rotating and viewing your model

Action	Key Combination
Rotate the model:	
• horizontally or vertically	Arrow keys
• horizontally or vertically 90 degrees	Shift + Arrow keys
• clockwise/counterclockwise	Alt + left or right Arrow keys
Scroll the model	Ctrl + Arrow keys
Orientation dialog box	Spacebar
Zoom in	Shift + Z
Zoom out	Z
Zoom to fit	F
Rebuild the model	Ctrl + B
Force rebuild the model and all its features	Ctrl + Q
Redraw the screen	Ctrl + R

Shortcut Menus

Whether you are working with a sketch, a part, an assembly, or a drawing, you have access to a wide variety of tools and commands from the shortcut menu accessed by pressing the right-mouse button.

As you move the pointer over geometry in the model or over items in the FeatureManager design tree, right-clicking pops up a shortcut menu of commands that are appropriate for whatever you clicked on.

For example, with the shortcut menu, you can:

- Select a sketch tool.
- Open and close sketches.
- Change or view the properties of an item.
- Give a new name to a feature or dimension using the **Properties** dialog.
- Hide** or **Show** a sketch, plane, axis, or assembly component.
- Open an assembly component for editing.
- Access the dimension tools and an annotations menu when in a drawing.
- Find an item in the FeatureManager design tree.

ConfigurationManager Shortcut Menu Options

When you hold down the right mouse button in a blank area with the ConfigurationManager active, you can:

- Open the **Add Configuration** dialog box.
- Open the **Document Properties** tab from the **Options** dialog box directly.

Additional Shortcut Menu Options

You have additional shortcut menu functions, if you prefer using the right mouse button rather than the menu bar. These added functions appear where appropriate. They include:

- Delete** - delete a feature or portion of sketch
- Suppress/Unsuppress** - suppress or unsuppress a feature or a component
- Edit Equation** - edit an equation when you select the driven dimension in the sketch
- Delete** - delete a Bill of Materials (BOM) in a drawing
- Open** - open a part file or a top-level assembly over drawings
- Mate** - mate components in an assembly
- Move Component** - move a component in an assembly

Middle Mouse Button Functions

With a three-button mouse, you can dynamically use the following view commands:

- Pan all document types - Click the middle mouse button and hold down **Ctrl**.
- Rotate part or assembly - Click the middle mouse button.
- Zoom all document types - Click the middle mouse button and hold down **Shift**.

NOTE: In an active *drawing*, to *pan* you can use the middle mouse button with or without holding down **Ctrl**.

If you use a three button mouse, you may need to install the appropriate software or configure the device through Windows Program Manager. Consult the documentation included with your mouse.

Working with Dimensions

The following dimensioning tips may save you some time.

- Using the Modify box as a calculator.** You can type values and arithmetic symbols directly into the box to calculate the dimension.



NOTE: You do not have to type the units, such as mm or in.

- Editing dimension positions.** You can:
 - Hide a dimension.
 - Move or copy a dimension to another view in a drawing.
 - Center the dimension text between the witness lines.
- Editing circular feature dimensions.** You can:
 - Change a *radius* dimension to a *diameter* dimension.
 - Display a *diameter* dimension as a *linear* dimension.

Display As Radius (default)

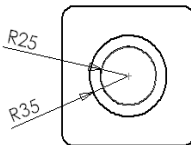

Display As Diameter

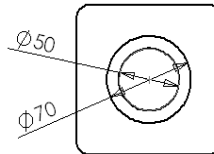

Display As Linear

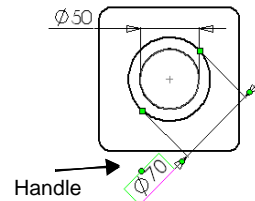

- Modifying leaders, text, and arrows.** You can modify the appearance of leaders, text, and arrows.

Preparing to Print Using Page Setup

Use **File, Page Setup** to set the margins and page orientation that works best with your printer or plotter. This setting applies for all SolidWorks documents that you print, until you change the setup. You can specify the following print options:

- Paper margins**
- Line weights**
- Page orientation**
- Scale - Drawings and Parts/Assemblies**
- Print drawings in color**

You can also use **Page Setup** to create custom headers and footers for individual documents before printing. Options include:

- Select a predefined header or footer
- View your selection in the **Preview** boxes
- Select **Custom Header** or **Custom Footer**
- Select a **Font** style and size for custom-created headers and footers

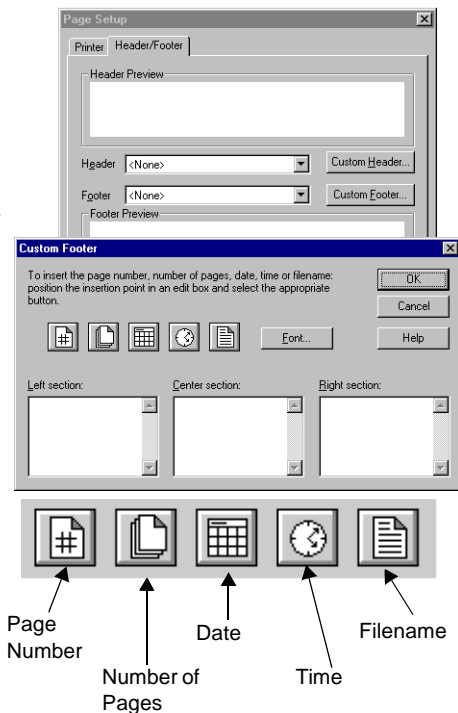

- Include the following in a header or footer:
 - **Page Number**
 - **Number of Pages**
 - **Date**
 - **Time**
 - **Filename**
- View changes before printing the document

What's Wrong?

The SolidWorks application offers a “What’s Wrong” functionality. With this function, you can view information about any errors that occur when rebuilding a part or assembly.

A red circle with a down-pointing arrow next to the part or assembly name at the top of the FeatureManager design tree alerts you that there is a problem. An exclamation mark (!) indicates the item responsible for the error.

Some common errors in rebuilding include:

- ❑ Dangling dimensions or relations – dimensions or relations to an entity that no longer exists
- ❑ Features that cannot be rebuilt, such as a fillet that is too large

The **Rebuild Errors** dialog box displays the rebuild error information.

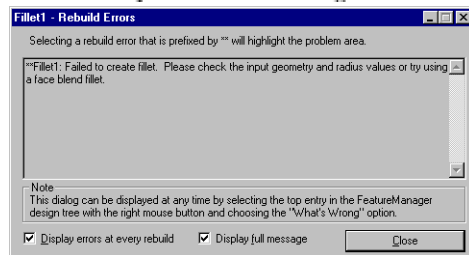
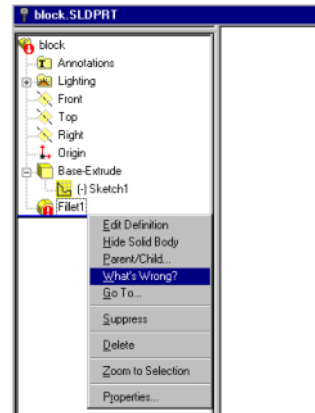

Selection Filter

To make it easier to select specific items, you can set the **Selection Filter** to the kind of item that you want to select. The Selection Filter toolbar offers many selection options.

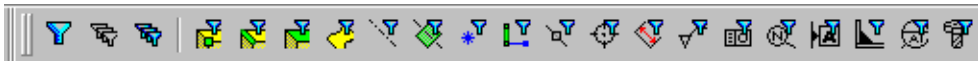

For example, when you are working with parts, you can set the filter to select only faces, edges, or vertices.

You can also set the **Selection Filter** for reference geometry, sketch entities, or dimensions and annotations.

With the filter set, the kinds of items that you specified are identified when you pass the pointer over them. Sometimes they are highlighted, and sometimes the pointer changes shape. This makes it easy for you to select only the items that you intend to select.

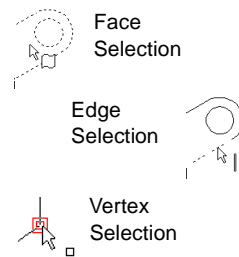



Working with Features and Parts

Revolve and Sweep Features

Loft Features

Pattern Features

Fillet Features

More about Features and Parts



Revolve and Sweep Features





In this chapter, you create the candlestick shown here. This chapter demonstrates:

- ❑ Creating a *revolved* feature
- ❑ Sketching and dimensioning *arcs* and an *ellipse*
- ❑ Creating a *sweep* feature
- ❑ Using *relations*
- ❑ Creating an *extruded cut* feature with a *draft angle*



Sketching a Revolve Profile

You create the base feature of the candlestick by revolving a profile around a centerline.

- 1 Click **New** , select the **Tutorial** tab, and double-click the **Part** icon to open a new part.
- 2 Click **Sketch**  to open a sketch on the **Front** plane.
- 3 Click **Line**  or **Tools, Sketch Entity, Line**. Sketch a vertical line through the origin, and sketch the two horizontal lines as shown.
- 4 Click **Dimension**  or right-click and select **Dimension** from the shortcut menu. Dimension the lines as shown.

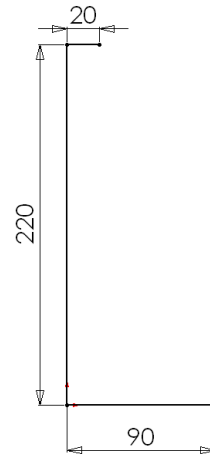

Now sketch and dimension the arcs and lines needed to complete the profile.

- 1 Click **3 Pt Arc**  or **Tools, Sketch Entity, 3 Point Arc**, and point at the endpoint of the top horizontal line.
 - a) Drag an arc downward for a length of approximately 20mm ($L=20$), and release the pointer.
 - b) Then drag the highlighted point to adjust the angle of the arc to 180° ($A=180^\circ$) and the radius to 10mm ($R=10$). Notice that the center point of the arc snaps to the vertical inferencing line.
 - c) Release the pointer.

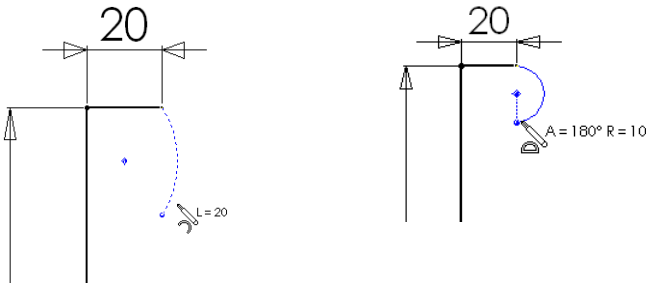

TIP: Watch the pointer for feedback and for *inferencing*. As you sketch, inferencing pointers and lines help you align the pointer with existing sketch entities and model geometry. For more information about inferencing, see the *SolidWorks 2001 Online User's Guide*.

- Click **Line**  or right-click and select **Line**, then sketch a vertical line starting at the lower endpoint of the arc.

Do not dimension the line at this time.

- Click **3 Pt Arc**  or right-click and select **3 Point Arc**, and sketch an arc with the following measurements: length of 40mm, angle of 180° , and radius of 20mm.

Sketch the arc so that the arc endpoints are coincident with the line.

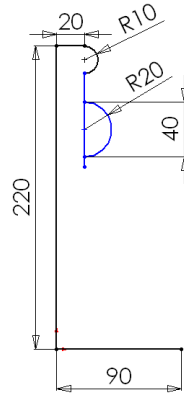



- Click **Trim**  or **Tools, Sketch Tools, Trim**, and point at the sketch segment between the endpoints of the arc.

The sketch segment is highlighted. Click the highlighted segment to delete it.

- Right-click and select **Dimension** from the shortcut menu. Dimension the upper vertical line to 40mm.
- Click **Add Relation**  or **Tools, Relations, Add**. The **Add Geometric Relations** dialog box appears.

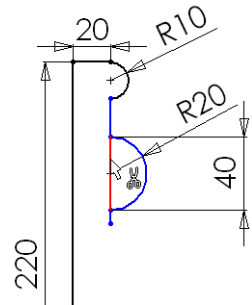
- Click the vertical lines on each side of the arc.
- Select **Equal** in the **Add Geometric Relations** dialog box.
- Click **Apply**, then click **Close**.



- Click **Tangent Arc**  or **Tools, Sketch Entity, Tangent Arc**, and point at the endpoint of the lower vertical line. Drag the arc until the angle is 90° and the radius is 60mm. Release the pointer.
- Sketch another tangent arc. Drag the arc until the endpoint is coincident with the endpoint of the bottom horizontal line.

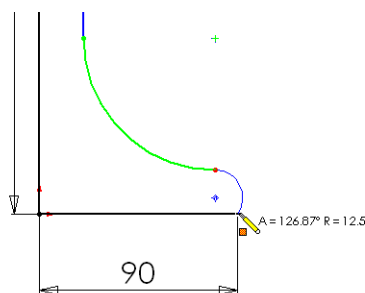
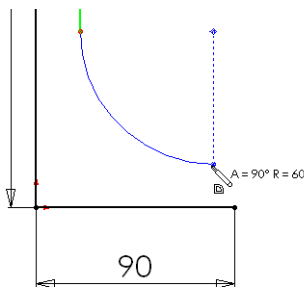

Working with Features and Parts

- 9 Dimension the rest of the sketch as shown.



When you are done dimensioning, the sketch is fully defined. (All lines and endpoints are black.)

- 10 Click **Centerline**  or **Tools, Sketch Entity, Centerline**, and sketch a vertical centerline through the origin.

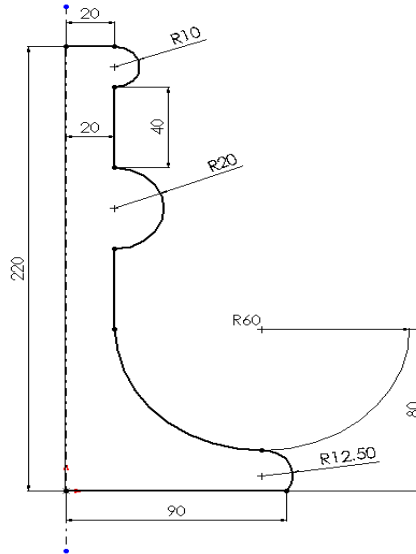
This centerline is the axis around which the profile revolves.



Creating the Revolve Feature





- 1 Click **Revolved Boss/Base**  on the Features toolbar, or **Insert, Base, Revolve**.
The **Base-Revolve** PropertyManager appears.
- 2 Leave the default values of **Revolve Type** as **One-Direction**, and **Angle**  at 360°.
- 3 Click **OK** .
- 4 Save the part as **Cstick.sldprt**.



Sketching the Sweep Path

A sweep is a base, boss, or cut created by moving a *section* along a *path*. In this example, you create the candlestick handle by using a sweep.

First, you sketch the sweep path. The path can be an open curve, or a closed, non-intersecting curve. Neither the path nor the resulting sweep may self-intersect.

- 1 Click the **Front** plane in the FeatureManager design tree, then click **Sketch**  to open a new sketch.
- 2 Click **Front**  on the Standard Views toolbar, and click **Hidden Lines Removed**  on the View toolbar.
- 3 Click **View, Temporary Axes**. Notice that the temporary axis of the revolved base appears.
- 4 Right-click and select **Line**. Point at the temporary axis.
The pointer changes to  indicating that the pointer is exactly on the temporary axis.
- 5 Sketch a horizontal line as shown, and dimension the line to 60mm.
- 6 Select **Tangent Arc** from the shortcut menu, and sketch an arc. Dimension the arc to a radius of 150mm.

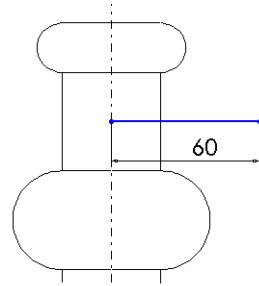

TIP: If the centerpoint of a radial dimension is out of view, right-click the dimension, and select **Properties**. Select the **Foreshortened radius** check box, then click **OK**.

- 7 Select the endpoints of the tangent arc, and set the vertical dimension to 65mm.

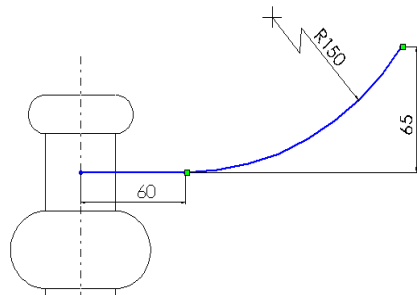

TIP: As you move the pointer, the dimension snaps to the closest orientation. When the preview indicates the dimension type and location you want, right-click to lock the dimension type. Click to place the dimension.

- 8 Select **Tangent Arc** from the shortcut menu, and sketch another arc as shown. Dimension it to a radius of 20mm.

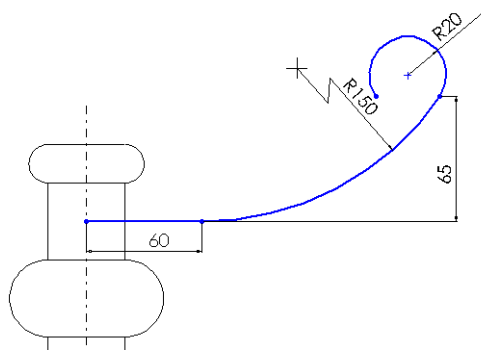

- 9 Click **Add Relation**  or **Tools, Relations, Add**. The **Add Geometric Relations** dialog box appears.
- Click the endpoints of the tangent arc you just sketched.
 - Make sure that **Horizontal** is selected in the **Add Geometric Relations** dialog box.
 - Click **Apply**, then click **Close**.

The dimensions and relations prevent the sweep path from changing size and shape when moved.

- 10 Click **Display/Delete Relations**  or **Tools, Relations, Display/Delete**.

The **Display/Delete Relations** dialog box appears. It lists all of the relations in the current sketch, including relations that are added automatically as you sketch and relations that you add manually.

- 11 In the **Display relations by** box, make sure that **Criteria** is selected, and that **All** is selected in the **Criteria** box.

- 12 Using the **Next**  or **Previous**  buttons, view each relation.

- 13 When **Type** is **Coincident**, click the **Entities** tab, then click each item listed beneath **Entity**.

The coincident relation was added automatically between the sweep path and the revolved base. The line entity is related to an entity outside the current sketch. The **External information** section lists the external entity to which the line entity has a relation. The point entity exists in the current sketch.



- 14 Click **Close**.

Next, dimension the sweep path with respect to the revolved base.

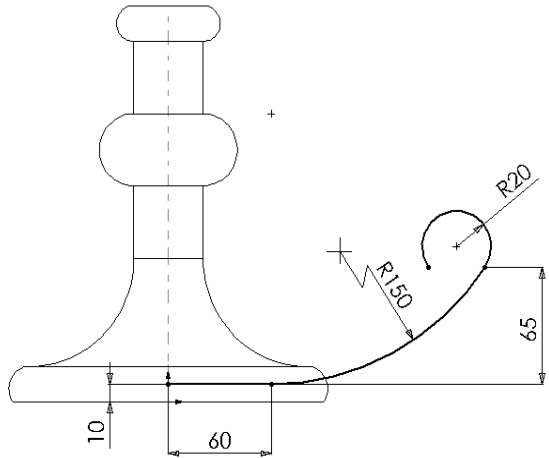

- 1 Dimension the horizontal line of the sweep path and the bottom edge of the revolved feature to 10mm.
The sweep path is fully defined.
- 2 Close the sketch.



Sketching the Sweep Section

- 1 Select the **Right** plane from the FeatureManager design tree, then click **Sketch**  to open a new sketch.
- 2 Click **Normal To**  on the Standard Views Toolbar.
- 3 Click **Ellipse**  or **Tools, Sketch Entity, Ellipse**, and sketch an ellipse anywhere.

TIP: To sketch an ellipse, drag horizontally from the center point of the ellipse to set the width of the ellipse, release the pointer, then drag vertically to set the height.

- 4 Dimension the ellipse as shown.
- 5 Click **Add Relation**  or **Tools, Relations, Add**.
- 6 Click both side points of the ellipse and add a **Horizontal** relation. This relation ensures that the ellipse is not slanted.
- 7 Click **Isometric** .

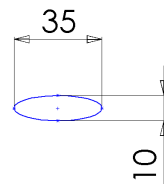

- 8 Click the center point of the ellipse and the endpoint of the horizontal line of the sweep path. Click **Coincident**, click **Apply**, and click **Close**.

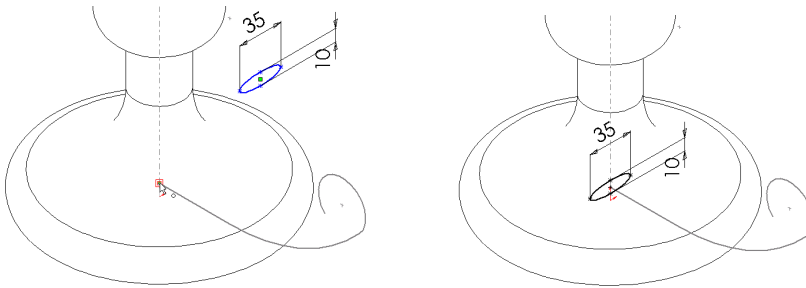





This coincident relation ensures that the center point of the sweep section lies on the plane of the sweep path.

- 9 Click **View, Temporary Axes** to hide the temporary axis.
- 10 Close the sketch.

Creating the Sweep









Now you combine the two sketches to create the sweep.

- 1 Click **Sweep**  or **Insert, Boss, Sweep**.
The **Base-Sweep** PropertyManager appears.
- 2 Under **Profile and Path**, make sure the ellipse, **Sketch3**, appears in **Profile** . If it is not displayed, click the ellipse in the graphics area.
- 3 Click **Path** .and select the path, **Sketch2**, in the graphics area.
Note how the colors in **Profile and Path** match those in the graphics area.
- 4 Under **Options**, make sure the **Orientation/twist control** is set to **Follow Path**.
- 5 Click **OK**  to create the sweep.
The candlestick's handle is complete.
- 6 Save the part.



Creating the Cut

Create a cut to hold a candle.



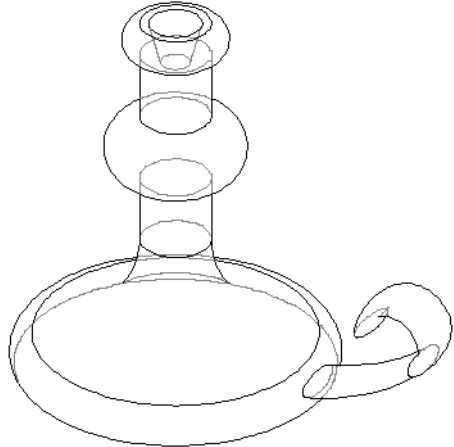
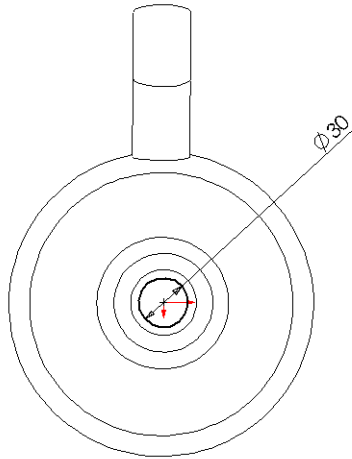

- 1 Click the top face of the revolved base feature, then click **Sketch** .
- 2 Click **Normal To** .
- 3 Click **Circle**  or **Tools, Sketch Entity, Circle**, and point at the sketch origin. Sketch and dimension a circle as shown.
- 4 Click **Extruded Cut**  or **Insert, Cut, Extrude**. Under **Direction 1**, do the following:
 - Leave **End Condition** as **Blind**.
 - Set **Depth**  to 25mm.
 - Click **Draft While Extruding** , and specify an **Angle** of 15°.
- 5 Click **OK** .
- 6 To see the angled cut, click **Hidden In Gray** , and rotate the part using the arrow keys.





Adding the Fillets

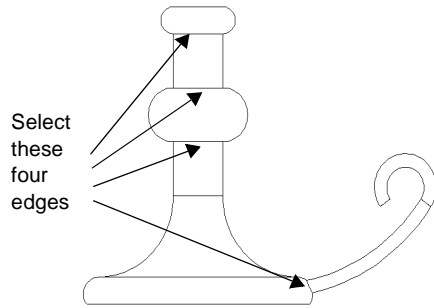

Add fillets to smooth some of the edges on the part.

TIP: Use the **Selection Filter** to make selecting the edges in this section easier.

- 1 Click **Front** , and click **Hidden Lines Removed** .
- 2 Click **Fillet**  or **Insert, Features, Fillet/Round**.
The **Fillet Feature** PropertyManager appears.
- 3 Under **Fillet Type**, leave the default **Constant radius**.
- 4 Under **Items to Fillet** set **Radius**  to 10mm.
- 5 Click the four edges indicated.



Notice the list of edges in the **Edge fillet items**  box. If you click the wrong edge accidentally, click the edge in the graphics area again to deselect it, or select the name of the edge in the **Edge fillet items** box and press **Delete**.

- 6 Click **OK** .
- 7 Click **View Orientation** , and double-click ***Trimetric** in the **Orientation** dialog box.

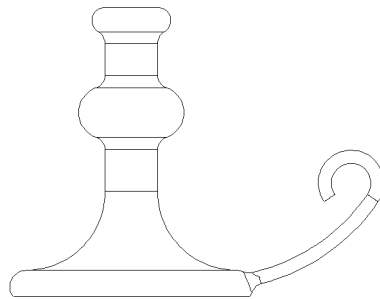

- 8 Click **Shaded** .
- 9 Save the part.



Loft Features

In this chapter, you create this chisel using *loft* features.

A loft is a base, boss, or cut created by connecting multiple cross sections, or *profiles*.

This exercise demonstrates the following:

- ❑ Creating *planes*
- ❑ Sketching, copying, and pasting the *profiles*
- ❑ Creating a solid by connecting the profiles (*lofting*)

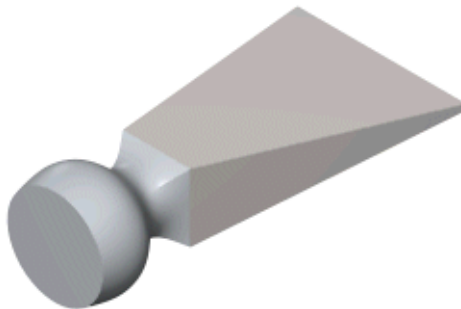

Setting Up the Planes

To create a loft, you begin by sketching the profiles on faces or planes. You can use existing faces and planes, or create new planes. For this example, you use one existing plane and create several new planes.

- 1 Click **New** , select the **Tutorial** tab, and double-click the **Part** icon to open a new part.

By default, the planes in a SolidWorks model are not visible. However, you can display them. For this example, displaying the **Front** plane is helpful.

- 2 Click **View**, make sure **Planes** is selected, then right-click the **Front** plane in the FeatureManager design tree. Select **Show** from the shortcut menu. (To make it easier to see the planes as you add them, click **View Orientation** , and double-click ***Trimetric**.)

- 3 With the **Front** plane still selected, click **Plane**  on the Reference Geometry toolbar, or click **Insert, Reference Geometry, Plane**.

- 4 Select **Offset** and click **Next**.

- 5 Set the **Distance** to 25mm, and click **Finish**.

A new plane, **Plane1**, is created in front of the **Front** plane.

The planes used in a loft do not have to be parallel, but for this example they are.

- 6 With **Plane1** still selected, click **Plane**  again, and add another offset plane at a distance of 25mm (this is **Plane2**).

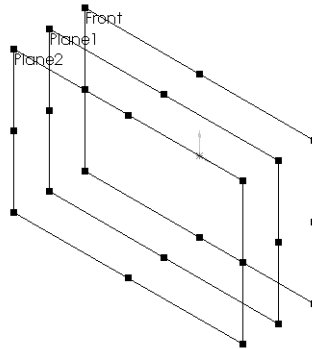

- 7 Another way to create an offset plane is to copy an existing plane. Select **Plane2** in the graphics area, hold down **Ctrl**, and drag to a location in front of **Plane2**. Drag the *edge* or the *label*, not the handles. (Dragging the *handles* changes the size of the plane display.)

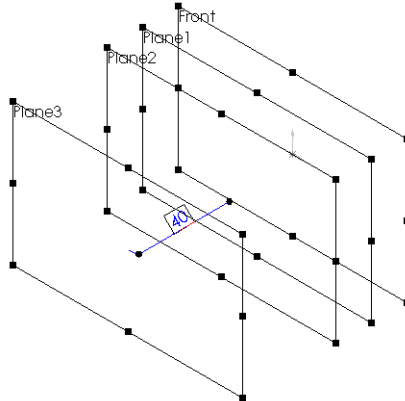

Another offset plane, **Plane3**, is created.

- 8 To set the offset distance for the new plane, double-click **Plane3**, change the dimension value to 40mm, and click **Rebuild** .



Sketching the Profiles

You create the chisel handle by lofting between simple profile sketches.

- 1 Click the **Front** plane either in the FeatureManager design tree or the graphics area, and click **Sketch** . Change the view orientation to **Front** .
- 2 Sketch and dimension a 60mm square as shown.

TIP: To center the dimension text between the witness lines, right-click the dimension, and select **Display options, Center text**. If you move the dimension, the text remains centered (unless you drag the text outside the witness lines).

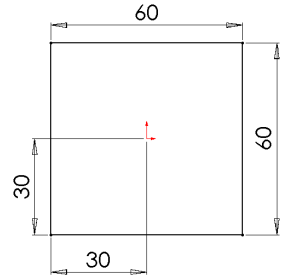

- 3 Exit the sketch.
- 4 Open a sketch on **Plane1**, and sketch a circle, centered on the origin.
It appears as though you are sketching on top of the first sketch. However, the first sketch is on the **Front** plane, and it is not affected by sketching on **Plane1**, a parallel plane in front of it.
- 5 Dimension the circle to 50mm in diameter.

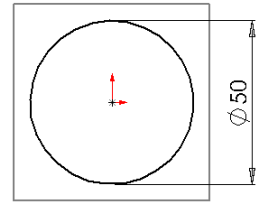

- 6 Exit the sketch.
- 7 Open a sketch on **Plane2**, and sketch a circle, centered on the origin. As you drag, make the diameter of the circle coincident with the vertex of the square. (Watch for the  pointer.)
- 8 Exit the sketch.

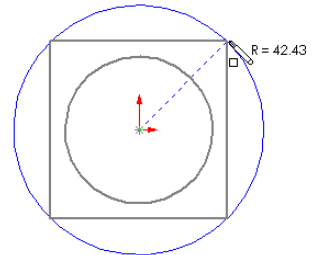



Copying a Sketch

You can copy a sketch from one plane to another to create another profile.

- 1 Click **Isometric**  to see how the sketches line up.

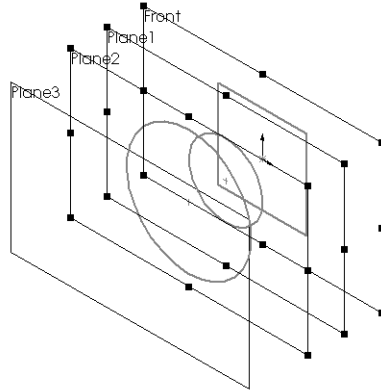
TIP: If a sketch is on the wrong plane, you can change the plane. Right-click the sketch, select **Edit Sketch Plane**, then click the new plane for the sketch in the FeatureManager design tree.



- 2 Click **Sketch3** (the larger circle) in the FeatureManager design tree or the graphics area.
- 3 Click **Copy**  on the Standard toolbar, or click **Edit, Copy**.
- 4 Click **Plane3** in the FeatureManager design tree or the graphics area.
- 5 Click **Paste**  on the Standard toolbar, or click **Edit, Paste**.

When you paste a sketch on a plane, a new sketch is created automatically on that plane.

- 6 Save the part as **loft.sldprt**.

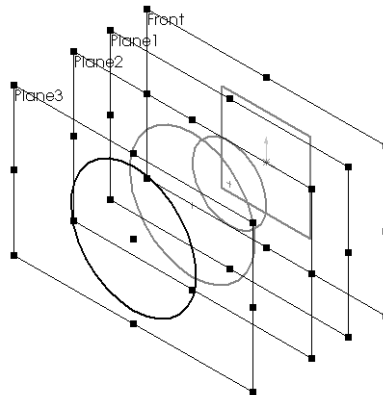

Create the Loft

Now use the **Loft** command to create a solid feature based on the profiles.

- 1 Click **Loft**  or **Insert, Base, Loft**.
- 2 In the graphics area, select each sketch. Click near the same place on each profile (the lower-right side, for example), and select the sketches in the order you want to connect them.

A preview shows you how the profiles will be connected; the system connects the points or vertices on the profile closest to where you click.

- 3 Examine the preview.
 - If the sketches appear to be connected in the wrong order, you can use the **Up** or **Down** buttons in the **Loft** dialog box to rearrange the order.
 - If the preview indicates that the wrong points will be connected, right-click in the graphics area, select **Clear Selections**, and select the profiles again.
- 4 Click **OK**  to create a solid base feature.

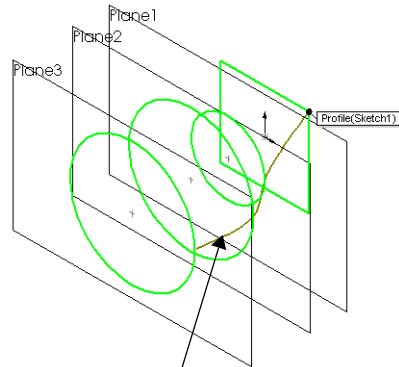

Preview shows how profiles will be connected

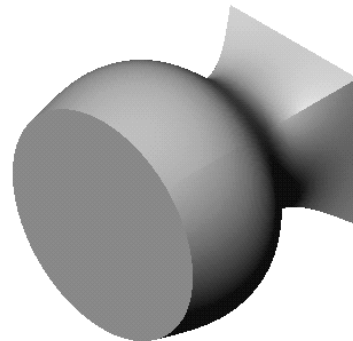



Creating a Boss Loft

For the pointed end of the chisel, you create another loft.

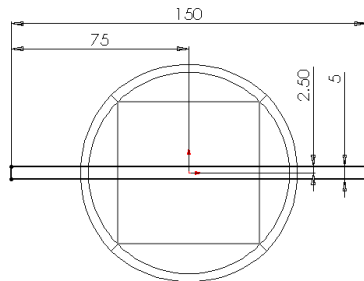
- 1 If the **Front** Plane is not displayed in the graphics area, click the **Front** plane in the FeatureManager design tree. Hold down **Ctrl**, and drag the **Front** plane to create an offset plane *behind the original Front* plane.
- 2 Right-click the new plane, **Plane4**, and select **Edit Definition**. In the **Offset Plane** dialog box, set the **Distance** to 200mm, make sure that **Reverse Direction** is selected, and click **Finish**.
- 3 Open a sketch on **Plane4**. Sketch and dimension a narrow rectangle as shown.
- 4 Exit the sketch.



- 5 Change to **Isometric**  view, and click **Loft** , **Insert, Boss, Loft**.
- 6 Right-click the side of the loft, and click **Select Other** to pick the square, as shown. Then click the lower part of the narrow rectangular sketch. Examine the preview to verify that the correct vertices will be connected.

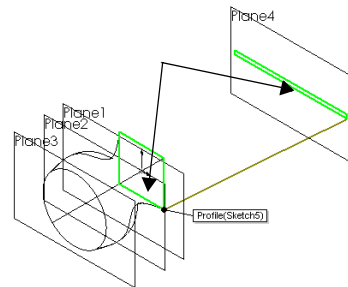

TIP: To select an edge or face that is behind the near surface (a hidden edge or face), right-click and choose **Select Other** from the shortcut menu.

The **Yes/No** pointer  appears. When you point and right-click (**N**), you cycle through the edges or faces under the pointer, highlighting each of them in turn.

When the edge or face that you want is highlighted, click (**Y**).

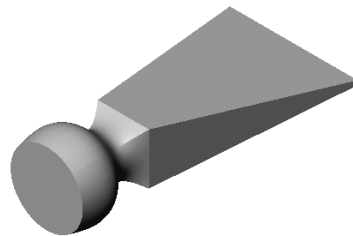

- 7 Click **OK**  and save the part.

Pattern Features

In this chapter, you learn how to create a *linear pattern* and a *circular pattern*. A linear pattern is a one- or two-dimensional array of features. A circular pattern is a circular array of features.



The steps include:

- Creating a revolved base feature
- Using mirroring to create a feature
- Creating a linear pattern
- Deleting and restoring an instance of the linear pattern
- Creating a circular pattern
- Using an equation to drive the circular pattern



Creating the Revolved Base Feature

In this example you create a housing for a microphone. Because the housing is cylindrical, you can create the housing as a revolved feature.

- 1 Click **New** , select the **Tutorial** tab, and double-click the **Part** icon to open a new part.
- 2 Open a sketch on the **Front** plane.
- 3 Sketch and dimension the profile as shown.
- 4 Click **Fillet**  on the Sketch Tools toolbar.
 - a) Set **Radius** to 30mm.
 - b) Leave **Keep constrained corners** selected so that the corner dimensions and relations are retained to a virtual intersection point.
 - c) Select the endpoint of the 50mm vertical line that is coincident with the endpoint of the diagonal line.
 - d) Click **Close**.

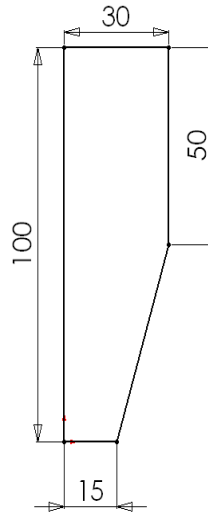





The corner is filleted away.



- 5 Sketch a vertical **Centerline**  through the origin.

The centerline is the axis around which the profile revolves.





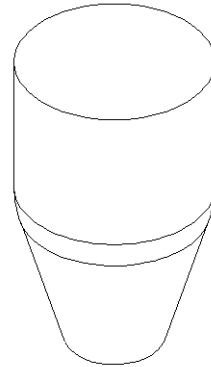
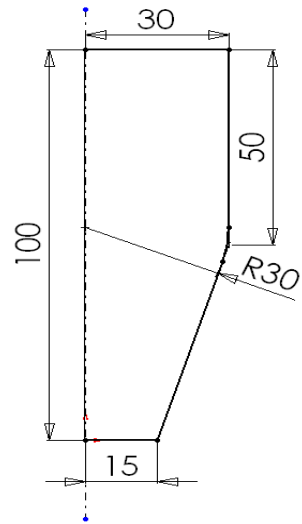



- 6 Click **Revolved Boss/Base**  on the Features toolbar, or click **Insert, Base, Revolve**.
- 7 Under **Revolve Type** leave the value as **One-Direction**, and under **Direction 1** , leave the value of 360° .
- 8 Click **OK**  to create the revolved base.
- 9 Click **Hidden Lines Removed** .

- 10 Click **Save** , and save the part as **Mhousing.sldprt**.



Extruding a Thin Feature

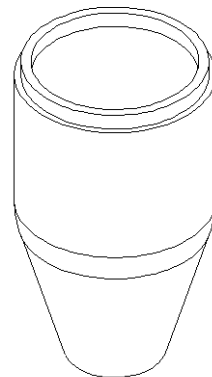
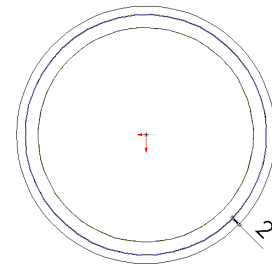
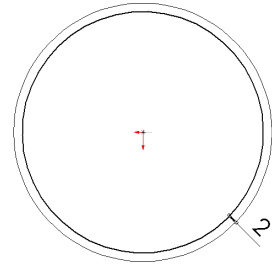

Now, create a thin-walled extrusion for the microphone capsule.

- 1 Select the top face and open a sketch.
- 2 Click **Top**  to change the view orientation.
- 3 Click **Offset Entities** .
- 4 Under **Parameters**, do the following:
 - a) Set the **Offset Distance** to 2mm.
 - b) Select the **Reverse** check box to offset the edge to the inside.
- 5 Click **OK**  to exit the **Offset Entities** PropertyManager.
- 6 Click **Extruded Boss/Base**  or **Insert, Boss, Extrude**.
- 7 Under **Direction 1** do the following:
 - a) Leave **End Condition** as **Blind**.
 - b) Specify a **Depth**  of 5mm.
- 8 Select the **Thin Feature** check box and do the following:
 - a) Click **Reverse Direction**  to extrude the wall to the inside.
 - b) Leave **Type** as **One-Direction**.
 - c) Set **Wall Thickness**  to 3mm.
- 9 Click **OK**  to create the thin-walled extrusion.
- 10 Save the part.





Shelling the Part

Hollow out the part by removing the top and bottom faces.

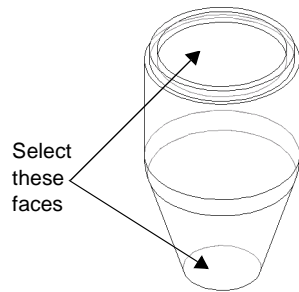
- 1 Click **Hidden In Gray** .
- 2 Click **Shell**  or **Insert, Features, Shell**.
- 3 Under **Parameters**, do the following:
 - a) Set **Thickness** to 3mm.
 - b) Click the **Faces to remove** , then click the top and bottom faces as shown. Use **Select Other** from the shortcut menu to select the lower face.





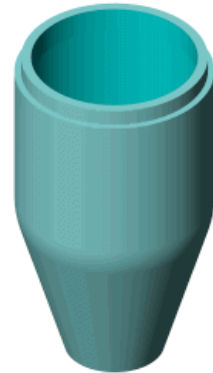

- 4 Click **OK** .
- 5 To see the shelled part better, click **Shaded**  and rotate the part.



Creating an Oblong Cut

Next you create a profile of an oblong on a reference plane. Use mirroring to take advantage of symmetry and to decrease the number of relations needed to fully define the sketch.

- 1 Click **Hidden Lines Removed** .
- 2 Open a sketch on the **Front** plane, and click **Normal To** .
- 3 Click **Centerline** , and sketch a vertical centerline through the origin.
- 4 Click **Line** , and sketch two horizontal lines of equal length, beginning at the centerline. Watch for the on-curve pointer  that indicates when you are exactly on the centerline.

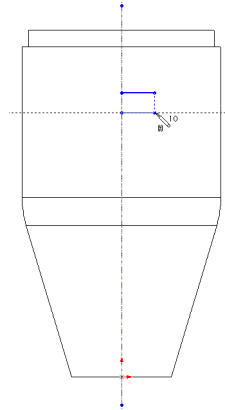

- 5 Click **3 Pt Arc**  or right-click and select **3 Point Arc**. Create a 3-point arc as shown. Adjust the angle of the arc to 180°. Then press **Esc** to deselect the 3-point arc tool.

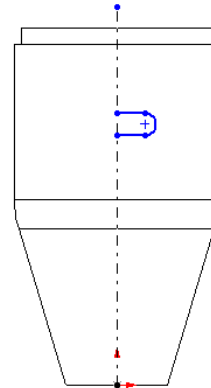

- 6 Mirror the sketch entities.
 - a) Hold down **Ctrl**, and select the centerline, both horizontal lines, and the 3-point arc.
 - b) Click **Mirror**  on the Sketch Tools toolbar, or click **Tools, Sketch Tools, Mirror**.

- 7 Dimension the oblong as shown.

Now that the sketch is fully defined, create the cut.

- 8 Click **Isometric** .

- 9 Click **Extruded Cut**  or **Insert, Cut, Extrude**.

The **Cut-Extrude** PropertyManager appears.

- 10 Under **Direction 1**, set **End Condition** to **Through All**.

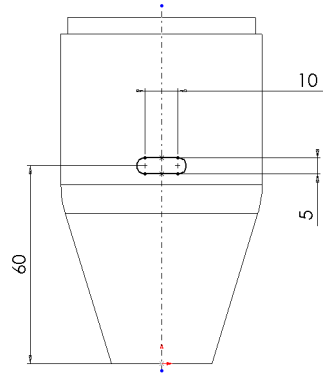

- 11 Click **OK**  to create the cut.

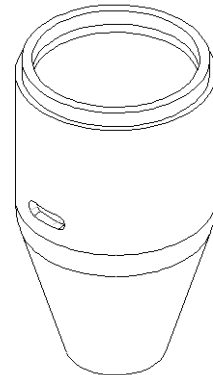





Creating the Linear Pattern

Next create a linear pattern of the oblong cut. You use a vertical dimension to specify the direction in which to create the linear pattern.

- 1 Double-click **Cut-Extrude1** in the FeatureManager design tree.

The dimensions of the **Cut-Extrude1** feature appear in the graphics area.

- 2 Click **Linear Pattern**  on the Features toolbar, or click **Insert, Pattern/Mirror, Linear Pattern**.
- 3 Under **Direction 1**, set the following:
 - a) In the graphics area, click the 60mm dimension as the **Pattern Direction**.
 - b) If necessary, click **Reverse Direction**  so the arrow in the graphics area points up.
 - c) Set **Spacing**  to 10mm. This value is the distance from a point on one instance of the patterned feature to the corresponding point on the next instance.
 - d) Set the **Number of instances** to 4. This value includes the original cut-extrude feature.
- 4 Under **Features to Pattern** , make sure that **Cut-Extrude1** is listed.
- 5 Under **Pattern Options**, select the **Geometry pattern** check box.

The Geometry pattern option speeds up the creation and rebuilding of the pattern. Individual instances of the feature are copied, but not solved.

For more information about **Geometry pattern**, see “Features” in the *SolidWorks 2001 Online User’s Guide*.

- 6 Click **OK**  to create the linear pattern.
- 7 Save the part.

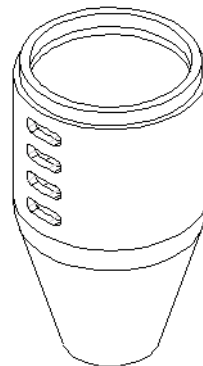
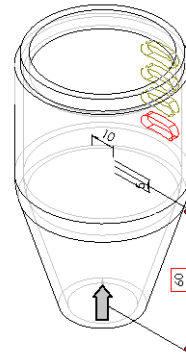

Creating a Circular Pattern of a Linear Pattern

Now create a circular pattern of the linear pattern, using a temporary axis as the axis of revolution.



- 1 Click **View, Temporary Axes**.
- 2 Click **Circular Pattern**  on the Features toolbar, or click **Insert, Pattern/Mirror, Circular Pattern**.

The **Circular Pattern** PropertyManager appears.

Under **Pattern Parameters**, set the following:

- a) In the graphics area, click the temporary axis that passes through the center of the revolved feature.

Axis <1> appears in the **Pattern Axis** box. If necessary, click **Reverse Direction**  so the arrow in the graphics area points up.

- b) Set **Spacing** to 120°.
- c) Set **Number of Instances** to 3.
- 3 Under **Features to Pattern** , make sure that **LPattern1** is listed.
- 4 Under **Pattern Options**, select the **Geometry pattern** check box.
- 5 Click **OK**  to create the circular pattern.

A circular pattern of the linear pattern is created around the part's axis of revolution.

- 6 Click **View, Temporary Axes** to turn off the display of axes, then click **Shaded** .

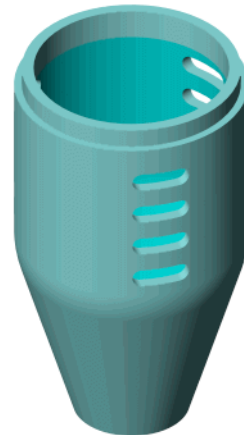
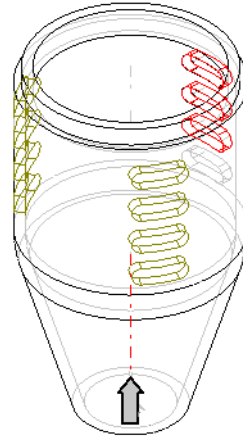

NOTE: If you need to use a circular pattern in a part that does not have a temporary axis in the desired place, you can create an axis, or you can use a linear edge as an axis. For more information about creating an axis, see “Reference Geometry,” in the *SolidWorks 2001 Online User’s Guide*.

Using an Equation in the Pattern

You can use an equation to drive the circular pattern. In this example, the equation calculates the spacing angle by dividing 360° by the number of instances desired. This creates a full circle of equally spaced patterns.

- 1 In the FeatureManager design tree, double-click **CirPattern1**.

Two values appear on the part: 3 (total instances) and 120° (spacing angle).

- 2 Click **Equations**  on the Tools toolbar, or click **Tools, Equations**.
- 3 Click **Add** in the **Equations** dialog box.
- 4 Click the spacing angle value (120) on the part. (You may have to move the dialog boxes to uncover the dimension.)

The name of the value, **D2@CirPattern1** (the second dimension in the circular pattern), is entered the **New Equation** dialog box.

- 5 Using the calculator buttons in the **New Equation** box, enter **= 360 /** (or type **=360/**).
- 6 Click the total instances value (3). **D1@CirPattern1** is added to the equation.



The equation should look as follows:

"D2@CirPattern1" = 360 / "D1@CirPattern1"

- 7 Click **OK** to complete the equation, and click **OK** again to close the **Equations** dialog box.

An **Equations** folder  is added to the FeatureManager design tree. To add, delete, or edit an equation, right-click the folder, and select the desired operation.

Now test the equation.

- 1 Increase the total instances of the circular pattern from three to four.
 - a) Double-click the total instances value (3).
 - b) Set the value in the **Modify** dialog box to 4.
- 2 Click  in the **Modify** dialog box to rebuild the model, then click  to save the current value and to close the **Modify** dialog box.

– or –

Press **Enter**, then click **Rebuild**  on the Standard toolbar, or click **Edit, Rebuild**.

- 3 Save the part.

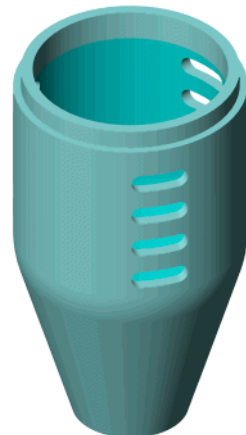

Fillet Features

This chapter describes how to use different types of fillets. In this example, you create a knob by:

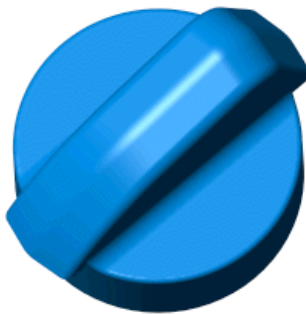

- Using *relations* in your sketches
- Adding *draft* angles to extruded features
- Adding fillets
 - *face blend*
 - *constant radius*
 - *variable radius fillets*
- Using *mirroring* to assure symmetry
- Using *circular patterns* with *equal spacing*



Creating the Base





You can capture the symmetry of the knob in the design intent of the part. You build one half of the part, then mirror the model to create the other half. Any changes you make to the original half are reflected in the other half.

When you relate features to the origin and the planes, you need fewer dimensions and construction entities. You can more easily modify the part when you build it this way.

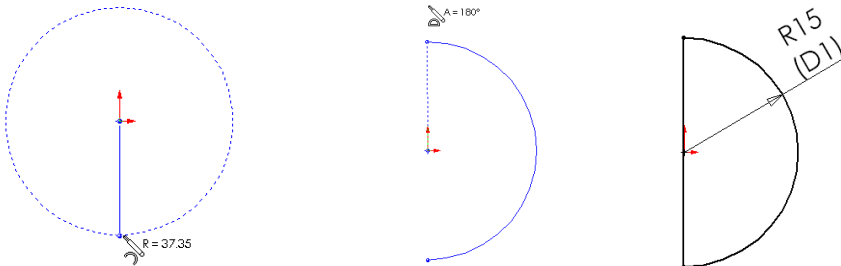
- 1 Click **New** , select the **Tutorial** tab, and double-click the **Part** icon to open a new part.
- 2 Open a sketch on the **Front** plane.
- 3 Sketch a centerpoint arc.
 - a) Click **Centerpoint Arc**  on the Sketch Tools toolbar, or click **Tools, Sketch Entity, Centerpoint Arc**.
 - b) Drag downward from the origin. A circumference guideline appears.
 - c) Drag an arc 180° counterclockwise around the origin.

TIP: The pointer changes to  when a 180° arc exists.







- 4 Connect the arc endpoints with a vertical line.
- 5 Dimension the arc radius to 15mm.
- 6 Select the line, hold down **Ctrl**, click the origin, click **Add Relation** , and add a **Midpoint** relation.
- 7 Click **Extruded Boss/Base**  or **Insert, Base, Extrude**.
- 8 Under **Direction 1** do the following:
 - a) Set **End Condition** to **Blind**.
 - b) Set **Depth**  to 10mm.
- 9 Click **OK**  to create the extrude.



Creating the Grip

Now, create the grip of the knob.

- 1 Change the view orientation to **Right** .
- 2 Click the **Right** plane, and open a sketch.
- 3 Sketch four lines as shown to create the profile. Do not create any inferred perpendicular relations between lines.
- 4 Add a **Collinear** relation between the vertical sketch line and the model edge.
- 5 Dimension as shown.
- 6 Click **Extruded Boss/Base**  or **Insert, Boss, Extrude**.
- 7 Under **Direction 1** do the following:
 - a) Set **End Condition** to **Blind**.
 - b) Set **Depth**  to 5mm.
- 8 Click **OK**  to create the extrude

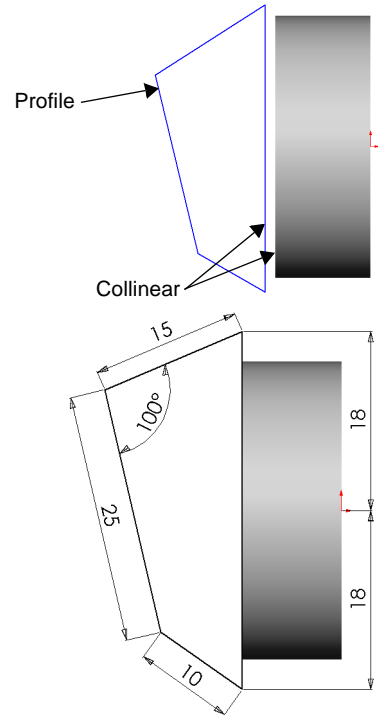

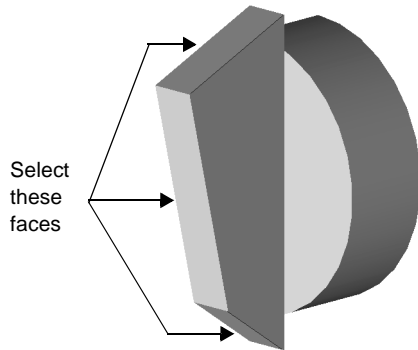

Adding Draft to the Grip

- 1 Change the view orientation to ***Dimetric**.
- 2 Click **Draft**  on the Features toolbar, or click **Insert, Features, Draft**.
 - Leave **Type of draft** as **Neutral Plane**.
 - Set **Draft angle** to 10°.
 - Select the **Right** plane as **Neutral plane**.
 - Click **Faces to draft**, and select the three faces shown.
- 3 Click **OK** to create the drafts and to close the dialog box.



Creating a Face Blend Fillet

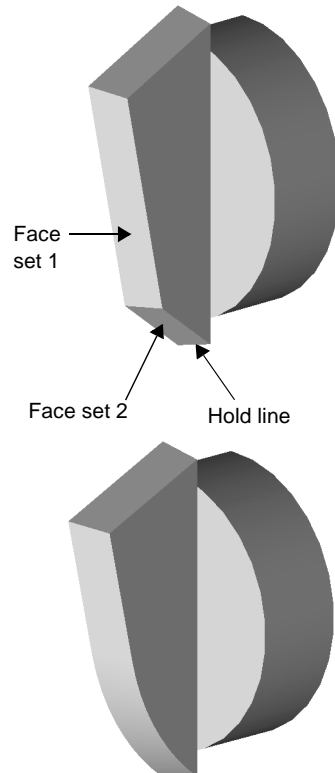

Next, blend some of the faces using a face blend fillet with a hold line. This type of fillet removes the faces that share an edge with the hold line. The distance between the hold line and the selected edges determines the radius of the fillet.

- 1 Click **Fillet**  or **Insert, Features, Fillet/Round**.
- 2 Under **Fillet Type** select **Face fillet**.
- 3 Under **Items to fillet**, do the following:
 - a) Click **Face set 1**, and select the face labeled **Face set 1**.
 - b) Click **Face set 2**, and select the face labeled **Face set 2**.
- 4 Under **Fillet options**, click **Hold lines**, and select the edge labeled **Hold line**.
- 5 Click **OK** .
- 6 Save the part as **Knob.sldprt**.



Creating Constant Radius Fillets

Now, round some of the edges using a series of constant radius fillets.

- 1 Click **Fillet**  or **Insert, Features, Fillet/Round**.
 - a) Select the edge of the grip labeled **5.00mm**.
 - b) Under **Fillet Type** leave as **Constant Radius**.
 - c) Under **Items to fillet**, set **Radius**  to 5mm.
 - d) Click **OK** .

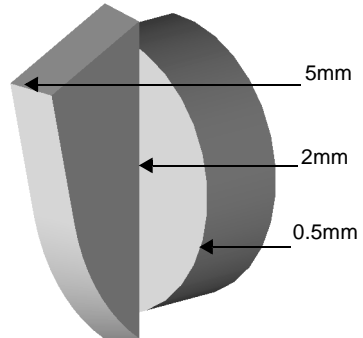

- 2 Repeat Step 1 to add fillets to the edges labeled **2mm** and **0.5mm**. Change the radius values to match the values of the labels.

TIP: When filleted edges intersect, it is good practice to add the larger fillet first.

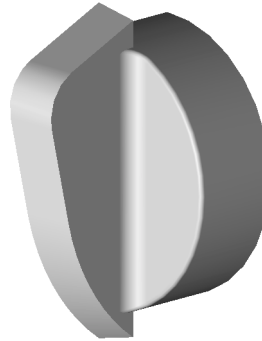

Creating a Variable Radius Fillet

- 1 Click **Fillet**  or **Insert, Features, Fillet/Round**.
- 2 Under **Fillet Type** select **Variable Radius**.
- 3 Select the four edges shown here.

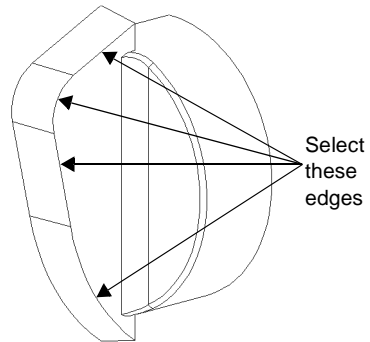

- 4 Under **Variable radius parameters**, set the radius values  for the five vertices as shown in the illustration.

- a) Click **V1**  in the **Vertex List**.
- b) Change the value in the **Radius** box to match the value of the label.
The value for **V1** appears in the list.
- c) Click each vertex in the **Vertex List**, and change the value to match the label.

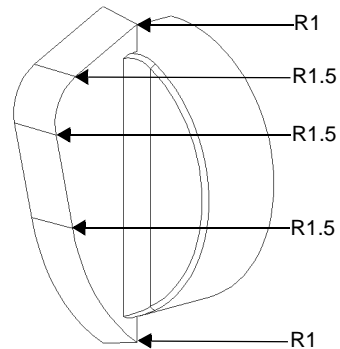

- 5 Click **OK**  to close the **Fillet Feature** dialog box.

TIP: To verify the radius values, double-click **VarFillet1** in the FeatureManager design tree.

- 6 Save the part.

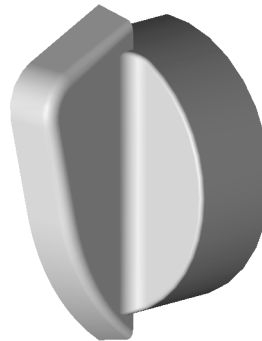

Mirror the Model

To take advantage of the part's symmetry and to finish the part, mirror the part about the planar face that is coincident with the **Right** plane.

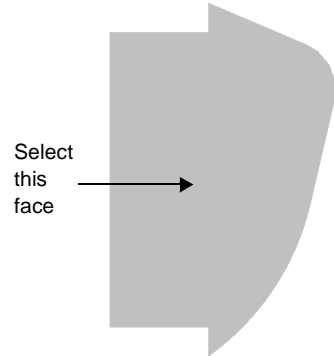

- 1 Change the view orientation to **Left** .
- 2 Click **Insert, Pattern/Mirror, Mirror All**.
- 3 Select the planar face shown.
- 4 Click **OK**.

A mirror image of the original part is joined to the part at the selected face to make a complete, symmetrical part.



Fillet the Parting Line

When you mirrored the drafted grip, it created a parting line along the top of the grip. Smooth the parting line by adding a constant radius fillet.

- 1 Change the view orientation to ***Dimetric**.
- 2 Click **Fillet**  or **Insert, Features, Fillet/Round**.
 - a) Select the edge shown.
 - b) Under **Fillet Type** leave as **Constant Radius**.
 - c) Under **Items to fillet**, set **Radius**  to 5mm.

Select this edge

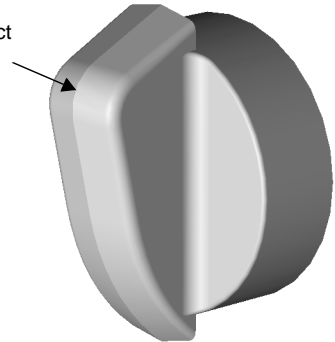

- d) Make sure **Tangent propagation** is selected.

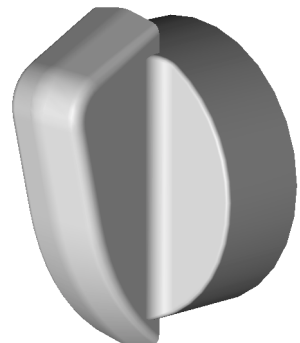

The fillet extends along all of the segments of the edge.

- 3 Click **OK** .





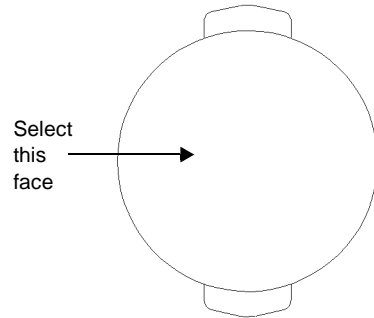

Creating a Thin-Walled Body

Now remove material from the round base of the knob to create a thin-walled body.

- 1 Change the view orientation to **Back** .
- 2 Select the back face of the knob, and open a sketch.
- 3 With the back face still selected, click **Offset Entities**  or **Tools, Sketch Tools, Offset Entities**.
- 4 Under **Parameters**, set **Offset** to 1mm, and select **Reverse** to offset the edge to the inside.
- 5 Click **OK** .



- 6 Change the view orientation to **Isometric** .
- 7 Click **Extruded Cut**  or **Insert, Cut, Extrude**.
- 8 Under **Direction 1**, do the following:
 - a) Set **End Condition** to **Offset From Surface**.
 - b) Click **Face/Plane**  and select the face shown.
 - c) Set **Offset distance**  to 1mm.
- 9 Click **OK** .

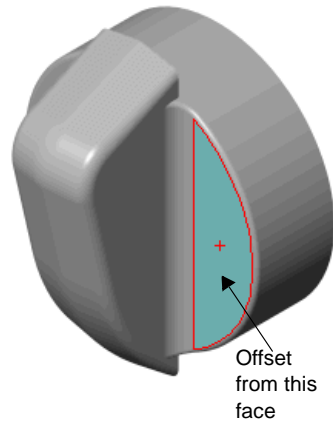





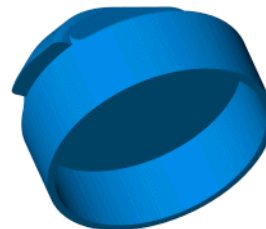



TIP: Using **Offset Entities** and **Offset From Surface** ensures that the wall thickness remains 1mm, even if you change the base diameter or base depth.

- 10 To examine the part, click **Rotate View**  and rotate the part.
- 11 Save the part.



Using Equal Spacing in a Circular Pattern

To add a pattern of bosses inside the knob, use a circular pattern with equal spacing. With the equal spacing option, you specify the number of instances and the total angle, and the software calculates the spacing.

- 1 Change the view orientation to **Back**  and open a sketch on the narrow circular face.
- 2 Sketch a horizontal centerline through the left side of the narrow circular face and the origin, and click **Mirror**  or **Tools, Sketch Tools, Mirror**.
- 3 Sketch a line from the inner edge of the narrow circular face towards the origin, at a slight angle, as shown.
- 4 Click **Mirror**  to turn mirroring off, and sketch a vertical line to connect the two endpoints closest to the origin.
- 5 Click the inside edge of the circular face and click **Convert Entities**  or **Tools, Sketch Tools, Convert Entities**.
- 6 Click **Trim** , or **Tools, Sketch Tools, Trim** and select the large arc to trim the circle.
- 7 Dimension as shown.
- 8 Extrude the sketch as a boss using the **Boss-Extrude** PropertyManager.
- 9 Under **Direction 1**, do the following:
 - a) Set **End Condition** to **Up to Surface**.
 - b) Click **Face/Plane** , and click the inner circular face in the graphics area.
- 10 Click **OK** .
- 11 Click **Rotate View**  to slightly rotate the part to see the extrusion.
- 12 Click **View, Temporary Axes**.

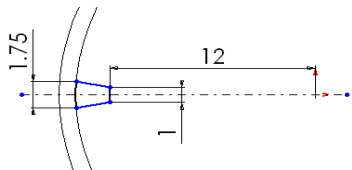
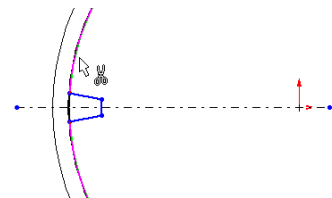
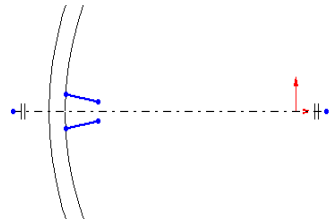

- 13 Make sure the boss is selected and click **Circular Pattern** , or **Insert, Pattern/Mirror, Circular Pattern**.

Under **Pattern Parameters**, do the following:

- a) Click the **Pattern Axis** box, then click the axis through the origin in the graphics area.
- b) Set **Spacing** to 360°.
- c) Set **Number of Instances**  to 7.
- d) Click the **Equal Spacing** check box.

Under **Features to Pattern** , make sure **Boss-Extrude2** is displayed.

Under **Pattern Options**, click to clear **Geometry pattern**, if necessary.

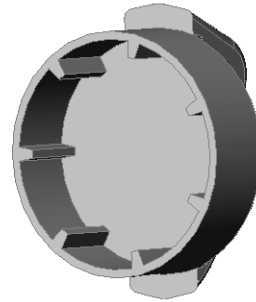

- 14 Click **OK**  and save the part.

For more information about **Geometry pattern**, see “Features” in the *SolidWorks 2001 Online User’s Guide*.

More about Features and Parts



The section “Working with Features and Parts” introduces you to many functions available with SolidWorks 2001. The following pages highlight some additional SolidWorks functionality. For more information, see the *SolidWorks 2001 Online User’s Guide*.

Parts

Parts are the basic building blocks of the SolidWorks mechanical design software. This section highlights some ways to work with parts.

Derived Parts

You can select which configuration of the original part to use for a derived part. The three types of derived parts are: **Base Part**, **Mirror Part**, and **Derived Component Part**.

Check Entity

The check entity function allows you to verify the integrity of a part.

- **Check All** - choose to check the entire body, only the solid model, or only the surface bodies
- **Check Selected items** - select to check more than one entity (face, edge, or surface body) at the same time
- **Maximum edge gap** and **Maximum vertex gap** - report the maximum tolerance between the edges and vertices in the selected items.

The **Found** column displays the number of items found with the specified error, and the **Result list** box displays the items that are either invalid or too short.

Mass Properties

Displays the density, mass, volume, surface area, center of mass, inertia tensor, and principal axes of inertia of a part or assembly model. Capabilities include:

- **Density** - change the density of a part from the **Measurement Options** dialog box.
- **Units** - enter the value using any units, and the software converts the value to the document's units.
- **Updates** - update the mass properties information when you save a document.
- **Coordinate Systems** - calculate mass properties using a coordinate system. The moments of inertia are calculated at the origin of the coordinate system, using its axes.

Section View of a Model

You can display a view of the model cut through the part or the assembly by identifying any combination of planes and planar model faces as section planes.

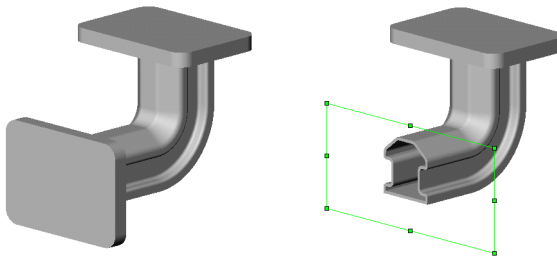

Lighting

With Lighting (in the FeatureManager design tree), you can adjust the direction, intensity, and color of the light in the shaded view of the model. As you change the properties of light, a graphical representation of the light source is displayed and the model is updated. The available light properties depend on the type of light source. Light sources include:

- Ambient**
- Directional**
- Point**
- Spot**

The sample below displays how you can manipulate **Intensity** properties for a **Directional** light source. **Brightness** controls the amount of light. **Specularity** controls the extent to which shiny surfaces exhibit bright highlights where the light strikes them.

Higher values
for **Ambient**
and
Brightness

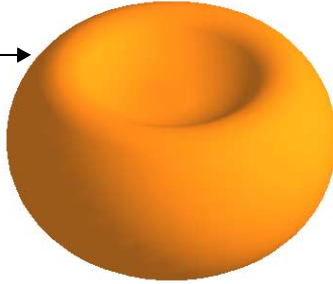

Higher value for
Specularity

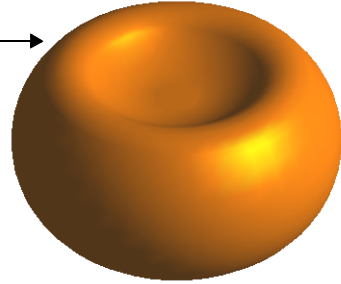

Reference Geometry

Reference geometry defines the shape or form of a surface or solid. Reference geometry includes planes, axes, coordinate systems, and 3D curves.

Planes

You can create any of the following types of planes to facilitate your design intent:



- Offset** - a plane parallel to a plane or face, offset by a specified distance
- At Angle** - a plane through an edge, axis, or sketch geometry at an angle to a face or a plane
- Three Point Plane** - a plane through three points (vertices, points, or midpoints)
- Parallel Plane at Point** - a plane through a point parallel to a plane or face
- Line and Point** - a plane through a line, axis, or sketch line and a point
- Perpendicular to Curve at Point** - a plane through a point and perpendicular to an edge, axis, or sketch curve
- On Surface** - a plane on a non-planar surface

You can do the following to any type of plane:

- Move, resize, and copy
- Change the name
- Hide or show
- Change the plane of a sketch

Coordinate System

You can define a coordinate system for a part or assembly. You can also edit the definition or move the coordinate system to a new location. Use a coordinate system as follows:

- **Measure**  - enables you to measure the size of, or the distance between, entities.
- **Mass Properties**  - displays density, mass, volume, surface area, center of mass, inertia tensor, and principal axes of inertia of a part or assembly model.

Curves

A curve is a type of geometry. Using various methods, you can create several types of 3D curves. One method is the **Projected Curve** . The example below displays how you can create a projected curve using sketches on intersecting planes.

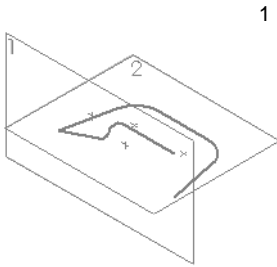

Create sketches on two intersecting planes

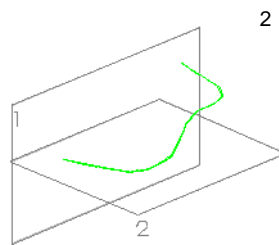

Align sketch profiles projected normal to their sketch planes and create projected curve

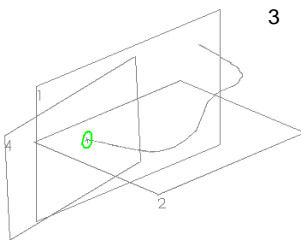



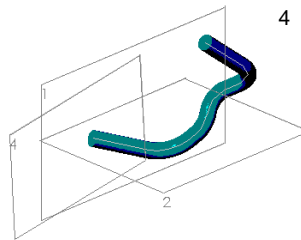

Create profile sketch



Sweep profile sketch along curve

You can also create 3D curves by using the following methods:

- **Composite**  - combining curves, sketch geometry, and model edges into a single curve
- **Helix/Spiral**  - specifying values such as pitch and revolutions for a helix or spiral
- **Split Line**  - projecting sketched curves onto selected model faces
- **Curves Through Reference Points**  - creating 3D spines through points on one or more planes
- **Curves Through Free Points**  - using a point list to create a 3D curve

Features

Features are the individual shapes that, when combined, make up the part. This section describes several SolidWorks features.

- Using additional functionality to some familiar features (such as **Loft** or **Chamfer**)
- Creating patterns that are table driven and sketch driven
- Applying more complex fillets including, multiple radius fillets, round corner fillets, and setback fillets
- Using uniform and non-uniform scaling to edit models

Loft

You can create lofts using various options. For example, you can create a loft using:

- Planar or non-planar profiles
- Parallel or-non parallel planes for the profiles
- Guide curves to connect and control intermediate profiles
- Center line to act as a guide curve, with all profile planes normal to the center line
- Tangency options to control the tangency at the starting and ending profiles

The sample displays combining a non-planar profile and two planar profiles sketched on offset planes.

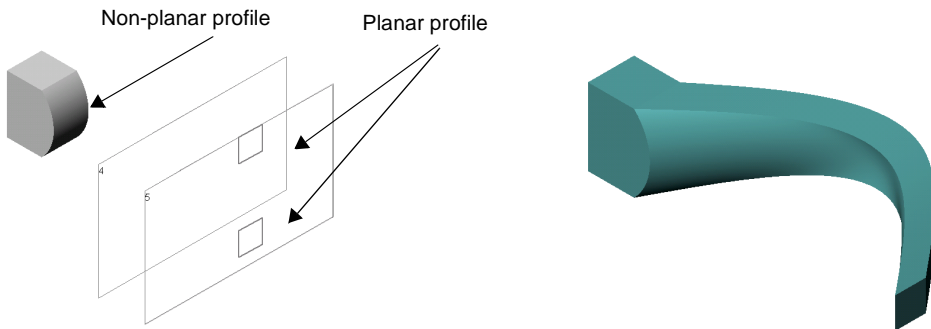

Chamfer

Chamfer creates a beveled edge on the selected edges, faces, or both. You can select from several chamfer types (as shown below), and specify the necessary parameters.

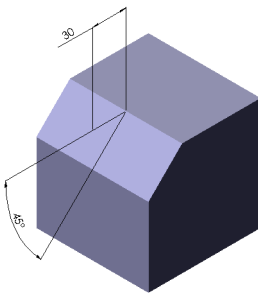

Angle-Distance

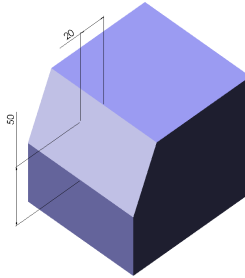

Distance-Distance

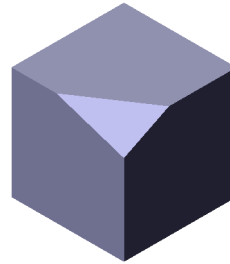

Vertex-Chamfer

Rib

Rib is a special type of extruded feature created from an open sketched contour. It adds material of a specified thickness in a specified direction between the contour and an existing part. You can create a rib using either closed or open sketch elements

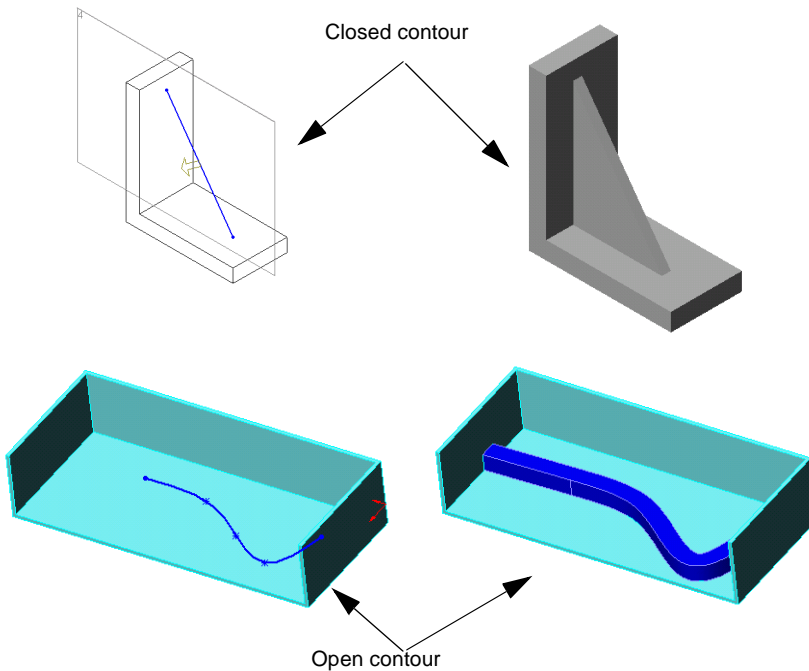

Fillets

There are many different types of fillets. Some of the fillet features not covered in the section “Working with Features and Parts” include:

- Multiple radius fillets
- Setback fillets
- Round corner fillets

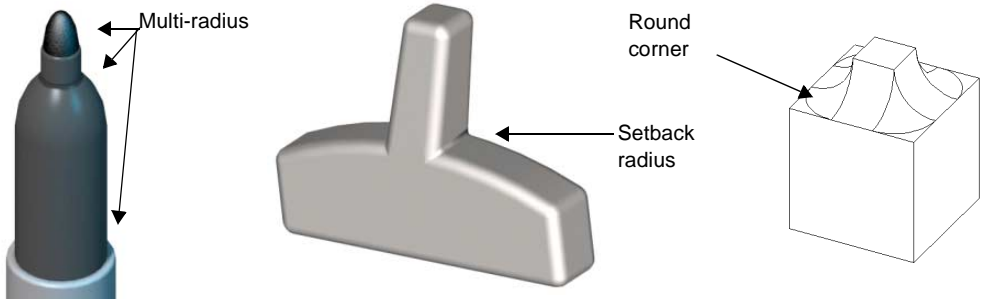

Sketch Driven Patterns

Using sketch points within a sketch, you can specify a feature pattern. You can use sketch driven patterns for holes or other feature instances. Sketch driven patterns use:

- **Seed features** - representing the geometry you want to replicate.
- **Reference point** - using a reference point such as a vertex or a centroid as an origin.
- **Reference Sketch** - representing a sketch on a face of the original part or assembly, sketch points designate the pattern propagation.

Initial pattern instance

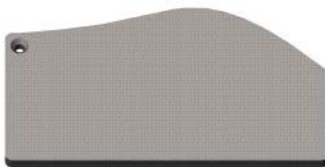

Sketch points for

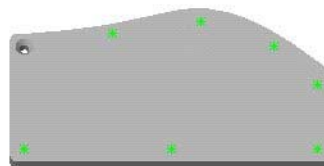

Completed pattern

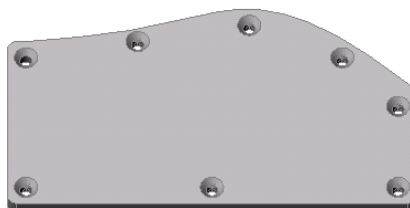
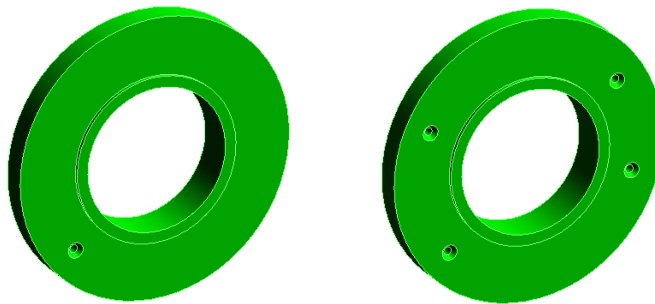

Table Driven Patterns

Using X-Y coordinates, you can specify a feature pattern. Hole patterns using X-Y coordinates are a common application for table-driven patterns. However, you can use other features, such as a boss, with table-driven patterns. You can also save and retrieve the X-Y coordinates of a feature pattern. Like sketch driven patterns, table driven patterns use seed features and reference points. Table driven patterns also use:

- **Coordinate system** - using a coordinate system to act as the point of origin, and defining the X-Y coordinates that populate the table.
- **X-Y points** - designating X-Y coordinates (both positive and negative) in the table, with each coordinate set representing an instance of the pattern.



Scaling

You can select to scale using a coordinate system, the origins or the centroid. You can also select a non-uniform scaling factor by entering X-Y-Z coordinates. For example, you can apply non-uniform scaling by specifying the X-Y-Z coordinates to vary the cavity in a mold.

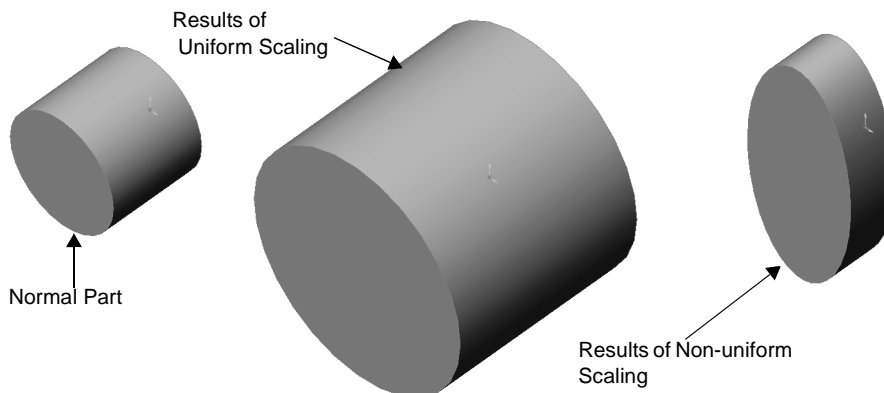





Surfaces

Surfaces are a type of geometry. You can create surfaces, use surfaces to manipulate features, or manipulate the surfaces themselves.

Creating Surfaces

You create surfaces with many of the same tools and principles used to create solids, including:

- **Extrude**  - extrude sketch profile
- **Loft**  - use multiple, parallel or non-parallel planes, with or without guide curves (see the sample below)
- **Sweep**  - create planes to sketch a sweep profile, sweep path, and guide curves
- **Offset**  - offset surface from a lofted model surface (see the example below)

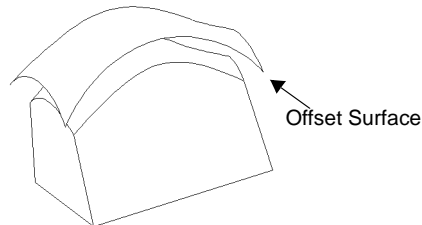

- **Radiate**  - create surfaces by radiating a parting line, an edge, or a set of contiguous edges inwards or outwards, and parallel to a selected plane (see the example below)

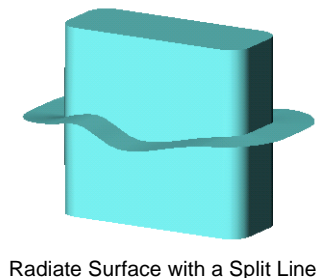
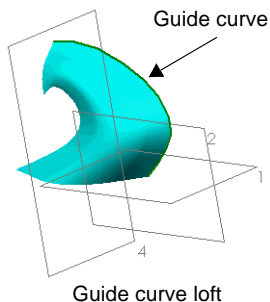

- **Revolve**  - use a surface and revolve about an axis.

Manipulate Features with Surfaces

You can use surfaces to create and manipulate features. This includes:

- **Fill volumes between surfaces** - create a solid body by lofting between two surfaces
- **Thicken surface** - create model geometry by thickening the surface
- **Cut part with surface** - use surfaces to cut parts (see example below)

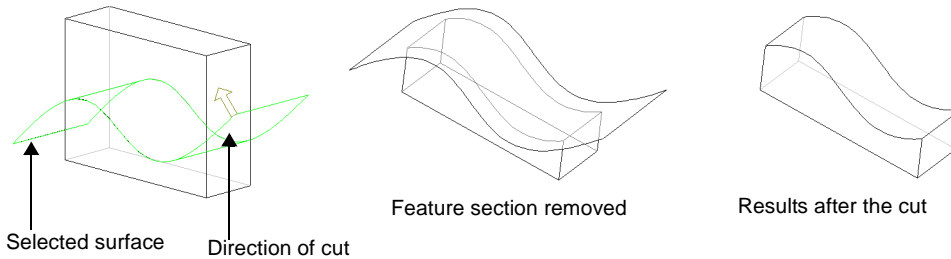



Manipulate Surfaces

You can also manipulate surfaces. Some ways of manipulating surfaces include:

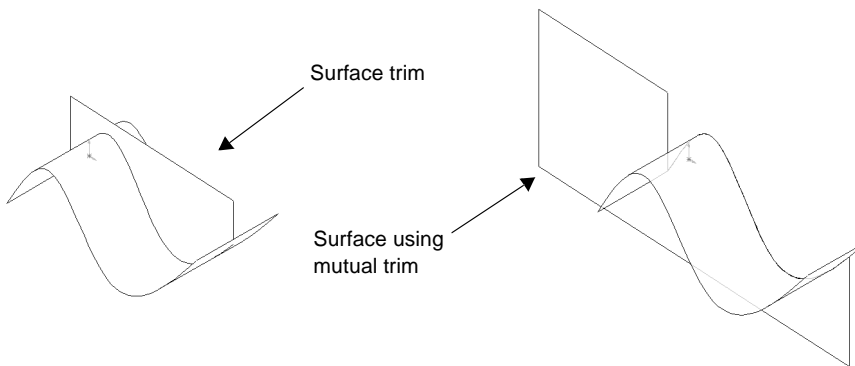
- **Trim**  - use a surface to trim another surface where they intersect, or use multiple surfaces as mutual trim tools.



- **Knit**  - combine two or more surfaces or faces into one.

- **Fillet**  - smooth the edge between adjacent faces in a surface. You can also use **Face Blend** to combine multiple surface bodies, or **Multiple radius fillet** to assign multiple radius values.

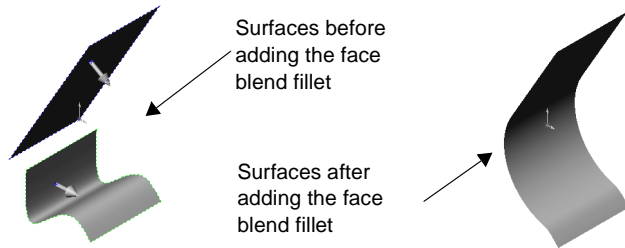

- **Extend**  - extend a surface body by selecting one or more edges or faces.

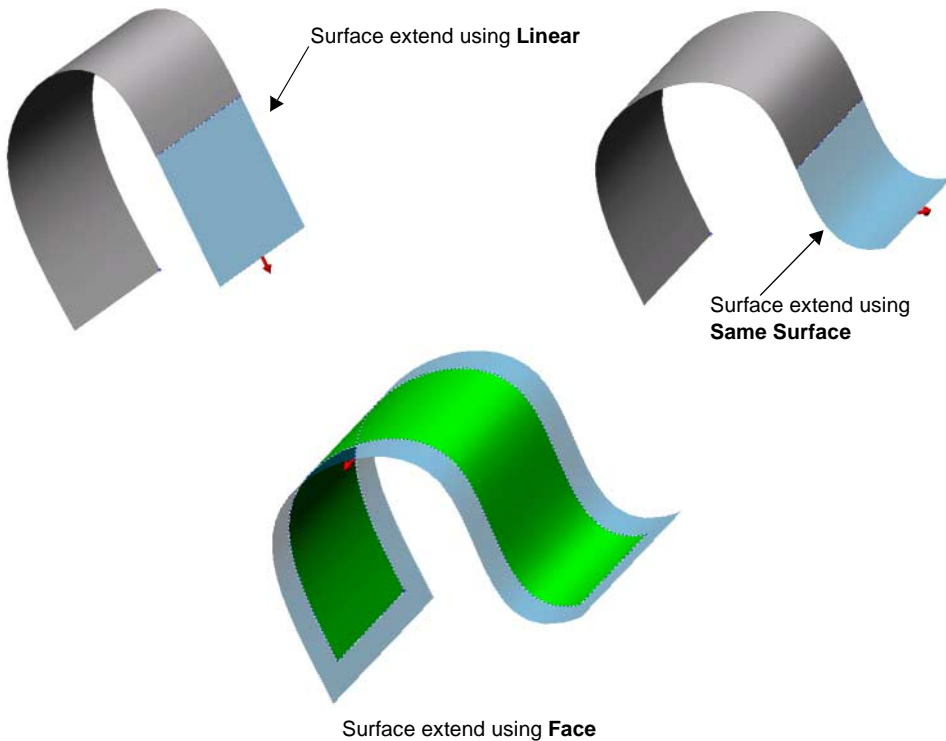



Working with Assemblies

Assembly Mates

Advanced Design Techniques

More about Assemblies

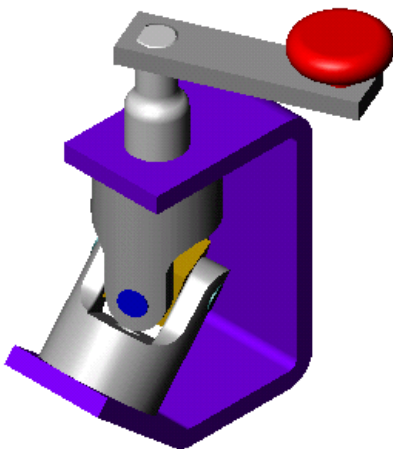

Assembly Mates

This chapter guides you through the creation of the universal joint assembly shown here, and demonstrates the following:

- ❑ Bringing parts into an assembly
- ❑ Using these *assembly mating* relations:
 - Coincident
 - Concentric
 - Parallel
 - Tangent
- ❑ Using *SmartMates*
- ❑ *Testing* mating relations
- ❑ *Exploding* and *collapsing* the assembly

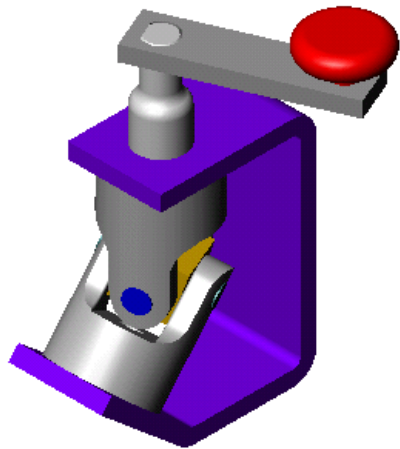

Introduction

This assembly uses the following parts and assembly, located in the *installation directory*\samples\tutorial\universal_joint folder.

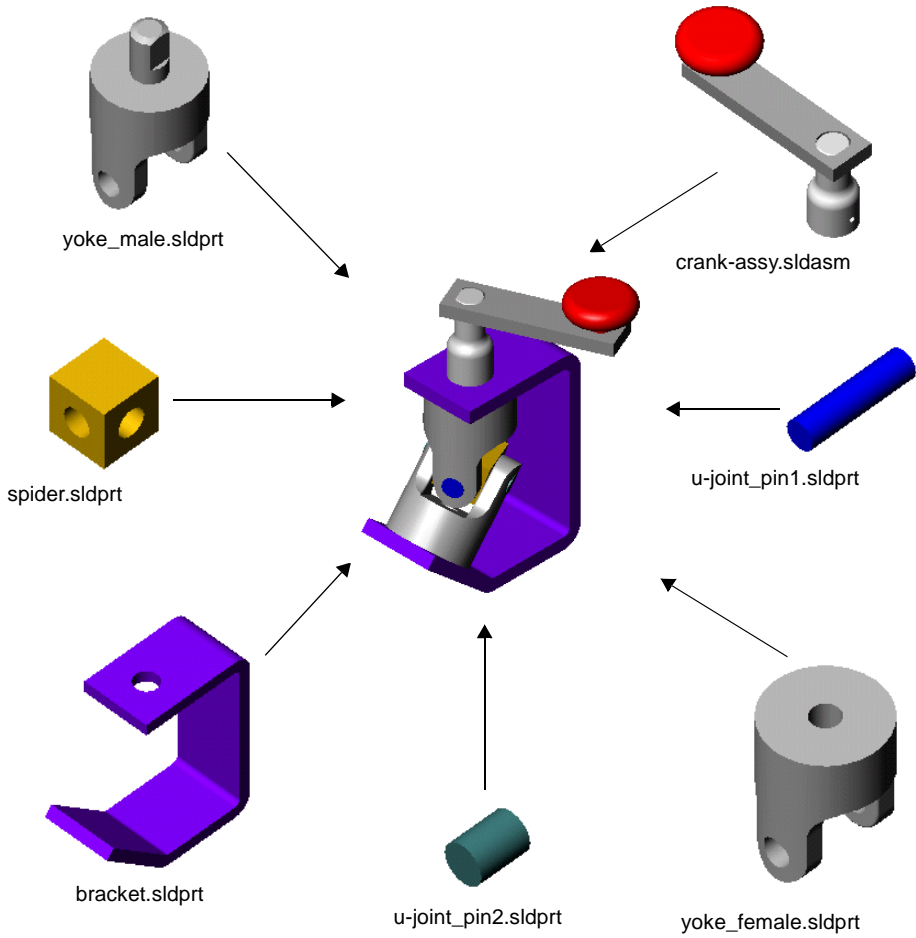

Setting the Assembly Load Option

You can load an assembly with its active components *fully resolved* or *lightweight*.

- **Fully resolved.** All model information is loaded in memory.
- **Lightweight.** A subset of model information is loaded in memory. The remaining model information is loaded if the component is selected or if the component is affected by changes that you make in the current editing session.

You can improve the performance of large assemblies significantly by using lightweight components.

The assembly you build in this chapter includes a sub-assembly whose parts could be loaded lightweight. However, there are no significant benefits in using lightweight parts, for these reasons:

- The sub-assembly is small, consisting of only three simple components.
 - You select two of the three components as you build the assembly, thereby resolving them anyway.
- 1 Before you open the assembly document, click **Tools, Options**. On the **System Options** tab, click **Performance**.
 - 2 Under **Assemblies**, click to clear the **Automatically load parts lightweight** check box, then click **OK**.

For more information about lightweight parts, see the *SolidWorks 2001 Online User's Guide*.

Inserting the First Part into the Assembly

This section describes how to insert a part into the assembly.

- 1 Click **File, Open**, and open **bracket.sldprt**.
- 2 Open a new assembly from the **Tutorial** tab and click **View, Origins** to show the origin.
- 3 Tile the windows so that you can see both the part window and the assembly window.
- 4 Click the part name, **bracket**, at the top of the FeatureManager design tree in the **bracket.sldprt** window. Drag **bracket** into the **Assem1** window, and drop it on the assembly origin in the graphics area. As you drag, watch for the pointer shown here. This pointer indicates an inference to the assembly origin.



When you place a component this way, the *component origin* is located coincident with the *assembly origin*, and the planes of the part and the assembly are aligned. This procedure, while not required, helps you establish an initial orientation for the assembly.

NOTE: You can create this type of inference with any component as you add it to the assembly. You can also create the inference to the assembly origin by dropping the component in the FeatureManager design tree of the assembly window.

- 5 Close the **bracket.sldprt** window, and maximize the **Assem1** window.

Notice that the FeatureManager design tree contains the feature **(f)bracket<1>**. Because this is the first component inserted into the assembly, **bracket** is fixed (**f**). It cannot be moved or rotated unless you float (unfix) it. The **<1>** means that this is the *first instance* of **bracket** in the assembly.

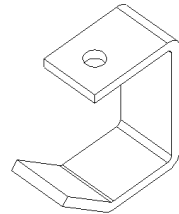

The assembly also contains an empty **MateGroup1** feature. This feature is a placeholder for the mates that you add later.

- 6 Click **Isometric** , and click **Hidden Lines Removed** .

Bringing More Components into the Assembly

Another way to add components to the assembly is to drag them in from Windows Explorer.

- 1 Start Windows Explorer (if it is not already running).
- 2 Navigate to the `\installation directory\samples\tutorial\universal_joint` folder.
- 3 Click each of the items listed below individually, and drag it into the graphics area of **Assem1**. Place them approximately as shown.

- **yoke_male.sldprt**
- **yoke_female.sldprt**
- **spider.sldprt**

- 4 Examine the FeatureManager design tree, and expand each item to see the features used to make the components.

Notice that each of the new components has the prefix **(-)** before its name, indicating that its location is under defined. You can move and rotate these components.

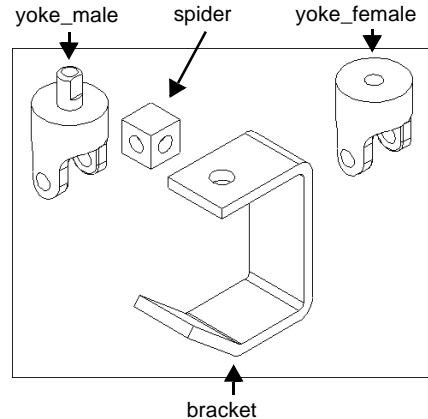

- 5 To collapse the entire FeatureManager design tree in one step, right-click **Assem1** in the FeatureManager design tree and select **Collapse Items**.
- 6 Practice moving and rotating the individual components using the following tools on the Assembly toolbar:



Click **Move Component**, click one of the component's faces, then move the component.



Click **Rotate Component**, click one of the component's faces, then rotate the component.

Both the **Move Component** and **Rotate Component** tools remain active so that you can move other non-fixed components in succession.

- 7 Save the assembly as **U-joint.sldasm**.

Mating the Bracket with the Male Yoke

The following pages describe how to add various types of assembly mating relations.

First, mate the bracket and the male yoke.

- 1 Click **Mate**  or **Insert, Mate**.

The **Mate** PropertyManager appears.

- 2 Click the cylindrical face of the boss on the male yoke and the cylindrical inside face of the top hole in the bracket.

NOTE: You can also select the items to mate before opening the **Mate** PropertyManager. Hold down **Ctrl** as you select the items.

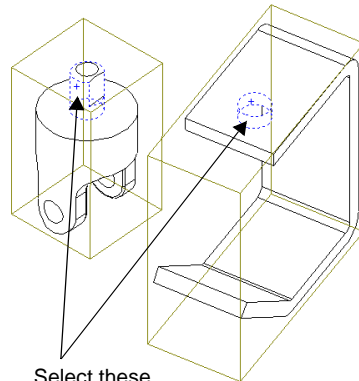

Select these faces

- 3 Click **Concentric** , click **Preview** to check the mate, and click **OK** .

The boss of the male yoke and the bracket hole are now concentrically mated.

- 4 To test the mate, click **Move Component** , and drag the male yoke. You can only drag up and down, following the axis of the concentric mate. (The yoke may spin as it moves.)

- 5 Click **Mate**  or **Insert, Mate** again.

- 6 Click **Keep Visible**  in the **Mate** PropertyManager.

The **Mate** PropertyManager stays open as you continue to add mates.

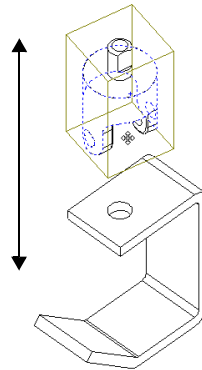

- Click the top inside face of the bracket and the top face of the male yoke.

TIP: To select the top inside face of the bracket without rotating the bracket, right-click the top of the bracket, and click **Select Other**. Click **N** until the correct face is highlighted, then click **Y**.

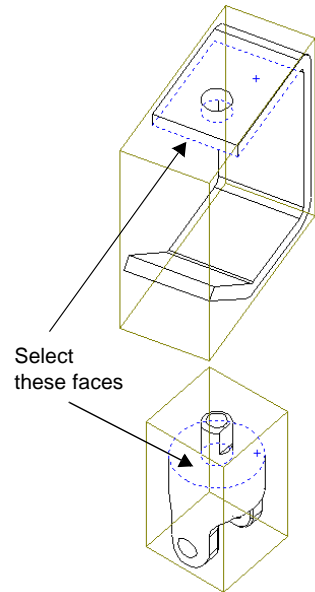

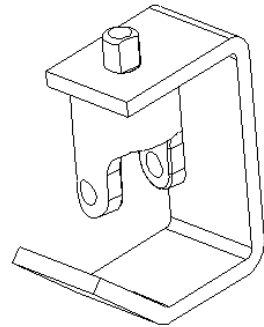

- Click **Coincident**  in the **Mate** PropertyManager, click **Preview**, and click **OK** .

The top of the yoke is now inserted into the bracket hole.





Mating the Male Yoke with the Spider

- 1 Select the inside faces of one pin hole on the male yoke and one spider pin hole.
- 2 Click **Concentric** , click **Preview**, and click **OK** .

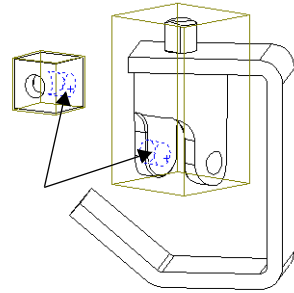
The spider and the male yoke are now concentrically mated.



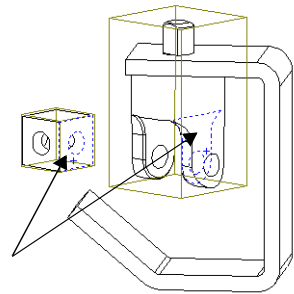

- 3 Select the flat spider face that contains the hole you selected in Step 1 and the inside face of the male yoke. Use **Select Other** or rotate the assembly if necessary.

NOTE: To move and rotate components while the **Mate** PropertyManager is open, use the **Pan**  and **Rotate View**  tools on the View toolbar. To exit from move or rotate mode, click the tool again or press **Esc** so you do not clear the **Selected Items** list.





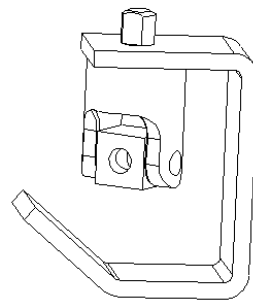

- 4 Click **Coincident** , then click **Preview**.

The spider should be placed inside the male yoke as shown.

- If the mate looks correct, click **OK** .
 - If the mate looks wrong, click **Undo**, select the correct faces, and click **OK** .
- 5 Click **Cancel**  to close the **Mate** PropertyManager.





Mating the Female Yoke and the Spider

- 1 Using the tools on the Assembly toolbar (see page 11-5), move and rotate the female yoke to approximately the position shown here.
- 2 Click **Mate**  or **Insert, Mate**, then click **Keep Visible**  in the **Mate** PropertyManager.
- 3 Select the inside face of the pin hole of the female yoke and one of the visible spider pin holes.
- 4 Click **Concentric** , click **Preview**, and click **OK** .

The spider and the female yoke are concentrically mated.

- 5 Select the flat spider face that contains the hole you used in Step 3, and the inside face of the female yoke.

- 6 Click **Coincident** , click **Preview**, and click **OK** .

The female yoke should be positioned as shown. The rotation may be different in your assembly because it is based on the initial position of the two components before mating.

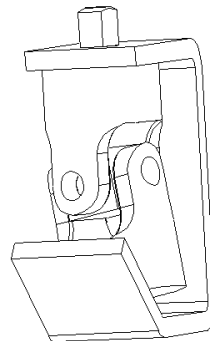
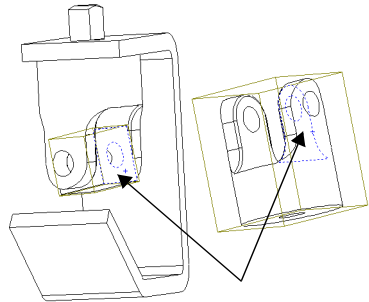
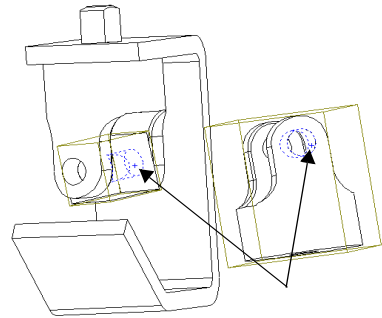

Mating the Female Yoke with the Bottom of the Bracket

- 1 Select the bottom face of the female yoke and the top slanted face of the bracket.
- 2 Click **Parallel** , and click **Preview**.

The female yoke is aligned to the bracket.

- 3 If the female yoke is upside down, change the **Mate Alignment**, and click **Preview** again.

- **Aligned** means that the normal vectors for the selected faces point in the *same* direction.
- **Anti-Aligned (On)** means that the normal vectors for the selected faces point in *opposite* directions.
- **Closest** means that the selected faces may be either aligned or anti-aligned, depending on the positions they occupy when selected.

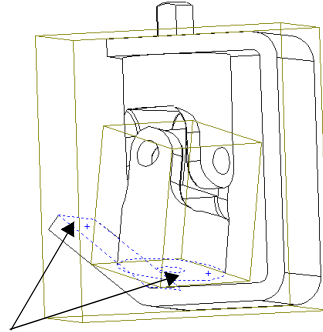

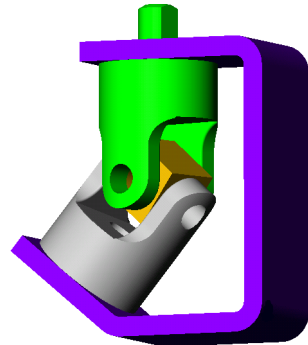

- 4 Click **OK** , then close the **Mate PropertyManager**.
- 5 Save the assembly.



Mating the Small Pins to the Female Yoke

Another way to add components to an assembly is to use the **Insert** menu.

- 1 Click **Insert, Component, From File**, then navigate to *installation directory*\samples\tutorial\universal_joint.
- 2 Select **u-joint_pin2.sldprt**, then click **Open**.
- 3 Click the  pointer in the graphics area where you want to place the component. The **u-joint_pin2<1>** component is added to the assembly.
- 4 Click **Mate**  or **Insert, Mate**, then click **Keep Visible**  in the **Mate PropertyManager**.
- 5 Select the cylindrical face of the pin and an inside face of a pin hole on the female yoke.
- 6 Add a **Concentric** mate.

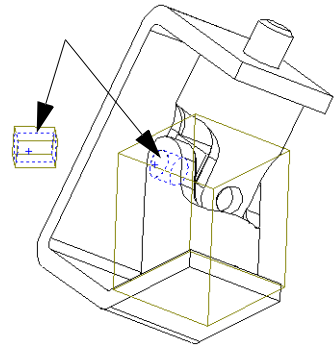

- 7 Select the end face of the pin and the outside face of the female yoke.
- 8 Click **Tangent**  and click **Preview**. If the alignment is incorrect, change the **Mate Alignment** and click **Preview** again.

You use **Tangent** (instead of **Coincident**) for this mate because one face is flat and the other face is cylindrical.

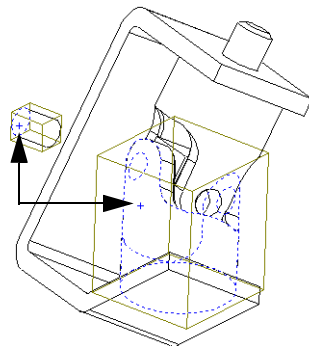

- 9 Click **OK** , then close the **Mate PropertyManager**.
- 10 Hold down **Ctrl**, then drag the **u-joint_pin2<1>** icon from the **FeatureManager** design tree into the graphics area.



A copy of the component is added to the assembly, **u-joint_pin2<2>**. The **<2>** notation indicates the *second instance* of this part in the assembly.

- 11 Repeat Steps 4 through 9 to mate the second instance of the pin to the other hole in the female yoke.
- 12 Save the assembly.

Using SmartMates to Mate the Large Pin

For some mates, you can create mating relationships automatically using SmartMates. You can infer the geometry of existing components as you drag and drop new components into the assembly.

In this section, you create a concentric mate automatically. For more information about SmartMates, see the *SolidWorks 2001 Online User's Guide*.

- 1 Click **File, Open**, and open **u-joint_pin1.sldprt**.
- 2 Tile the windows so that you can see the part and the assembly windows.
- 3 Change the view orientation of the part to **Isometric** , if necessary.
- 4 Change the view mode in the assembly window to **Shaded** , and change the view orientation to **Isometric** . Zoom in on the pin hole in the male yoke.

Shaded mode allows you to see the preview of SmartMates better.

- 5 Select the cylindrical face of the pin, and drag the pin into the assembly. Point at an inside face of the pin hole on the male yoke in the assembly window. (The pin may disappear behind the assembly.)

When the pointer is over the pin hole, the pointer changes to . This pointer indicates that a concentric mate will result if the pin is dropped at this location. A preview of the pin snaps into place.

If the preview indicates that you need to flip the alignment condition, press the **Tab** key to toggle the alignment (aligned/anti-aligned).

- 6 Drop the pin.
A concentric mate is added automatically.
- 7 Close the **u-joint_pin1.sldprt** window, and maximize the assembly window.

Preview of pin

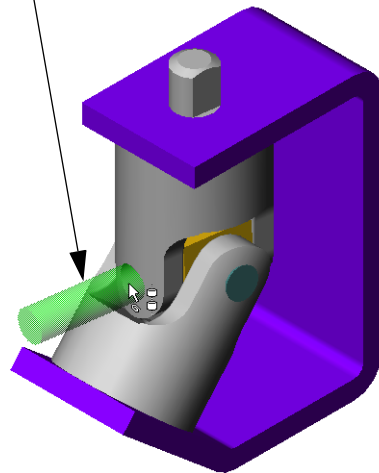

- 8 Click **Mate**  or **Insert, Mate**, then select the end face of the pin and the outside face of the male yoke as shown.



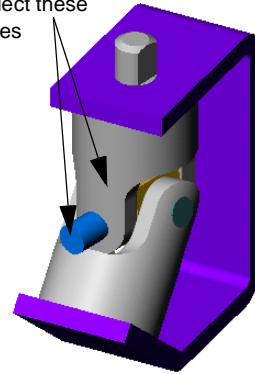



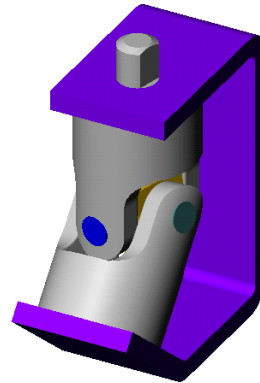

Select these faces



- 9 Add a **Tangent** mate.
- 10 Save the assembly.



Mating the Handle to the Assembly

- 1 Click **Hidden Lines Removed** .
- 2 Drag **crank-assy.sldasm** from Windows Explorer and drop it into the assembly window.
- 3 Click **Mate**  or **Insert, Mate**.
- 4 Select the outside face of the crankshaft and the *cylindrical* face of the male yoke boss (*not* the flat face on the boss).
- 5 Add a **Concentric** mate and click **OK** .
- 6 Click **Move Component** , and drag the crankshaft above the male yoke boss.
- 7 Click **Mate**  or **Insert, Mate**, and click **Keep Visible**  in the **Mate PropertyManager**.
- 8 Click **Hidden In Gray** , then click **Zoom to Area**  and zoom in on the crankshaft and male yoke boss.

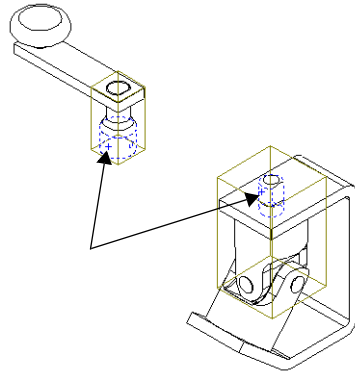

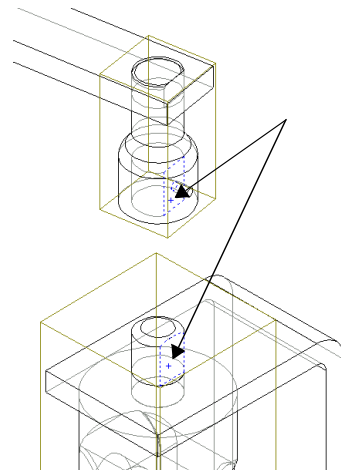

- 9 Select the *flat* face of the male yoke boss and the flat face on the inside of the crankshaft. Use **Select Other** to more easily select any hidden faces.
- 10 Add a **Parallel** mate.

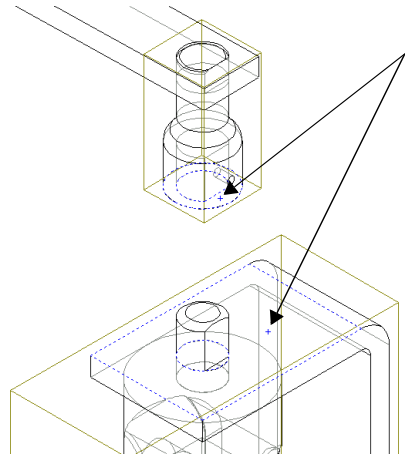

- 11 Select the bottom face of the crankshaft and the top face of the bracket. Add a **Coincident** mate.
- 12 Close the **Mate** PropertyManager, and save the assembly.



- 13 Click **Isometric** , then click **Shaded** .

The completed assembly should appear as shown.

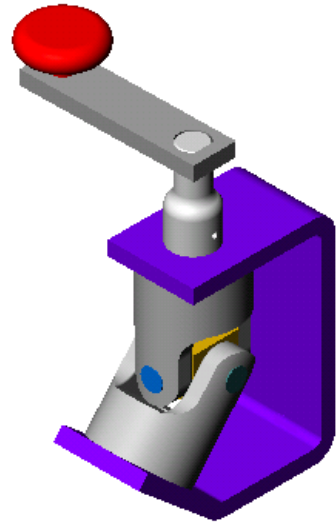

- Click the **+** beside **MateGroup1** of the assembly (not the **crank-assy** sub-assembly) to see the mates.

NOTE: If you have added or deleted mates, the names of the mates in your assembly may differ from those shown here.

Each mate is identified by the type and a number, and the names of the components involved are shown.

As you pause over each mate, the entities involved are highlighted in the graphics area.

You can rename the mates in the same way that you rename the features of a part, if desired.



Rotating the Crank Handle

You can turn the crank of the assembly by selecting the sub-assembly, and moving the handle.

- Click **Move Component** .
- Click a face on one of the components of the crank sub-assembly.
- Drag the pointer vertically in the graphics area.

The crank turns and rotates the male and female yokes. All of the mating relationships are maintained.

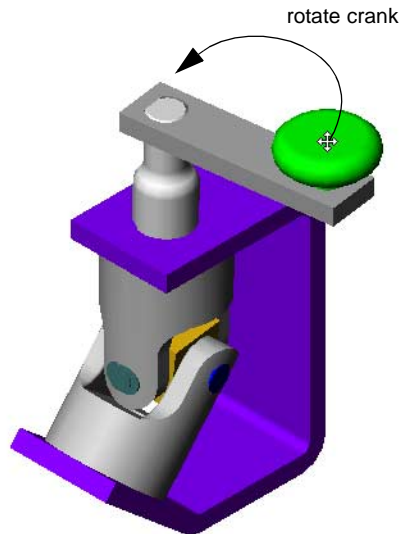

Exploding the Assembly

You can create an exploded view of the assembly. An *exploded view* consists of one or more *explode steps*. In this section, you define the first step in an exploded view.

1 Click **Insert, Exploded View**.

2 In the **Assembly Exploder** dialog box, in the **Step editing tools** box, click **New** .

The **Assembly Exploder** dialog box expands.

3 Click a vertical edge on the bracket to set the **Direction to explode along**.

If the preview arrow is pointing down, select the **Reverse direction** check box.

4 Click a face of a component of the crank assembly in the graphics area, or click the **crank-assy** component in the FeatureManager design tree for the **Components to explode** box.

5 Examine the contents of the boxes under **Step parameters**. Make sure that the **Entire sub-assembly** option is selected. If you need to make any other changes:

- Select and delete the contents of the **Components to explode** box.
- or –
- Click the **Components to explode** box, right-click in the graphics area, select **Clear Selections**, and select again.

6 Click **Apply** .

Notice the arrow-shaped handle in the graphics area.

7 Drag the green handle up and down until the crank assembly is positioned at a reasonable distance from the bracket. (You can specify the position by using the **Distance** box if you prefer.)

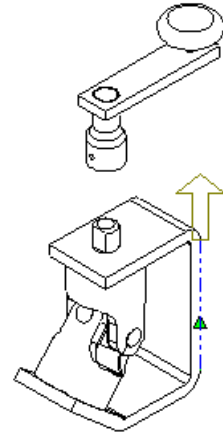

8 Click **Apply**  again to confirm the new distance value in the step.

Do *not* click **OK** yet. Leave the **Assembly Exploder** dialog box open, so you can continue adding steps to the exploded view. You click **OK** only when all the steps in the view are completed.



Adding Explode Steps





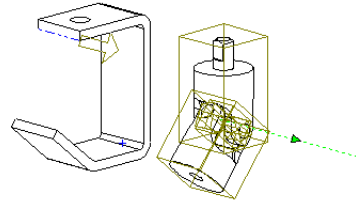
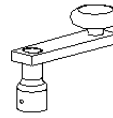

Now add explode steps for other components.

- 1 Click **New**  to create the next explode step.
- 2 Click a horizontal edge on the bracket.
- 3 Click the male yoke, the female yoke, the spider and the pins (either in the graphics area or the FeatureManager design tree).
- 4 Verify the **Step parameters**, and click **Apply** .
- 5 Adjust the distance as desired.
- 6 Click **Apply** .
- 7 Click **OK** to save the exploded view with its two steps.
- 8 Click a blank area in the graphics area to deselect all the selected items.
- 9 To collapse the assembly, restoring it to its previous condition, right-click anywhere in the graphics area and select **Collapse**.



Editing the Exploded View

You can edit the explode steps, or add new ones if needed. You access the exploded view from the ConfigurationManager tree.

- 1 Click the ConfigurationManager tab  to change to the configuration view.
- 2 Double-click **Default**, or click the  to expand the view.
If you are asked to confirm showing the configuration, click **OK**.
- 3 Double-click **ExpView1** to explode the assembly again (or right-click **ExpView1**, and select **Explode**).
- 4 Right-click **ExpView1**, and select **Edit Definition**.
- 5 Using the **Previous Step** and **Next Step** buttons , or the **Explode steps** list, review each of the steps in the exploded view. Edit any step as desired, then click **Apply**  before editing or adding another step.
- 6 Click **New**  to create a new explode step, then practice exploding more of the assembly. Remember to click **Apply**  each time you complete a step.
- 7 When you are satisfied with the entire exploded view, click **OK**.
- 8 To collapse the entire assembly, right-click the assembly name at the top of the ConfigurationManager tree, and select **Collapse**.
- 9 Save the assembly. You will use this assembly later in Chapter 14, “Bill of Materials.”

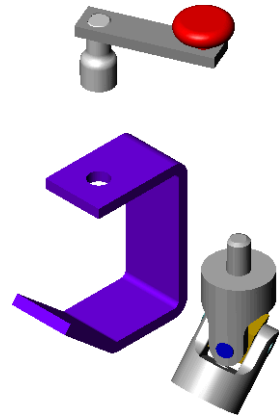

Advanced Design Techniques

Suppose that you want to design a hinge assembly that you can modify easily to make similar assemblies. You need an efficient way to create two matching hinge pieces and a pin for a variety of hinge assembly sizes.

Some analysis and planning can help you develop a design that is flexible, efficient, and well defined. You can then adjust the size as needed, and the hinge assembly will still satisfy the design intent.

This chapter discusses:

- ❑ Analyzing the assembly to determine the best approach
- ❑ Using a *layout sketch*
- ❑ Suppressing features to create *part configurations*
- ❑ Creating a new part *in the context* of the assembly

This chapter assumes that you know how to perform basic assembly operations, such as moving and rotating components, and adding mates. (These topics are covered in Chapters 3 and 11 of this guide.)

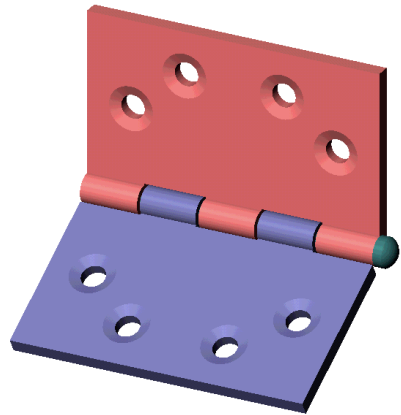

Analyzing the Assembly

Successful customers tell us that the key to using the SolidWorks software effectively is planning. By performing a careful analysis, you can design better, more flexible, functional models. Before you begin, analyze the assembly with the following considerations in mind:

- ❑ Consider dependencies between the components of an assembly. This will help you decide on the best approach:
 - Using *bottom-up* design, you build the parts independently, then insert them into the assembly.
 - Using *top-down* design, you may begin with some ready-made parts. Then you create other components *in the context of the assembly*. You reference the features of some components of the assembly to drive the dimensions of the other components.
- ❑ Identify the features that make up each individual part. Understand the dependencies between the features of each part. Look for patterns, and take advantage of symmetry whenever possible.
- ❑ Consider the order in which the features are created, and keep in mind the manufacturing processes that will be used to make the parts.

Dependencies in the Assembly

The hinge pieces

The two pieces of the hinge are alike: the size and thickness of the body, the barrel that receives the pin, and the placement of the screw holes. The only differences between the two pieces are the cuts and tabs on the barrel, where they fit together.

There are several ways to approach this task:

- ❑ **Copy.** You could make one piece, make a *copy* of it, then modify the copy as needed for the second piece. However, if you wanted to make another assembly in a different size, you would need to edit both pieces. This is not the best approach; it leaves room for error because the pieces are independent of each other.
- ❑ **Derive.** You could create a base part consisting of only the common elements, then *derive* the two pieces from it (using **Insert, Base Part** or **Insert, Mirror Part**). To make changes to the common dimensions, you edit the original, and the derived parts are updated automatically. This behavior is useful in some circumstances, but it has drawbacks for this application. You do not have access to the driving dimensions of the original part when editing a derived part, so you cannot reference those dimensions when creating the features that differ.

- ❑ **Configure.** The method that you use for this example is to make two different *configurations* of the same part. This is the best way to ensure that you always have matching pieces, because a single part document is used to create the two pieces. The part document contains all the possible features to be used. Then you create configurations by *suppressing* selected features, removing them from the active configuration.

The pin

You need to know the dimensions of the barrel to create a pin that is exactly the right size for the assembly. By creating the pin *in the context of the assembly*, you can accomplish this for any size hinge.

Conclusion

For this assembly, it makes sense to use a combination of design methodologies. First, design the hinge pieces, including the necessary configurations, and insert them in an assembly (bottom-up design). Then design the pin in the context of the assembly (top-down design), referencing the model geometry of the hinge pieces as necessary.

Analysis of the Individual Parts

Now that you understand the dependencies between components, take a look at the parts individually.

The common features of the hinge pieces

The base feature is a flat rectangle, with a round barrel along one edge. The diameter of the barrel is dependent on the thickness of the base. Each piece has four countersunk holes. The position of the holes is symmetric with respect to the midpoint of the long edge. As the size of the hinge changes, you want the holes to remain properly spaced along the length and width.

The different features of the hinge pieces

The cuts (and corresponding tabs) along the barrel are the features that distinguish the two pieces. One piece has three cuts, and the other has two cuts. The placement is symmetric with respect to the midpoint of the long edge. Each cut should be slightly larger than the corresponding tab, so the hinge will not bind when assembled.

The pin

The pin is dependent on the hinge pieces for its length and diameter dimensions. The domed head of the pin should match the outer diameter of the barrel.

Feature Order

Now, outline the features you will use and decide on the order to create them.











- 1 *Base feature* – extrude as a thin feature. Because the part has symmetric features, use a mid-plane extrusion. Then you can use the mid-plane as a plane of symmetry for mirroring other features.
- 2 *Barrel* – sweep a circular profile along the long model edge. Then extrude a cut, concentric with the boss.
- 3 *Countersunk holes* – use the **Hole Wizard** to create a complex hole profile, then use equations and mirroring to position several copies.
- 4 *Cuts for tabs* – create a layout sketch, referencing the dimensions of the base. Use the sketch to extrude two different cut features, one with three tabs, one with two tabs.
- 5 *Configurations* – define the two configurations used in the assembly by *suppressing* one cut feature in each configuration.
- 6 *Assembly* – insert and mate the hinge pieces (one of each configuration).
- 7 *Pin* – insert a new part while in the assembly. Reference the geometry of the hinge piece to sketch a profile and a path. Then use a sweep to create the base feature.
- 8 *Pin head* – convert the barrel profile to create a sketch, then extrude it. Finally, add a dome to the flat surface of the head.

A Final Word

This may seem like a great deal of planning to develop a simple assembly. However, it is a worthwhile exercise if it helps you discover the best approach to building the parts *before* you start designing them. By thoroughly analyzing the issues before you begin, you can create a flexible, fully parametric model. When you change any of its parameters, the others update accordingly.

For more examples that showcase design intent and implementation, view the *SolidWorks Design Portfolio* by clicking **Help, Design Portfolio**.

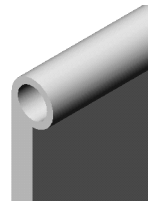
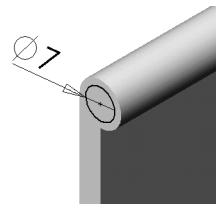
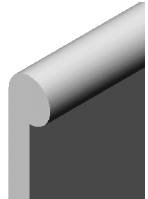
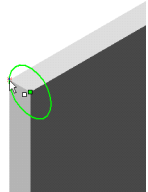

Creating the Basic Hinge Piece

- 1 Open a new part from the **Tutorial** tab and open a sketch on the **Front** plane.
- 2 Sketch a vertical line and dimension it to 60mm in length.
- 3 Click **Extruded Boss/Base**  or **Insert, Base, Extrude** to extrude the sketch:
 - a) Under **Direction 1**, do the following:
 - Set **End Condition** to **Mid Plane**.
 - Set **Depth**  to 120mm.
 - b) Under **Thin Feature**, do the following:
 - Leave **Type** as **One-Direction**.
 - Set **Direction 1 Thickness**  to 5mm.
 - c) Click **OK** .
- 4 Open a sketch on the narrow vertical face. Sketch a circle at the upper edge, with its center at the front vertex.
- 5 Add a coincident relation between the edge of the circle and the back vertex to fully define the sketch. Close the sketch.
- 6 Click **Sweep**  or **Insert, Boss, Sweep**. Select the circle as the **Profile** . Select the **Path**  box in the **Boss-Sweep** PropertyManager and click one of the long model edges. Click **OK** .
- 7 Cut a hole through the barrel:
 - a) Open a sketch on the narrow face.
 - b) Sketch and dimension a small circle as shown, and add a concentric relation to the outside edge of the barrel.
 - c) Click **Extruded Cut**  or **Insert, Cut, Extrude**. Set **End Condition** to **Through All**, and click **OK** .
- 8 Save the part as **Hinge.sldprt**.



Adding the Screw Holes

In this section, you add holes for screws. To position each hole, one dimension is fixed, and the other is driven by an equation.

- 1 Click the large model face, then click **Hole Wizard**  on the Features toolbar, or click **Insert, Features, Hole, Wizard**.
- 2 On the **Countersink** tab of the **Hole Definition** dialog box, set the following values:
 - **Standard** to **Ansi Metric**.
 - **End Condition & Depth** to **Through All**.
 - **Hole Fit & Diameter** to **Normal** and 8mm.
 - **C'Sink Diameter & Angle** to 15mm and 82°.
- 3 Click **Next**, then click on the large model face to add the center point for a second hole.
- 4 Click **Select**  and drag the points to the approximate location on the face shown here. Click **Finish**.

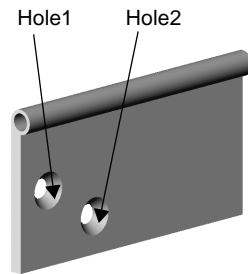

- 5 Right-click the under defined sketch containing the points for **Hole1**, and select **Edit Sketch**. Dimension the points to the edges of the hinge as shown. Do not close the sketch.
- 6 Add an equation to control the location of one of the points:

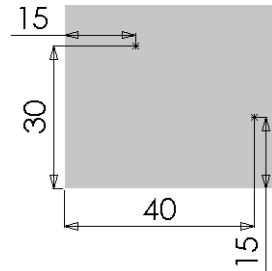

- a) Click **Equations**  on the Tools toolbar or **Tools, Equations**, then click **Add**.
- b) Clear the default text in the **New Equation** dialog box, if necessary.
- c) Select the 30mm dimension, then type **=**.
- d) Double-click the base to expose its dimensions then select the 60mm dimension.
- e) Type **/2** to complete the dimension and click **OK** to close the **New Equation** dialog box.

This sets the distance between the point and the *bottom* edge to one-half the height (60mm) of the hinge.

- 7 Add an equation to control the location of the other point:
 - a) Click **Add** in the **Equations** dialog box.
 - b) Clear the default text in the **New Equation** dialog box, if necessary.
 - c) Select the 40mm dimension then type $=$.
 - d) Double-click the base to expose its dimensions then select the 120mm dimension.
 - e) Type $/3$ to complete the dimension and click **OK** to close the **New Equation** dialog box.

The distance between the point and the *side* edge equals one-third of the length (120mm) of the hinge.

- 8 Click **OK** to close the **Equations** dialog box, then close the sketch.
- 9 Mirror the holes:

- a) Click **Mirror Feature**  on the Features toolbar, or click **Insert, Pattern/Mirror, Mirror Feature**.
- b) Click the **Front** plane in the FeatureManager design tree.

Front appears in the **Mirror plane** box.

- c) Click the hole feature in either the FeatureManager design tree or in the graphics area.

Hole1 appears in the **Features to mirror** box.

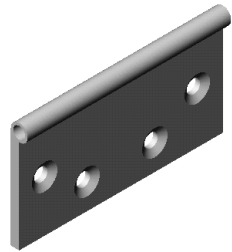

- d) Click **OK**.

- 10 Save the part.



Creating a Layout Sketch for the Cuts

The layout sketch you create in this section divides the length of the hinge into five equal parts. Using equations and mirroring ensures that the five parts remain equal when you change the overall length of the hinge. You use this layout as a guide for making the cuts in the sections that follow.

- 1 Open a sketch on the large model face, and name it **layout for cuts**.
- 2 Click the lower edge of the sweep feature and click **Offset Entities** .
 - a) Set **Offset Distance** to 1mm.
 - b) Select the **Reverse** check box if necessary to offset *below* the selected edge
 - c) Click to clear the **Select chain** check box.
 - d) Click **OK** .

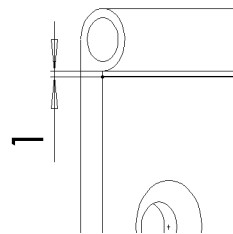

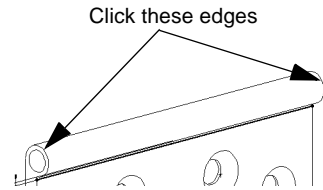

- 3 Select the edges shown, then click **Convert Entities** .

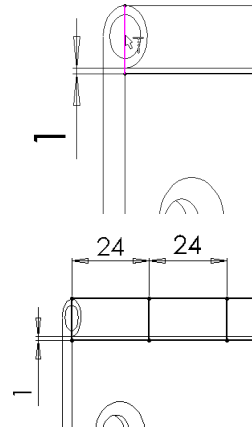

- 4 Click **Extend**  in the Sketch Tools toolbar, or click **Tools, Sketch Tools, Extend**, then click the converted edges. Each vertical line is extended to meet the nearest sketch entity, in this case, the offset horizontal line.
- 5 Sketch a horizontal line to connect the two converted edges across the top.
- 6 Sketch two vertical lines as shown, and dimension them. As you sketch the lines, be sure that you do not inference the geometry of the holes. Also, because the dimensions will be driven by an equation, the values of the dimensions do not matter at this time.



- 7 Add the equations:

- a) Click the FeatureManager tab , right-click the **Equations** folder , and select **Add Equation**.
- b) Add equations that set each dimension to one-fifth of the dimension of the overall length.

$$\text{"D2@layout for cuts"} = \text{"D1@Base-Extrude-Thin"} / 5$$

$$\text{"D3@layout for cuts"} = \text{"D1@Base-Extrude-Thin"} / 5$$

- c) Click **OK** to close the **Equations** dialog box.

- 8 Sketch a vertical centerline across the midpoint of the part. Select the two vertical lines and the centerline, and click **Mirror** .



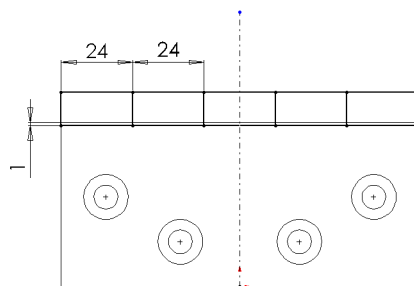

The sketch is complete and should be fully defined.

- 9 Close the sketch.
- 10 Save the part.





Cutting the Hinge (3Cuts)

Now you can reference the **layout for cuts** sketch to create the first set of cuts. Because each cut should be slightly wider than the corresponding tab on the other half of the hinge, you use offsets from the layout sketch entities.

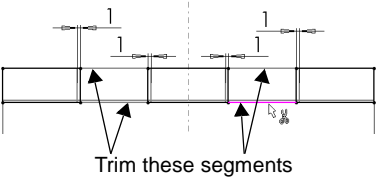
- 1 Open a sketch on the large model face.
- 2 Click the bottom line in the layout sketch, and click **Convert Entities** . In the **Resolve Ambiguity** box, click **closed contour**, and click **OK**. This copies the entire outside contour into the current sketch.
- 3 Click one of the vertical lines near the edge of the part, click **Offset Entities**  and do the following:
 - a) Set **Offset Distance** to 1mm.
 - b) Select the **Reverse** check box if necessary to offset the line towards the *middle* of the part.
 - c) Make sure that **Select chain** is *not* selected, and click **OK** .
- 4 Repeat for the vertical line near the opposite edge of the part.
- 5 Click one of the vertical lines near the center of the part, and offset the line by 1mm toward the *outside* of the part (making the center cut wider). Repeat for the remaining vertical line.
- 6 Click **Trim** , then trim the horizontal lines as indicated, leaving three closed rectangles.



Trim these segments
- 7 Click **Extruded Cut**  or **Insert, Cut, Extrude**. Select **Through All** as **End Condition** for *both* **Direction 1** and **Direction 2**.
- 8 Click **OK** .
- 9 Rename the cut feature **3Cuts**.
- 10 Save the part.

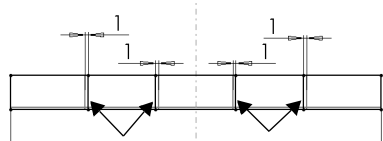
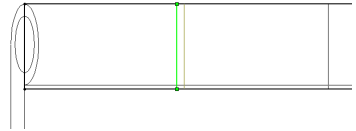

Segments in current sketch

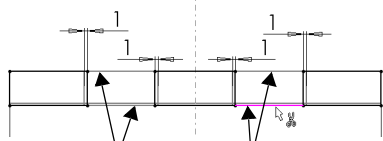

Trim these segments

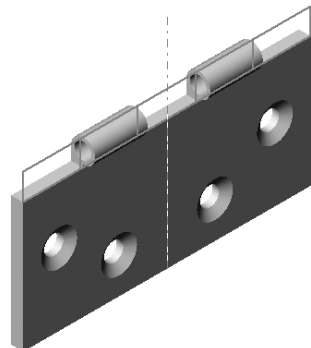



Cutting the Hinge (2Cuts)

Now you use the same methods to create the cuts for the other half of the hinge.

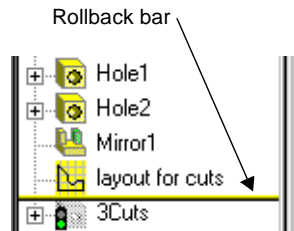
- 1 Roll back the design to the **3Cuts** feature by dragging the rollback bar to just below the **layout for cuts** sketch.
- 2 Repeat Steps 1 and 2 from the previous section.



- 3 Click one of the vertical lines near the edge of the part, click **Offset Entities** , and do the following:
 - a) Set the **Offset Distance** to 1mm.
 - b) Offset it towards the *outside* of the part.
 - c) Make sure that **Select chain** is not selected. and click **OK** 

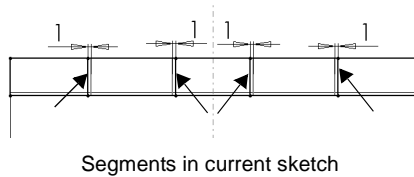

- 4 Repeat for the vertical line near the opposite edge of the part.
- 5 Click one of the vertical lines near the center of the part, and offset it by 1mm toward the *middle* of the part. Repeat for the remaining vertical line.

- 6 Click **Trim** . Trim the three segments at each end and the two segments in the middle, leaving two closed rectangles.
- 7 Extrude the cut as described in the previous section.

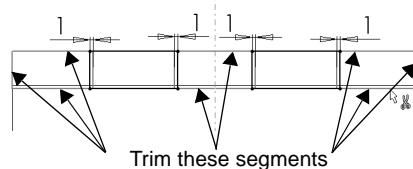

- 8 Rename this cut feature **2Cuts**.
- 9 Right-click the **layout for cuts** sketch, and select **Hide**.

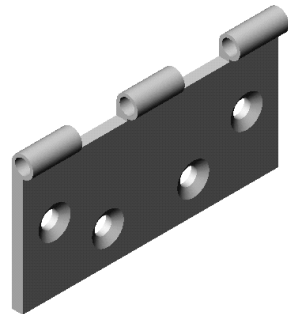



Creating the Part Configurations

Roll the design forward by dragging the rollback bar all the way to the bottom of the FeatureManager design tree.



The part now has the entire barrel removed by the two cut features. This is the default configuration, which includes all the features. In this section, you make two more configurations of the part by suppressing selected features.

The OuterCuts configuration

- 1 Click the ConfigurationManager tab  at the bottom of the window to change to the ConfigurationManager view.
- 2 Right-click the part name at the top of the ConfigurationManager tree, and select **Add Configuration**.
- 3 Enter a **Configuration Name**, such as **OuterCuts**, in the box and click **OK**.
- 4 Click the FeatureManager tab at the bottom of the window to switch back to the FeatureManager view. Notice the configuration name beside the part name at the top of the tree: **Hinge (OuterCuts)**.
- 5 Click the **2Cuts** feature, then click **Suppress**  on the Features toolbar, or click **Edit, Suppress**.

The **2Cuts** feature is unavailable in the FeatureManager design tree, and is inactive in the current configuration.

The InnerCuts configuration

- 1 Repeat Steps 1 and 2 from the previous section.
- 2 Enter a **Configuration Name**, such as **InnerCuts**, in the box, then click **OK**.
- 3 Switch back to the FeatureManager view. Notice the configuration name: **Hinge (InnerCuts)**.
- 4 Click the **3Cuts** feature, then click **Suppress** . (Now both cuts are suppressed.)
- 5 Click the **2Cuts** feature, then click **Unsuppress**  on the Features toolbar, or click **Edit, Unsuppress**.



The **3Cuts** feature is unavailable in the FeatureManager design tree, and the **2Cuts** feature is active in the current configuration.

- 6 Save the part.

Inserting and Mating the Parts in an Assembly

Now you can begin creating the assembly.

- 1 Open a new assembly from the **Tutorial** tab and click **View, Origins** to show the origins.
- 2 Tile the windows, and drag the **Hinge** from the top of the FeatureManager design tree of the open part window into the assembly window. Inference the assembly origin while you place the component to align the planes of the assembly and the component.
- 3 Maximize the assembly window.
- 4 Right-click the component, and select **Component Properties**. Under **Referenced configuration**, notice that **Use named configuration** and **InnerCuts** are selected by default. **InnerCuts** is the active configuration name of the part added in Step 2. Click **OK** to close the dialog box.
- 5 Hold down **Ctrl**, then drag the **Hinge** from either the graphics area or the FeatureManager design tree, and drop it beside the first one to create another instance.

Use **Move Component**  and **Rotate Component Around Axis**  to turn the second **Hinge** so that it faces the first one.

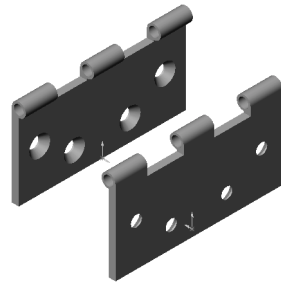

- 6 To change the named configuration, edit the component properties of the second **Hinge**. Click **Use named configuration**, select **OuterCuts** from the list, and click **OK**.
- 7 Create a **Coincident** mate between the narrow front faces of the components. Create a **Concentric** mate between the cylindrical faces of the barrels.

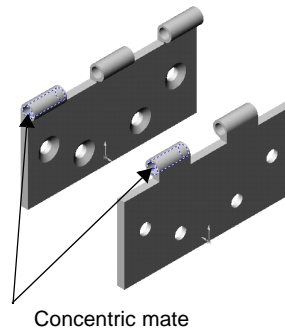
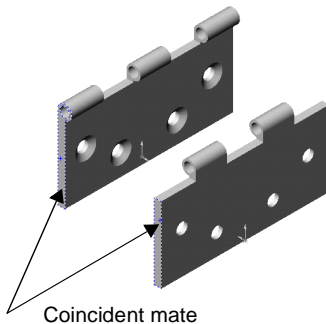

You should be able to open and close the hinge assembly using **Move Component** .

- 8 Save the assembly as **Hinge.sldasm**.

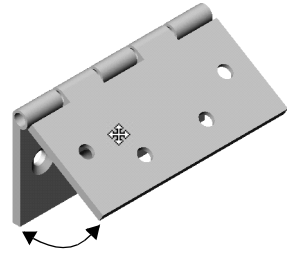

Creating a New Part in the Assembly

Now you add the pin. The pin references the inner diameter of the barrel and the overall length of the hinge pieces. Once you reference an entity of one part (the barrel) to create an entity in another part (the pin), you create a reference in the context of the assembly. If you modify the referenced entity, the new entity updates to reflect that change.

- 1 Click **Insert, Component, New Part**. Select a new part from the **Tutorial** tab. Enter a name for the new component, such as **Pin.sldprt**, and click **Save**.

The pointer changes to .

- 2 Click the narrow model face on the front of the assembly. The new part will be positioned on this face, with its location fully defined by an **InPlace** mate.

A sketch is opened automatically on the selected face. Notice that **Edit Part**  in the Assembly toolbar is selected, and that the pin component is displayed in pink in the FeatureManager design tree.

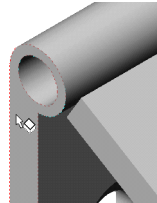



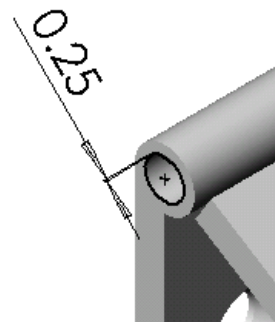

- 3 Click the inner circular edge of the barrel, then offset it to the inside by 0.25mm.
- 4 Exit the sketch.

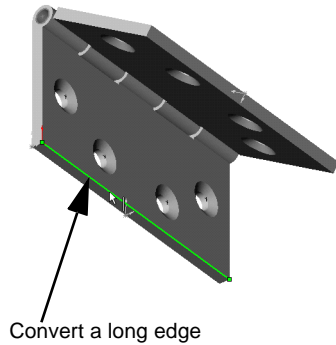

Working with Assemblies

- 5 In the FeatureManager design tree, expand the **pin** component, click the **Right** plane, and open a sketch. Click one of the long edges of the model, then click **Convert Entities** .
- 6 Exit the sketch.



- 7 Click **Sweep**  or **Insert, Base, Sweep**. Use the circle (Sketch1) as the **Profile**  and the line (Sketch2) as the **Path** , and click **OK**  to create the base feature of the pin.

Notice that the part you are editing is pink in the graphics area, and the status bar in the lower-right corner indicates that you are still editing the part.

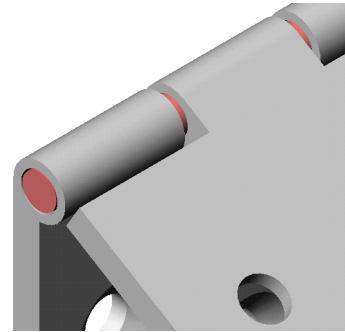



Adding a Head to the Pin

Now reference the barrel of the hinge to create the head of the pin.

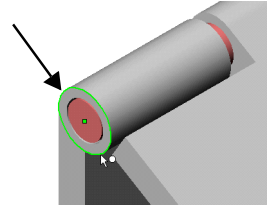
- 1 Open a sketch on the flat end of the pin, and sketch a circle anywhere.
- 2 Select the circle and the outer circular edge of the barrel, and add a **Coradial** relation.



- 3 Click **Extruded Boss/Base** . Set **End Condition** to **Blind**, set **Depth**  to 3mm, and click **OK** .

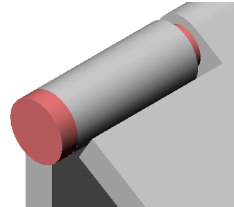

- 4 To add a dome to the head of the pin, click **Dome**  on the Features toolbar, or click **Insert, Features, Dome**.
- 5 Click the flat face of the pin, set **Height** to 3mm. Observe the preview of the dome. Click **OK**. This completes the pin.

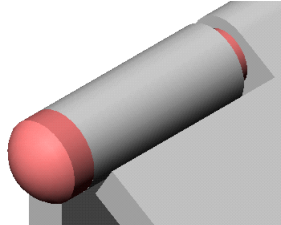
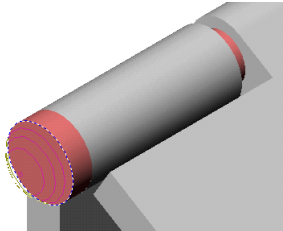

- 6 Right-click in the graphics area, and select **Edit Assembly: Hinge**. Alternatively, you can click **Edit Part**  on the Assembly toolbar to return to editing the assembly.
- 7 Save the assembly.

Changing the Color of a Component

For easier viewing, you can change the color of assembly components.

- 1 Click one of the assembly components in either the FeatureManager design tree or in the graphics area, then click **Edit Color** .
- 2 Choose a color from the palette, then click **OK**.

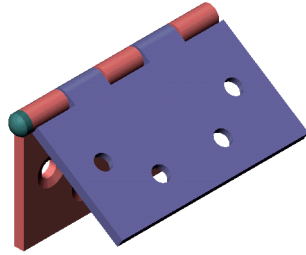



Editing the Hinge Components

Now you can make this same hinge assembly in a different size.

- 1 In the FeatureManager design tree, expand the hinge component that uses the **InnerCuts** configuration. Double-click the **Base-Extrude-Thin** feature to display its dimensions.
- 2 Double-click any of the dimensions. The **Modify** dialog box appears.
- 3 Change the dimension value, and make sure that **All configurations** is selected.
- 4 Click to close the **Modify** dialog box.

If desired, repeat Steps 2 through 4 to change another value.

- 5 Click **Rebuild**  or **Edit, Rebuild**. All of the components in the assembly update automatically. (If you see a message indicating that the pin has rebuild errors, click **Rebuild**  again.)

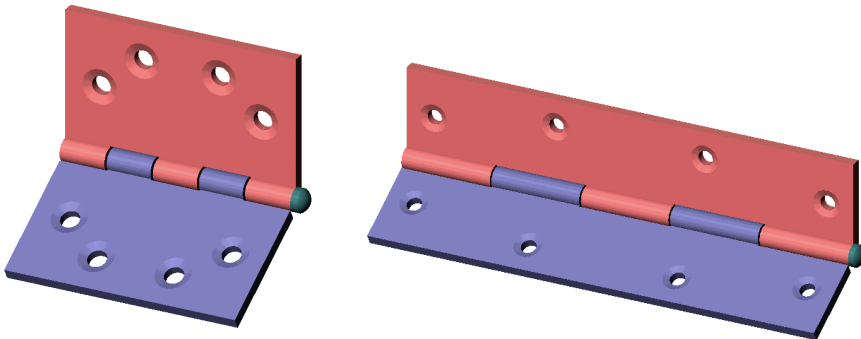

More about Assemblies



You can do much more with assemblies than what is shown in the examples of the *SolidWorks 2001 Getting Started*. The following pages provide a brief introduction to this additional functionality. For more information, see the *SolidWorks 2001 Online User's Guide*.

SmartMates

In addition to the SmartMates you added in Chapter 11, “Assembly Mates,” you can add other types of SmartMates. You can add feature-based mates between conical or cylindrical features. You can add a pattern-based mate to align two components using the circular patterns in the components.

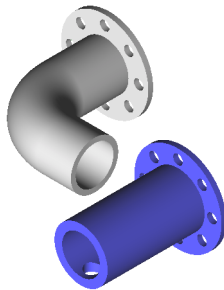

Components to mate

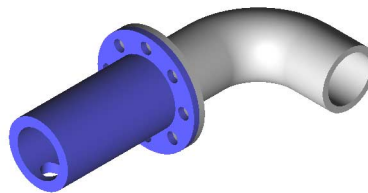

Result of pattern-based mate

Working with Sub-assemblies

- You can form a sub-assembly from components that are already in the assembly.
- You can dissolve a sub-assembly into individual components, thereby moving the components into the parent assembly.
- You can move components into or out of sub-assemblies.

Interference Detection, Collision Detection, and Dynamic Clearance

In a complex assembly, it may be difficult to visually determine whether components interfere with each other. In some cases, it becomes more difficult when you move components in the assembly. You can use the following tools to determine interference:

- ❑ **Interference Detection.** You can determine the interference between components and examine the resulting interference volumes.
- ❑ **Collision Detection.** You can detect collisions with other components when moving or rotating a component.
- ❑ **Dynamic Clearance.** You can dynamically detect the clearance between components when moving or rotating a component. As you move or rotate a component, a dimension appears indicating the minimum distance between the selected components.

Assembly Envelopes

You can select components based on their positions with respect to an assembly envelope. An assembly envelope is a reference component, and it is ignored in global assembly operations (Bill of Materials, Mass Properties, and so on.) You can perform various editing operations (hide, suppress, copy, or delete) on components that are inside, outside, or crossing the assembly envelope.

Component Selection by Properties

You can select components for editing operations based on properties. Once you select those components that match the properties you specify, you can perform the desired editing operation, such as suppress, hide, or copy.

Component Patterns

You can define a pattern for placing components in an assembly in much the same way as you define a feature pattern in a part. You can also place a pattern of components in an assembly based on a feature pattern of an existing component. For example, you can insert a set of screws in a pattern of holes on a part.

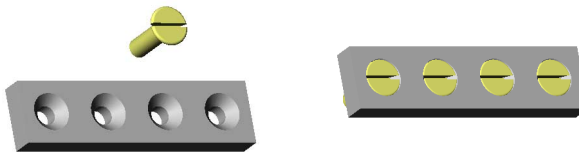

Assembly Features

While in an assembly, you can create cut or hole features that exist *in the assembly only*. You determine which of the assembly components you want the feature to affect. This is useful for creating cuts or holes that are added *after* the components are assembled.

Layout Sketches

You can design an assembly from the top-down using layout sketches. You can construct one or more sketches showing where each assembly component belongs. Then, you can create and modify the design before you create any parts. In addition, you can use the layout sketch to make changes in the assembly at any time.

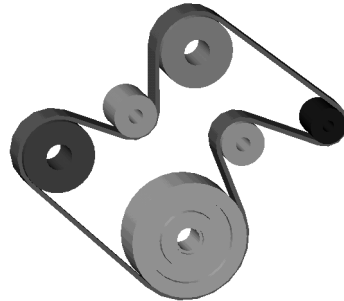
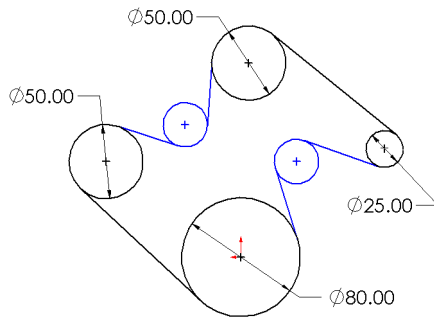

Joining Parts

You can join two or more parts to create a new part. The join operation removes surfaces that intrude into each other's space, and merges the part bodies into a single solid volume.

Weld Beads

You can add a variety of weld types to an assembly. The software prompts you for the weld type, the surface type, and the surfaces you want to weld together. When you create a weld, a weld symbol is automatically attached to the weld bead component in the assembly.

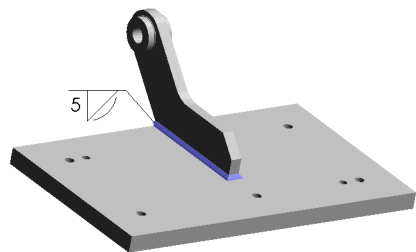



Working with Drawings and Detailing

Advanced Drawings and Detailing

Bill of Materials

More about Drawings and Detailing

ITEM NO.	QTY	PART NO.	DESCRIPTION
1	1	bracket	Bracket
2	1	Yoke_female	Yoke 1
3	1	spider	Spider
4	1	Yoke_male	Yoke 2
5	2	UJoint_pin2	Small Pin
6	1	UJoint_pin1	Large Pin
7	1	crank-assy	Crank Assembly
	1	CRANK-SHAFT	Crank Shaft
	1	CRANK-ARM	Crank Arm
	1	crank-knob	Crank Knob

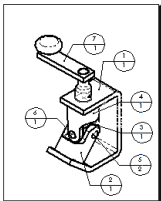

SolidWorks

Advanced Drawings and Detailing

Drawing Basics (Chapter 5) introduced the Standard 3 Views and Named Views. In this chapter, you learn about using SolidWorks software to create the following:

- Section View*
- Detail View*
- Ordinate Dimensions*
- Annotations*
- Exploded View*
- Notes*

Handle Assembly

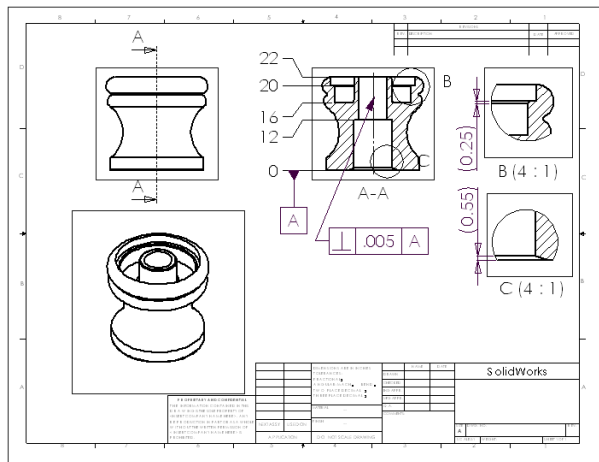
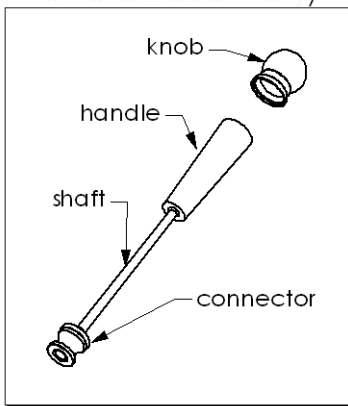

Starting the Drawing with Named Views

Open a drawing and insert a **Named** view.

- 1 Open a new drawing from the **Tutorial** tab.
- 2 Right-click anywhere on the drawing sheet and select **Properties**.
The **Sheet Setup** dialog box appears.
- 3 Change **Scale** to 2:1, then click **OK**.
- 4 Click **Named View**  or **Insert, Drawing View, Named View**.
- 5 Right-click in the graphics area, and select **Insert From File**.
- 6 In the **Insert Component** dialog box, navigate to **connector.sldprt** in directory `\installation directory\samples\tutorial\handle`, and click **Open**.
The **Named View** PropertyManager appears.
- 7 Click to place the view at the upper left of the drawing.
- 8 With the view selected, double-click to choose ***Right** from the **View Orientation** list.

NOTE: You can change the view orientation at any time by selecting the view and choosing a different item from the **View Orientation** list.

- 9 Repeat steps 4 through 6. Place this view at the lower left of the drawing and select ***Isometric** from the **View Orientation** list.

- 10 Click **Save** .

The **Save As** dialog box appears with **connector.slddrw** as the default name.

- 11 Type **Adv-Drawing**, then click **Save**.

If you see a message asking if you want to update any referenced models, click **Yes**.

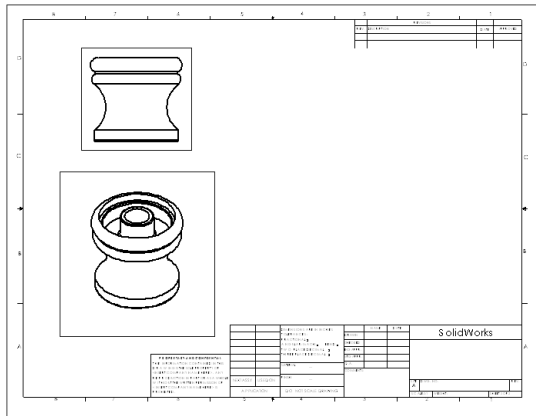

Adding a Section View

You add a **Section View** by cutting a view with a section line.

- 1 Double-click the view at the top left, or right-click the view and select **Activate View**.
- 2 Click **Centerline**  on the Sketch Tools toolbar, or click **Tools, Sketch Entity, Centerline**.

NOTE: You can sketch the section line with either the **Centerline** tool *or* the **Line** tool. If you intend to use the **Line** tool, you can select the **Section View** tool first. The **Line** tool is activated automatically.

- 3 Hold the pointer over the center of the part until the pointer changes to  indicating that the pointer is exactly on the temporary axis. Starting above or below the part, sketch a centerline vertically through the part.

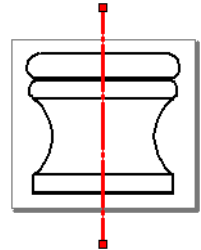



- 4 With the section line still selected, click **Section View**  on the Drawing toolbar, or click **Insert, Drawing View, Section**.

As you move the pointer, a preview of the view position is displayed. By default, the view is aligned in the direction of the cut.

- 5 Click the graphics area to place the view to the right of the original view.

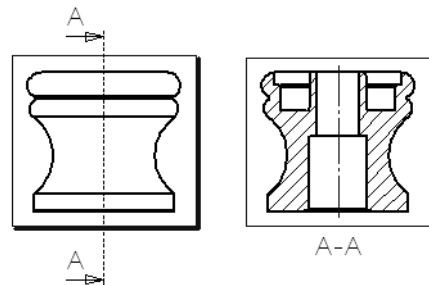
Notice the arrows indicating the direction of the cut. You can double-click the section line, or select the **Change direction** check box in the PropertyManager, to reverse the direction of the arrows, if necessary.



TIP: If you reverse the direction of the section line arrows, the **Section View** is marked with a crosshatch pattern. This crosshatch indicates that the view is out of date. Right-click the view and select **Update View** to update the view only, or click **Rebuild**  to rebuild the entire drawing.

Adding a Detail View

A **Detail View** shows a portion of another view, usually at an enlarged scale.



To set the scale for detail views:

- 1 Click **Tools, Options**. On the **System Options** tab, click **Drawings**.
- 2 Make sure that **Detail view scaling** is 2X, then click **OK**.

The Detail View is scaled relative to the drawing sheet scale, which appears in the lower right corner of the status line. The scale for this drawing sheet is 2:1. Because the Detail View scaling is 2X, the Detail View is drawn at 4:1.

You sketch a *profile* to specify the area to be shown in the Detail View. The profile can be any shape but it is usually a circle.

To create a detail view:

- 1 Double-click the **Section View**, or right-click and select **Activate View**.
- 2 Click **Circle**  or click **Tools, Sketch Entity, Circle**.
- 3 Sketch a circle on the **Section View** at the upper right.
- 4 With the circle still selected, click **Detail View**  on the Drawing toolbar, or click **Insert, Drawing View, Detail**.

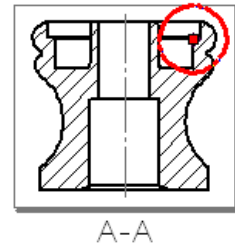

When you move the pointer, a preview of the view is displayed. The detail view is not aligned to any other view. You can move it freely to any location on the drawing sheet.

- 5 Click the graphic area to place the view.

The view letter and scale are displayed.

- 6 Click in the graphic area to close the PropertyManager.
- 7 Repeat steps 1 through 6, sketching a circle at the lower right corner of the connector shaft and placing the view at the lower right.
- 8 Select one of the profile circles in the **Section View**. Increase and decrease the size of the circle by dragging the circumference. Drag the center of the circle to move the circle. Notice that the **Detail View** changes as the circle changes.

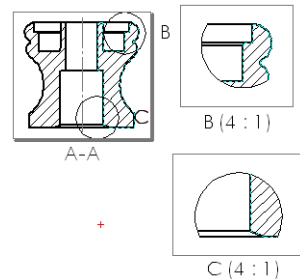

NOTE: The view label letter increments automatically. To set the label letter for the next view, right-click the *graphics area* and select **Properties**. Edit the text in **Next view label**.

To edit the current view label, select the Detail View circle. In the **Detail View** PropertyManager, you can edit the label text, change the text **Font**, select a circle **Style**, choose **View Options**, and set **Custom Scale**.

Inserting Ordinate Dimensions

To insert ordinate dimensions:

- 1 Click **Dimension** , right-click in the graphics area and select **Ordinate Dimension** from the shortcut menu, or click **Tools, Dimensions, Ordinate**.

- 2 In the **Section View**, click the bottom horizontal line.

The first line you click becomes the zero position. Its label is 0. The other dimensions are calculated from this position.

- 3 Click again to place the ordinate.
- 4 Click the other horizontal lines in the view.

The leaders jog automatically to prevent overlapping text. You can drag the dimensions left and right as a group.

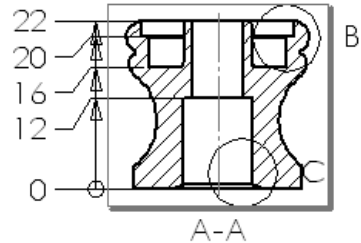

To modify the ordinate dimensions:

- 1 Click **Select** , then right-click the top dimension and select **Display Options, Jog**.

The dimension is selected, and handles appear on the leader.

- 2 Drag the dimension (not the handles) upwards. The dimensions remain aligned vertically.
- 3 Right-click the second dimension (20) and select **Display Options, Jog**.

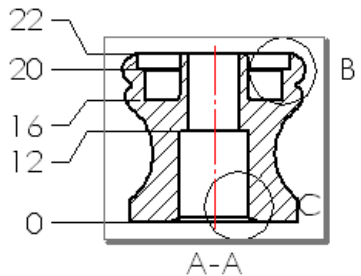

The check mark next to **Jog** is cleared and the jog in the leader is straightened.

To remove the chain arrows:

- 1 Right-click one of the dimensions in the ordinate group, and select **Properties**.
- 2 Clear the **Display as chain dimension** check box.
- 3 Click **OK**.

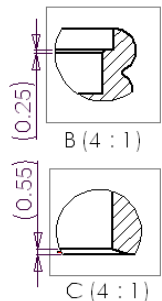

To add other dimensions to the drawing:

- 1 Click **Dimension** , then click the lines to be dimensioned.
- 2 Click to place the dimension.

NOTE: The dimensions that you add to drawings are *reference* dimensions. They are gray and appear in parentheses. You cannot edit the values. However, the values of reference dimensions change when the model dimensions change.

Adding Annotations

You can create several types of annotations in drawings.

You can specify a surface texture with a **Surface Finish Symbol**. You define a symbol that specifies the values and options for the finish you want, then attach it to an object.

- 1 Click **Surface Finish Symbol**  on the Annotations toolbar, or click **Insert, Annotations, Surface Finish Symbol**.

The **Surface Finish Symbol Properties** dialog box appears. Notice the preview of the symbol as you set the following options:

- **Symbol** - select **Basic** from the list
- **Direction of lay** - select **Circular** from the list
- **Roughness, Maximum** - type 32
- **Leader** - select **Always show leaders**, click to clear the **Smart** check box, and select the filled round **Arrow style**  from the list.

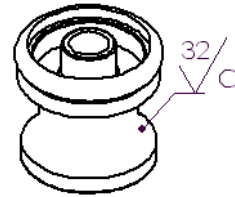



- 2 Click in the graphics area to place the leader on the isometric view, then click again to place the symbol.

You can place as many symbols as you wish without closing the dialog box.

- 3 Click **OK** to close the **Surface Finish Symbol Properties** dialog box.

You can drag the symbol and leader to any location. To edit the symbol, double-click the symbol, or right-click and select **Properties**.

You can attach a **Datum Feature Symbol** to a surface that appears as an edge, and then add a **Geometric Tolerancing** symbol.

- 1 Click **Datum Feature Symbol**  on the Annotations toolbar, or **Insert, Annotations, Datum Feature Symbol**. The pointer changes to .

The **Properties** dialog box appears.

- 2 Click the bottom horizontal line in the section view, then drag the symbol into position and click to place it.

The datum letters are assigned alphabetically.

- 3 Click **OK** to close the **Properties** dialog box.

- 4 Click **Geometric Tolerance** , or click **Insert, Annotations, Geometric Tolerance**.

The **Geometric Tolerance** dialog box appears.

- 5 Build the symbol as follows. As you add items, a preview of the resulting symbol is displayed in the preview box.

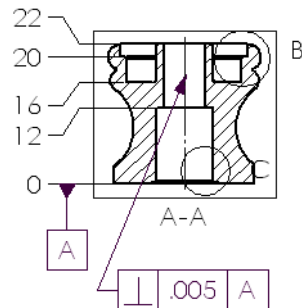

- In the first row of the **Feature control frames** section, click **GCS (Geometric Characteristic Symbol)**. In the **Symbols** dialog box, under **Symbol library**, select **Perpendicularity**. Click **OK**.
 - Enter a tolerance value of 0.005 in the **Tolerance 1** box.
 - Enter **A** in the **Primary** field.
- 6 Click on the centerline of the Section View to place the arrow, then click again to place the symbol.
- You can place as many symbols as you wish without closing the dialog box.
- 7 Click **OK** to close the **Geometric Tolerance** dialog box.
- 8 Click **Save**  to save the drawing.

Drawing an Exploded View



On a new sheet, add an assembly, showing the assembly in an exploded configuration.

To add a new sheet to the drawing:

- 1 Click **Insert, Sheet**, or right-click the sheet tab at the bottom of the window, and select **Add Sheet**.
- 2 In the **Sheet Setup** dialog box:
 - **Paper size** - select **A-Landscape**
 - **Scale** - set to 1:2
 - **Sheet Format** - select **None**
- 3 Click **OK**.

This drawing sheet is blank.

To add an exploded assembly:

- 1 Click **Named View**  or **Insert, Drawing View, Named View**.
- The **Named View** PropertyManager appears.
- 2 Open the file **Handle.sldasm** in directory `\installation directory\samples\tutorial\handle`.
 - 3 Click the ConfigurationManager tab  at the bottom of the window to change to the ConfigurationManager view.
 - 4 Expand the **Default** configuration.
 - 5 Right-click **ExpView1** and select **Explode**.
 - 6 Click in the graphics area of the assembly to select the view.
 - 7 Return to the drawing and select **Current** from the **View Orientation** list.
 - 8 Click in the graphics area of the drawing to place the view.

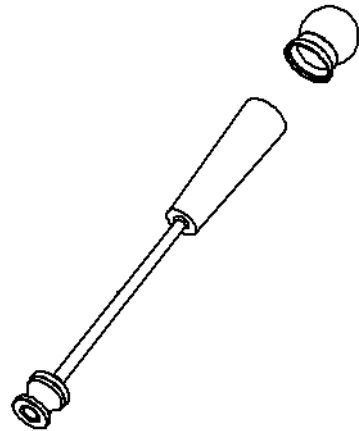

Adding Notes

A note can be free floating or placed with a leader. You can create multiple notes without closing the dialog box.

To start adding notes, without leader:

- 1 Click **Note**  on the Annotation toolbar, or click **Insert, Annotations, Note**.
The **Note Properties** dialog box appears.
 - Type a title, such as **Handle Assembly**, in the **Note text** box.
 - In the **Leader** section, select **No leaders**.
 - In the **Text justification** box, select **Center** from the list.
 - In the **Font** section, click to clear the **Use document's font** check box.
 - Click **Font**, select a **Font**, a **Font Style**, and a **Points** setting from the lists, and click **OK**.
- 2 Click in the graphics area to place the note.

To add more notes, with leaders:

- 1 With the **Note Properties** dialog box still open, edit the text and select options for the next note.
 - Type a title, such as **connector**, in the **Note text** box.
 - Select the **Always show leaders** check box.
 - Accept **Arrow style as Smart**
 - In the **Text justification** box, select **Left** from the list.
 - In the **Font** section, select the **Use document's font** check box.

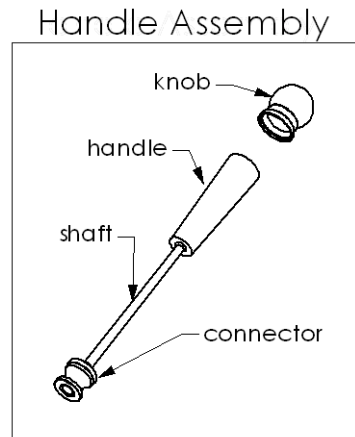

- 2 Click in the graphics area to place the leader, and again to place the note.
- 3 Repeat steps 1 and 2 to place notes for all the assembly components.
- 4 Click **OK** to close the **Note Properties** dialog box.

TIP: To edit note text, double-click the note.

To edit properties of a note, right-click the note and select **Properties**.
You can also edit the text in the **Properties** dialog box.

- 5 Click **Save**  to save the drawing.

Bill of Materials

In this chapter, you add a Bill of Materials (BOM) and balloons to a drawing of the universal joint assembly.

NOTE: You must have the Microsoft® Excel 97 or later spreadsheet program installed on your computer to insert a bill of materials into a drawing.

This chapter demonstrates:

- Setting Drawing and Detailing *Options*
- Inserting* a Bill of Materials
- Anchoring* a Bill of Materials
- Moving* a Bill of Materials
- Editing* a Bill of Materials
- Annotating the drawing with *Balloons*
- Saving* a Bill of Materials for use with other applications

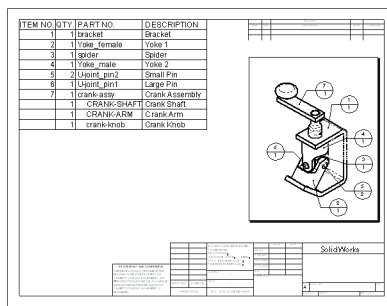

Starting a Drawing

The universal joint assembly that you created in the “Assembly Mates” chapter is the basis for working with the bill of materials in this chapter.

- 1 Open **u-joint.sldasm** in directory `\install_dir\samples\tutorial\universal_joint`.
- 2 Open a new drawing from the **Tutorial** tab.
- 3 Right-click anywhere on the drawing sheet and select **Properties**. Set **Scale** to 1:2, then click **OK**.
- 4 Insert a **Named View** of the isometric view of the **U-joint.sldasm** assembly.
- 5 Save the drawing as **U-joint.slddrw**.

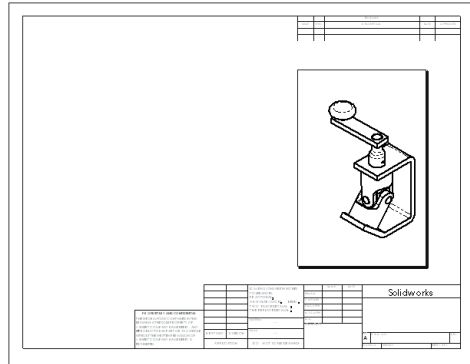

Drawing and Detailing Options

- 1 Click **Tools, Options**. On the **System Options** tab, click **Drawings**.
- 2 Make sure that the **Automatic update of BOM** check box is selected.
If this check box is not selected, you must delete and re-insert a BOM to update it. Changes that affect a BOM include adding, deleting, or replacing components, changing component names or custom properties, and so on.
- 3 On the **Document Properties** tab, under **Detailing**, click **Balloons**.
- 4 In the **Single balloons** section, in the **Style** box, select **Circular Split Line** from the list.
In the **Balloon text** section, the **Upper** box is **Item Number**, and the **Lower** box is **Quantity**.
- 5 Click **Detailing, Annotations Display**.
Make sure that **Display all types** is selected.
- 6 Click **OK** to close the **Options** dialog box.

Inserting a Bill of Materials

Because a drawing can contain views of different parts and assemblies, you must pre-select the view for which you want to create a bill of materials.

1 Select the drawing view.

2 Click **Insert, Bill of Materials**.

The **Select BOM Template** dialog box appears.

3 Click **Open** to use the default bill of materials template, **Bomtemp.xls**.

The **Bill of Materials Properties** dialog box appears.

4 Set the following items:

- Click to clear the **Use the document's note font when creating the table** check box. The table uses the font in the template.
- Select **Show assemblies and parts in an indented list**. Both the subassembly and its components appear in the bill of materials. The other choices are:

Show parts only - parts and sub-assembly *components* are listed, but not the sub-assemblies

Show top level subassemblies and parts only - the parts and *subassemblies* are listed, but not the subassembly components

- In the **Anchor Point** section, make sure that the following are selected:

Use table anchor point check box

Top Left from the **Anchor point coincident to list**

5 Click **OK** to close the **Bill of Materials Properties** dialog box.

A bill of materials is displayed. It lists the parts and subassembly in the universal joint assembly.

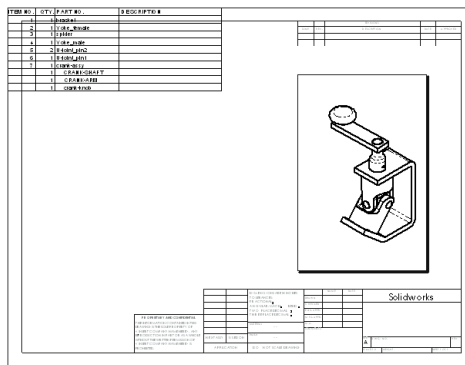



Anchoring a Bill of Materials

An *anchor point* is a point in the sheet format which you can set and to which you anchor a bill of materials. In the bill of materials, you can select the corner of the bill of materials to be coincident with the anchor point.

- 1 Right-click the BOM, and select **Anchor, Top Right**.

The BOM moves so that the top-right corner coincides with the anchor.

- 2 In the FeatureManager design tree, expand the **Sheet Format1** icon .
- 3 Right-click the **Bill of Materials Anchor1** icon , and select **Set Anchor**.

- 4 Click the top left corner of the inside border of the drawing sheet format, to set the anchor.

The anchor point is highlighted. You are in the **Edit Sheet Format** mode.

- 5 Right-click the graphics area, and select **Edit Sheet**.

The BOM is anchored at the inside border.

- 6 Right-click the BOM, and select **Anchor, Top Left**.

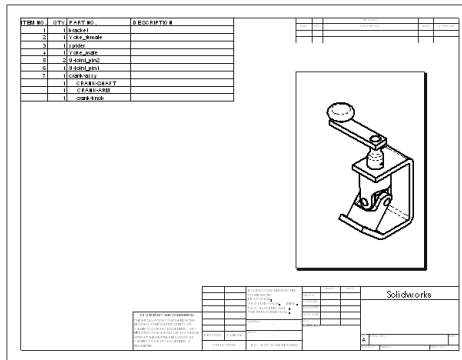

Moving a Bill of Materials

You can unlock the BOM from the anchor point and then move it to a new location.

- 1 Right-click the bill of materials and select **Anchor, Unlock from Anchor**.

- 2 Move the pointer over the bill of materials.

The pointer changes to the move shape .

- 3 Drag the table to a new location.

- 4 Right-click the bill of materials and select **Anchor, Lock to Anchor**.

The bill of materials returns to the anchor.

Editing a Bill of Materials

Next, enter descriptions for the items.

- 1 Right-click the bill of materials and select **Edit Bill of Materials**, or double-click the bill of materials.

While the bill of materials is active, it is displayed with shaded borders and row and column headers. Excel toolbars replace the SolidWorks toolbars.

- 2 To see all the rows, drag the lower-right corner of the border and resize the table.

You can also resize the columns and rows as in any Excel worksheet.

- 3 Click in cell **D2**, type a description, then press **Enter**.

Continue to add descriptions.

You can also resize the text, change the font, and so on.

- a) Select the text
 - b) Set the font size to 16 points
 - c) Click **Format, Row, AutoFit** and **Format, Column, AutoFit Selection** to adjust the column and row sizes.
- 4 Click outside the bill of materials to close it.

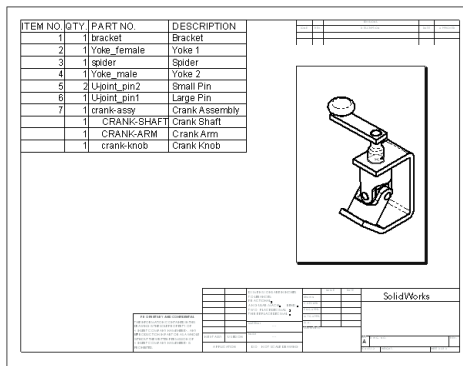

Inserting Balloons

Balloon callouts label the parts in an assembly drawing and relate them to item numbers on the bill of materials.

- 1 Click **Balloon**  on the Annotations toolbar, or click **Insert, Annotations, Balloon**.
- 2 Click a component in the drawing view.
A balloon attaches to the component. The numbers correspond to the item numbers (upper) and quantities (lower) in the bill of materials.
- 3 Click **Select** or press **Esc** to turn off the balloon tool.
- 4 To move the balloon or leader arrow, select and drag the balloon, or drag the leader by the handle.

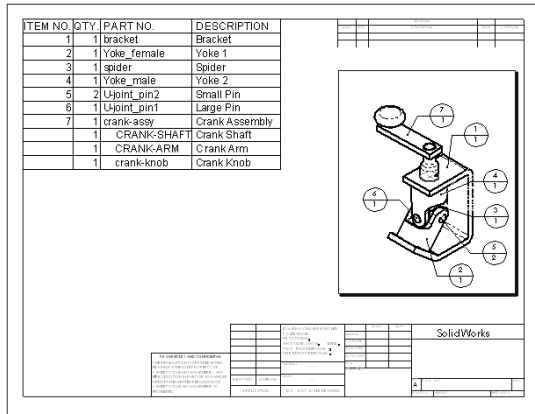

Saving a Bill of Materials

You can save the bill of materials as an Excel file for use with other applications.

- 1 Select the bill of materials.
- 2 Click **File, Save As**.

The **Save Bill of Materials Table** dialog box is displayed. Notice that the **Save as type** is set to **Excel Files (*.xls)** by default.

- 3 Type **Ujoint_BOM** in **File name** box and click **Save**.

The extension **.xls** is added to the filename, and the file is saved to the current directory. If you wish, you can navigate to a different directory, then save the file.

NOTE: The Excel file is not linked to the bill of materials in the drawing. If assembly components change, the bill of materials automatically updates, but the Excel file does not.

For more information about adding a bill of materials, see bill of materials in the *SolidWorks 2001 Online User's Guide*.

More about Drawings and Detailing



You can do much more with drawings than what is introduced in the examples in this guide. The following pages highlight additional SolidWorks functionality in drawings and detailing. For more information, see the *SolidWorks 2001 Online User's Guide*.

Drawings

In drawings, you have many options, formats, and views to consider.

Options for Drawings

The **Options** dialog box on the **Tools** menu contains many options for controlling aspects of drawings. In addition to the default sheet scale and detail view scaling, you can specify the type of projection, detail item snapping, default edge display, and many types of automatic placement, display, and updates.

Templates and Drawing Sheet Formats









When opening a new drawing, you can choose from standard templates, custom templates, or a blank template. You can add customized templates for drawings to the SolidWorks system, and you can add tabs to the **New SolidWorks Document** dialog box.

When adding a sheet to a drawing, you select a sheet size and format. You can customize a sheet format (to match your company's standard, for example), including text content and font, bill of materials anchor point, and bitmaps of your company logo. Then you can save the sheet format for future use.

You can modify the current drawing sheet, including such properties as sheet name, paper size, sheet scale, sheet format, type of projection, and the next view label. Sheet properties such as name, size, number, and scale have system-defined names that you can link to note text in the sheet format.

Views

The chapters on drawings in this guide introduced the Standard 3 View, Named View, Section View, and Detail View. Other possible views include the following:

- **Projection**  - a projection of an orthogonal view
- **Auxiliary**  - a projection unfolded normal to a reference edge in an existing view. You can select an edge, a silhouette edge, an axis, or a sketched line as the reference edge. You can toggle the view orientation while dragging the view and after placing the view.
- **Broken**  - an interruption of a long part that has a uniform cross-section
- **Relative to Model**  - an orthographic view defined by two orthogonal faces or planes in the model
- **Aligned Section**  - a section view aligned to a sketched section line
- **Section View of Assembly**  - similar to a section view of a part, but with the option of excluding components from being sectioned
- **Crop**  - crops the view outside a closed profile such as a circle. You can crop any view except a Detail View.
- **Detail**  - The profile for a Detail View can be any closed sketch. You can choose to display either the profile or its circle in the parent view. If you select **Circle**, you can choose a style for the detail note. You can drag the note anywhere except inside the circle.

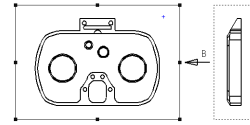

Projection view

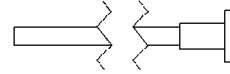

Broken view

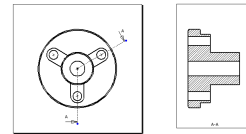

Aligned section view

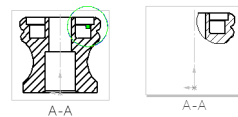

Crop view

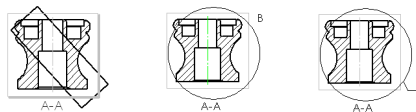

Detail profile, detail circle, note style with leader, and detail view

Other aspects of drawing views that you can control include:

- Editing View Properties, including scale, orientation, configuration, exploded state, and type of dimensions (projected or isometric).
- Turning off the automatic view update mode option so that performance is faster, then manually updating individual views, or all views at once, as necessary.
- Breaking the alignment of views that are automatically aligned. You can also align one drawing view with another.
- Rotating a drawing view around an edge or around its center point. You can copy and paste views, hide or show a view, and change the display mode of a view.

Show/Hide

You can show or hide views, components, and hidden edges in components.

- When you hide or show a view that has related views (**Auxiliary**, **Detail**, and so on), you are given the option of hiding or showing those related views also.
- In addition to hiding or showing components individually, you can hide as many components as you wish on the **Hide/Show Components** tab in the **Drawing View Properties** box. **Hide Behind Plane** is a quick method of hiding a number of components. The hidden components are listed on the **Hide/Show Components** tab.
- **Show Hidden Edges** is available for individual components from the shortcut menu when the view is in Hidden Lines Removed mode. Any number of components can be specified on the **Show Hidden Edges** tab in the **Drawing View Properties** dialog box.

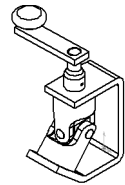

Complete assembly

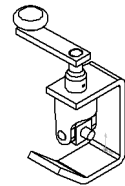

Hide Component

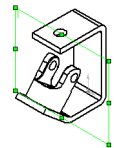

Hide Behind Plane

Layers

Layers in drawings assign line color, thickness, and style for entities in the layers. You can hide or show individual layers. New entities are automatically added to the active layer.

You can add dimensions, annotations, and sketch entities to layers. You can add components to layers, in both part and assembly drawings. Many dialog boxes (**Component Display Properties**, **Note Properties**, **Geometric Tolerance Properties**, and so on) include a **Layer** list for selecting a named layer for the entity.

Layer information is included when importing or exporting files in **.dxf** or **.dwg** format.

2D Sketching

Sketch tools and sketch relations work the same way in a drawing document as they do in a part or assembly document.

RapidDraft Drawings

RapidDraft™ drawings have a format designed so you can open and work in drawing files without the model files being loaded into memory.

- When you open a new drawing document, a **Create RapidDraft Drawing** check box appears in the **New SolidWorks Document** dialog box.
- When you open an existing drawing that is not a RapidDraft drawing, a **Convert to RapidDraft** check box appears.
- Once a drawing is converted to RapidDraft format, it cannot be converted back.

When you convert a drawing to RapidDraft, the drawing and model are both loaded into memory. When the conversion is complete, save the drawing. Close the drawing, which also closes the model, then open the drawing again. The drawing is now in RapidDraft mode.

- View borders in RapidDraft drawings are blue.
- If a part or assembly is needed for an operation in a RapidDraft drawing, you are prompted to load the model file. You can also load the model manually by right-clicking a view and selecting **Load Model**.
- Some changes, such as changes to a section line or detail profile, require a view update. When a drawing view requires an update, the view is displayed with a gray crosshatch pattern.

You can send RapidDraft drawings to other SolidWorks users without sending the model files. Other advantages include the following:

- Some engineers can work on the model while others add details and annotations to the drawing. When the drawing and model are synchronized, all the details and dimensions added to the drawing update to any geometric or topological changes in the model.
- The time required to open a drawing in RapidDraft format is significantly reduced because the model files are not loaded into memory. More memory is available to process drawing data.
- The RapidDraft format requires storing less surface data but more edge data. File size is directly related to the number of visible edges in the drawing.

Operations available in RapidDraft drawings when the model is not loaded include:

- Saving and opening drawings
- Adding dimensions, annotations, balloons, and empty views
- Changing scales, line formats, and view alignments
- Selecting edges, planes, sketches, origins, and axes
- Updating the drawing

Detailing

You can include items such as dimensions, notes, and symbols in part and assembly documents, and then import these dimensions and annotations from the model into a drawing. Once in the drawing, you can add other annotations and reference dimensions.

Options for Detailing

The **Options** dialog box on the **Tools** menu includes detailing options for setting the dimensioning standard, whether to show trailing zeros, details of center marks, witness lines, center lines, and fonts. You can control details of dimensions, notes, balloons, arrows, and virtual sharps.

Dimensions in Drawings

You can import dimensions from the model into all the drawing views at once, or into selected drawing views. The dimensions are imported only once for a part. In the drawing, you can add parallel, horizontal, and vertical reference dimensions in the same way as in model sketches. Silhouette edges and midpoints of linear edges are available for dimensioning.

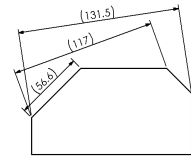

Vertex as baseline

Either an edge or a vertex can be the baseline for dimensions.

You can align dimensions in either a linear or radial direction, and you can distribute parallel and concentric dimensions so they are spaced uniformly. You can center dimension text between witness lines and offset dimension text from its arrows.

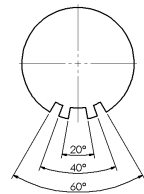

Concentric alignment

Depending on the type of dimension (linear, radius, reference, driving), you can also modify the following properties: driven, read only, dual dimension, arc condition, foreshortened radius, inside or outside arc, ordinate dimension as chain, and as inspection dimension.

Some of the dimension properties you can modify are: value, name, arrow style and placement, font, precision, witness lines, tolerance, units, and leader style. Many dimension properties are available in the PropertyManager.

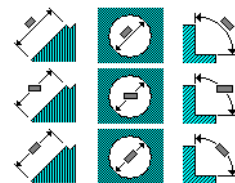

Leader options

Many display options are available on the dimension shortcut menu. Depending on the type of dimension selected, the **Display Options** menu includes items for slanting witness lines, centering or offsetting text, showing parentheses, showing as an inspection dimension, jogging or re-jogging ordinate, aligning ordinate, and adding to ordinate dimensions.

More about Drawings and Detailing

Dimension arrows have circular handles. When you click a handle, the arrows flip outside or inside. When you right-click a handle, a menu of arrowhead styles appears for changing the style of the dimension arrowhead individually.

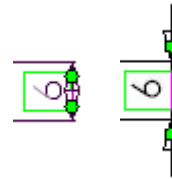







Flip arrows with dimension handles

Annotations

You can add many types of annotations to drawings. Functionality includes:

- Multiple annotations and multiple leaders
- Alignment tools, snap to grid, and inferencing for alignment
- Double-click to edit in place
- Link notes to document properties and embed hyperlinks in notes

In addition to the surface finish symbol, geometric tolerancing symbols, bill of materials, and balloons discussed in the “Advanced Drawings and Detailing” and “Bill of Materials” chapters, you can insert the following types of annotations into drawings:

- **Center Marks**  - to silhouette edges as well as circles and arcs
- **Hole Callouts**  - dimensions update if the model changes
- **Datum Targets**  - with targets as points, circles, or rectangles
- **Weld Symbols**  - including secondary weld fillets
- **Area Hatch** - on faces or in closed profiles
- **Cosmetic Threads**  - including conical threads
- **Stacked Balloons**  - with one leader for the set

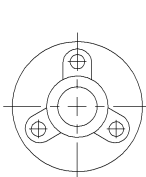

Center mark

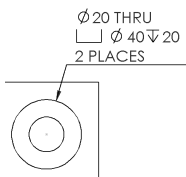

Hole callout

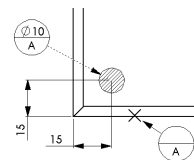

Datum target

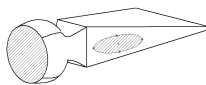

Area hatch

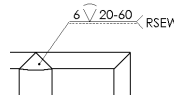

Weld symbol



Stacked balloons

Properties of a bill of materials available for editing include the configurations specified at the time of creation, which items to include in the table, how row numbers are assigned, and split tables. You can edit and format the text, specify how to list component configurations, add custom columns, and edit the item number in a balloon.



Special Topics

Sheet Metal Part

Mold Design

3D Sketching

Importing Files / Using FeatureWorks Software

Learning to Use PhotoWorks

SolidWorks Animator

More about SolidWorks Functionality

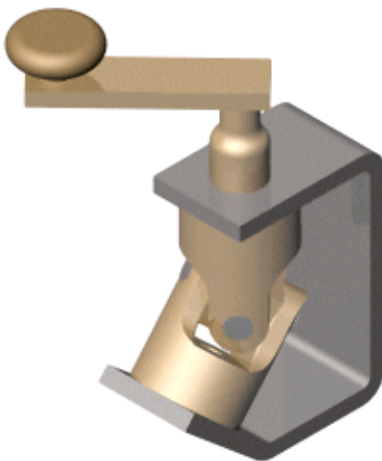

Sheet Metal Part

In this chapter, you create the sheet metal part shown here. This chapter demonstrates:

- ❑ Creating a *base flange*
- ❑ Adding a *miter flange*
- ❑ *Mirroring* the part and creating new bends
- ❑ Adding and bending a *tab*
- ❑ *Folding and unfolding* a single bend as well as the entire part
- ❑ Adding a *cut across a bend*
- ❑ Creating a sheet metal *drawing*

For more information about SolidWorks sheet metal functions, see the *SolidWorks 2001 Online User's Guide*.

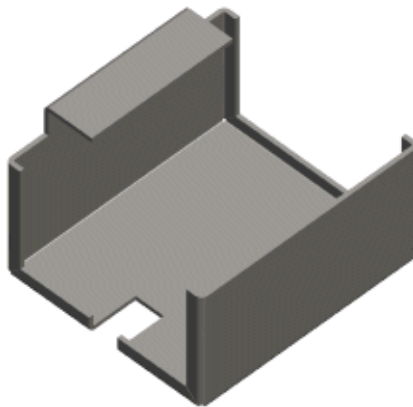

Creating the Base Flange

When developing a sheet metal part, you generally design the part in the folded state. This allows you to capture the design intent and the dimensions of the finished part.

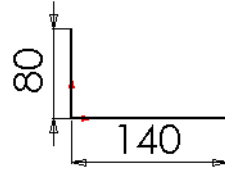

To create a sheet metal part of uniform thickness, sketch an open profile and use the *base flange* feature to create the thin feature and the bends.

- 1 Open a new part from the **Tutorial** tab and open a sketch on the **Front** plane.
- 2 Placing the lower left corner of the sketch on the origin, sketch and dimension the profile as shown. Add an **Equal** relation between the two vertical lines.
- 3 Click **Base-Flange/Tab**  on the Sheet Metal toolbar, or click **Insert, Features, Sheet Metal, Base Flange**.



NOTE: If the Sheet Metal toolbar is not visible, click **View, Toolbars, Sheet Metal**.

The **Base Flange** PropertyManager appears.

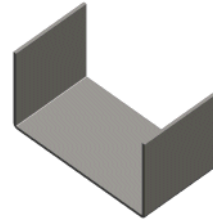

- 4 Under **Direction1**, leave **End Condition** as **Blind** and set the **Depth**  to 75mm.
- 5 Under **Sheet Metal Parameters**, do the following:
 - a) Set **Thickness**  to 3mm.
 - b) Set **Bend Radius** to 1mm. This is the default bend radius.
- 6 Click **OK** .

The sketch is extruded and the bends are automatically added.



Examining the FeatureManager Design Tree

A base flange feature creates three new features in the FeatureManager design tree. The following are the three new features:

-  **Sheet-Metal1.** The Sheet-Metal feature contains the default bend parameters. To edit the default bend radius, bend allowance, or default relief type, right-click the Sheet-Metal feature and select **Edit Definition**.
-  **Base-Flange.** The Base-Flange feature is the first solid feature of this sheet metal part.
-  **Flat-Pattern1.** The Flat-Pattern feature flattens the sheet metal part. Notice it is suppressed by default as the part is in its bent state. Unsuppress the feature to flatten the sheet metal part.

When the Flat-Pattern feature is suppressed, all new features that you add to the part are automatically inserted above the Flat-Pattern feature in the FeatureManager design tree. When the Flat-Pattern feature is unsuppressed, new features go below it in the FeatureManager design tree and are not shown in the folded part.

Adding a Miter Flange

You can add flanges to your sheet metal part with corners that are automatically mitered.

- 1 Select the inside vertical edge approximately as shown and click **Sketch**  to open a new sketch.

A sketch plane is created normal to the selected edge with its origin at the closest endpoint of the edge.

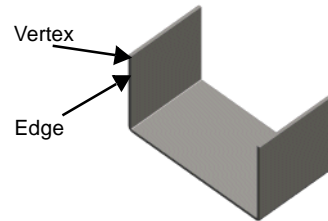

- 2 Sketch a horizontal line starting from the inside vertex shown extending towards the middle of the part. Dimension the line to 8mm.

- 3 Click **Miter Flange**  on the Sheet Metal toolbar, or click **Insert, Features, Sheet Metal, Miter Flange**.

The **Miter Flange** PropertyManager appears.

- 4 Click the handle that appears on the selected edge.

The five tangent edges appear in the **Along edges** box under **Miter Parameters**.

Also, a preview of the miter flange appears on the model.

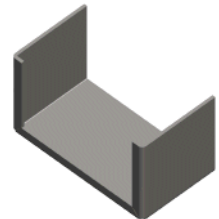

- 5 Click **OK** .

The flange is added to the selected edges. Notice the bend reliefs are automatically added to allow the miter flanges to fold and unfold.

- 6 Save the part as **Cover.sldprt**.

Mirroring the Sheet Metal Bends

When you mirror a sheet metal part, many of the bends are mirrored as well. The only bends that are not mirrored are those that are normal to and coincident to the mirror plane; those bends are extended.

- 1 Click **Hidden in Gray** .
- 2 Click **Insert, Pattern/Mirror, Mirror All**.

The **Mirror All** dialog box appears.

- 3 Select one of the back planar faces as the **Mirror Plane**. Use **Select Other** from the shortcut menu if necessary.

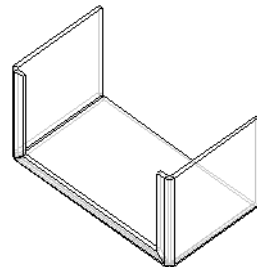

Special Topics

- 4 Click **OK** and click **Shaded** .

The entire part is mirrored as well as the sheet metal bends from the miter flange.

- 5 Expand the **Mirror1** feature in the FeatureManager design tree and notice that there are new bends to include the mirrored geometry.

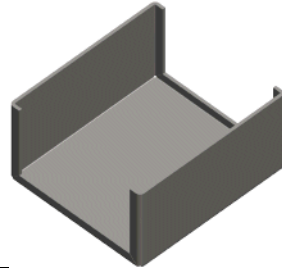

Adding a Tab

- 1 Open a sketch on the vertical face shown.
- 2 Sketch a rectangle above the sheet metal body with its lower edge coincident to the edge shown. Dimension the rectangle to 50mm high and 100mm wide.
- 3 Add a coincident relation between the midpoint of one of the horizontal lines of the rectangle and the **Front** plane.

TIP: To select the midpoint of a line or edge, right-click the line or edge and click **Select Midpoint**.

The sketch should look like this when you are done.

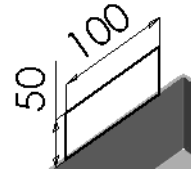
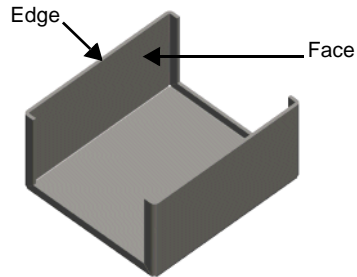

- 4 Click **Base-Flange/Tab** .

The tab is added to the part. You do not need to specify a depth because the SolidWorks software links the thickness of the tab to the thickness of the base flange.

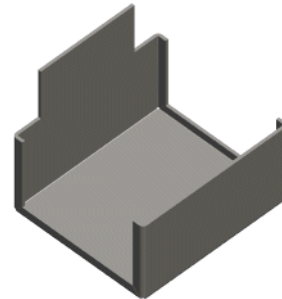

Bending the Tab

Once you add a tab, you must specify how to bend it.

- 1 Select the same vertical face from the previous section and open a sketch.
- 2 Sketch a horizontal line of any length. Dimension it to 30mm below the top of the tab as shown.

The bend line for a Sketched Bend does not have to be the exact length of the faces you are bending.

- 3 Click **Sketched Bend**  on the Sheet Metal toolbar, or click **Insert, Features, Sheet Metal, Sketch Bend**.

The **Sketched Bend** PropertyManager appears.

- 4 Under **Bend Parameters**, do the following:
 - Select the vertical face that you are sketching on as the **Fixed face**.
 - Set **Bend position** to **Bend outside**.
 - Make sure **Bend Angle** is set to 90° and the **Use default radius** check box is selected.
- 5 Click **OK** .
- 6 Save the part.

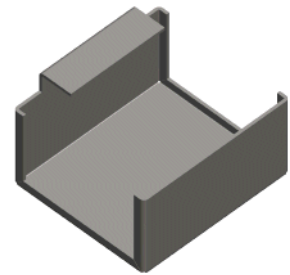
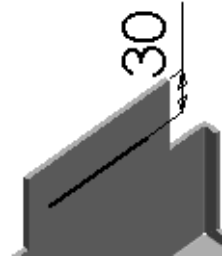

Adding a Cut Across a Bend

To cut across a bend, you start by unfolding only the bend that you want to cut across.

- 1 Click **Unfold**  on the Sheet Metal toolbar, or click **Insert, Features, Sheet Metal, Unfold**.

The **Unfold** PropertyManager appears.

- 2 Select the face shown as the **Fixed face** and the bend shown as the **Bends to unfold**.

Notice that you can only select bends when the **Bends to unfold** box is active.

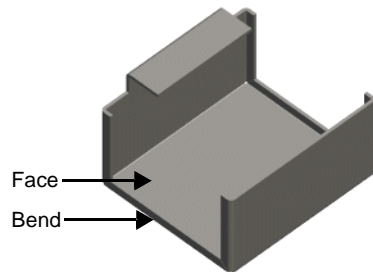



Special Topics

3 Click **OK**

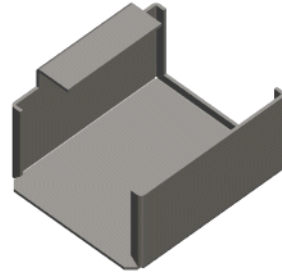
The selected bend only is unfolded.



Next, you create a sketch and cut through the bend.

- 1 Open a sketch on the face shown, and sketch and dimension a rectangle as shown. The 60mm dimension goes from the left edge of the rectangle to the origin.
- 2 Click **Extruded Cut**  or **Insert, Cut, Extrude**. Select **Through All** as **End Condition**, then click **OK** .

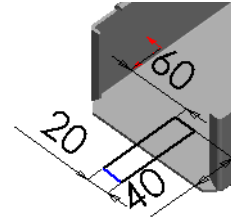

The cut goes through the bend region.

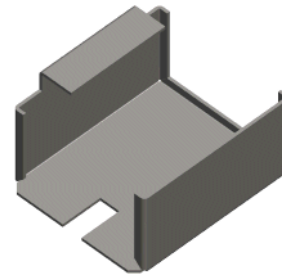

Now that you made your cut, fold the bend back to its bent state.

- 1 Click **Fold**  on the Sheet Metal toolbar, or click **Insert, Features, Sheet Metal, Fold**.

The **Fold** PropertyManager appears.

- 2 Select the bottom face of the sheet metal part as the **Fixed face**.
- 3 Click **Collect All Bends** to collect all the unfolded bends.

The unfolded bend appears in the **Bends to fold** box.

- 4 Click **OK** .

The part returns to its fully bent state with the cut across the bends.

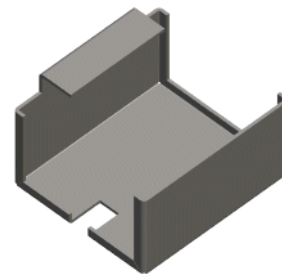

Folding and Unfolding the Entire Part

You can flatten all the bends of your sheet metal part at once.

- 1 Select the **Flat-Pattern1** feature in the FeatureManager design tree and click **Flattened**  on the Sheet Metal toolbar.

The flattened sheet metal part appears with all of the bend lines shown.

- 2 To fold the part back up, select the **Flat-Pattern1** feature again and click **Flattened**  again.
- 3 Save the part.

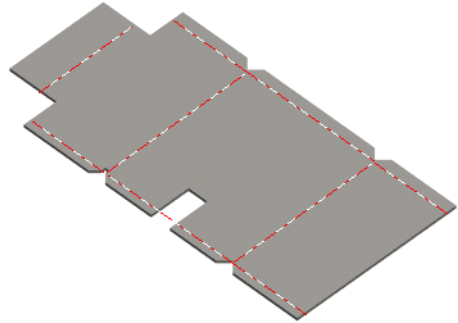

Creating a Sheet Metal Drawing

Now create a drawing of the cover. Start with a view of the folded model, and then add a view of the unfolded model.

- 1 Open a new drawing from the **Tutorial** tab.
- 2 Click **Named View** , or click **Insert, Drawing View, Named View**.

The **Named View** PropertyManager appears.

The pointer  indicates that you may select a model to display in the drawing.

- 3 Tile the windows so you can see the cover and the drawing.
- 4 Click anywhere in the **Cover.sldprt** window.

The pointer  indicates that you may select a location in the drawing to place the named view.

- 5 Click where you want to place the view in the drawing.

The **Named View** PropertyManager appears. Note its similarity to the **Orientation** dialog box.

- 6 Select ***Isometric** from the list to switch to an isometric view.
- 7 Maximize the drawing window.

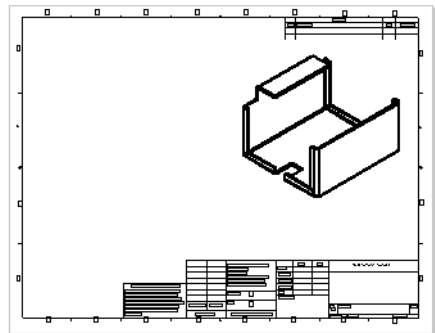

Special Topics

Next, add the view of the unfolded model. A flat pattern view is automatically added when you create a sheet metal part.

- 1 Click **Named View**  again.
- 2 Select the isometric view as the model you want to use.
- 3 Click where you want to place the view in the drawing.
- 4 In the **Named View** PropertyManager, do the following:
 - a) Select **Flat pattern** from the **View Orientation** list.
 - b) Select the **Custom Scale** check box and set the scale to 1:3.
- 5 Click in the graphics area to see the changes take effect.
- 6 Save the drawing as **Cover.sldrw**.

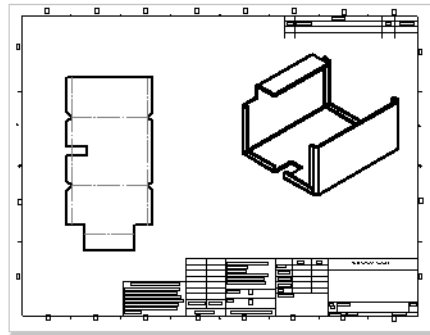

Mold Design

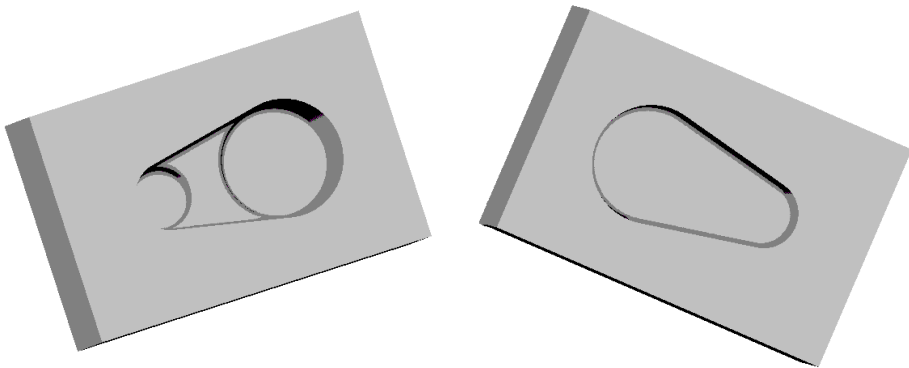

In this chapter, you create a design part, then you develop a mold from which the part can be formed. This chapter discusses the following topics:

- ❑ *Linking* dimension values
- ❑ Creating an *interim assembly* from a design part and a mold base part
- ❑ *Editing in context* by inserting a *cavity*
- ❑ *Deriving* component parts
- ❑ Understanding *external references*





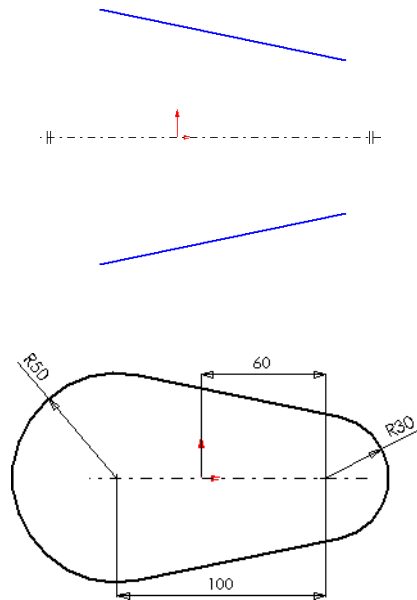

Creating the Design Part

The first step is to create the part for which you want to make a mold. You create it as a solid model, just as you do any other part.



- 1 Open a new part from the **Tutorial** tab and open a sketch.
- 2 Sketch a horizontal centerline through the origin.
- 3 Click **Mirror**  or **Tools, Sketch Tools, Mirror**.
- 4 Sketch a sloping line on one side of the centerline as shown.
- 5 Click **Mirror** again to turn mirroring off.
- 6 Click **Tangent Arc**  or **Tools, Sketch Entity, Tangent Arc**.
- 7 Sketch and dimension the two arcs as shown. To dimension the distance between the arcs, select anywhere on the arcs.

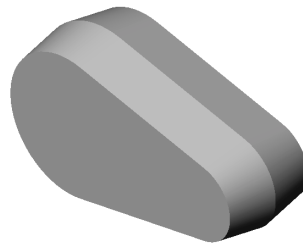

- 8 Click **Extruded Boss/Base**  or **Insert, Base, Extrude**.
- 9 In the **Base-Extrude** PropertyManager, under **Direction 1**:
 - Set **End Condition** to **Mid Plane** and **Depth**  to 60mm.
 - Click **Draft On/Off** , and set **Angle** to 10°.
 - Click to clear the **Draft Outward** check box, if necessary.
- 10 Click **OK** .





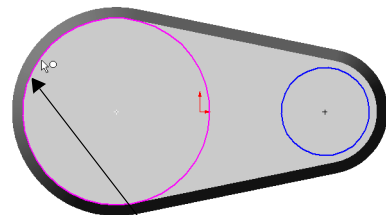
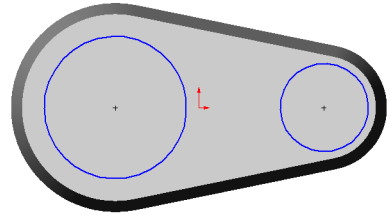

Adding Bosses

- 1 Open a new sketch on the front face of the part, and click **Normal To** .
- 2 Sketch two circles approximately as shown.
- 3 Add a coradial relation to align the center points of the large circle and the large arc, making them the same size:
 - a) Click **Add Relation**  or **Tools, Relations, Add**.
 - b) Select the circle and the inside edge of the larger arc (the drafted edge).
 - c) Select **Coradial**.
 - d) Click **Apply**.
- 4 Add a coradial relation between the smaller circle and arc, then close the **Add Geometric Relations** dialog box.

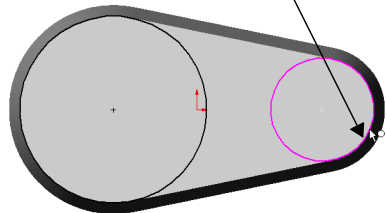

Coradial relation



- 5 Click **Extruded Boss/Base** , and do the following:
 - Set **End Condition** of **Blind** with a **Depth**  of 20mm.
 - Click **Draft On/Off** , and set **Angle** to 30°.
 - Click to clear the **Draft Outward** check box, if necessary.
- 6 Click **OK** .

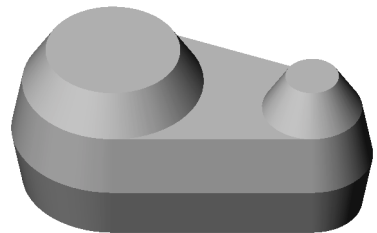

Linking Dimension Values

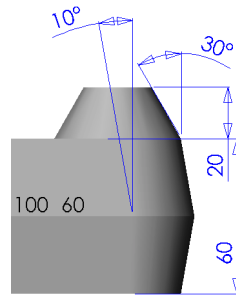

You can make the draft angles of the boss and the base equal by linking the dimension values. Then, if you change the value of either draft angle, the other draft angle updates accordingly.

- 1 In the FeatureManager design tree, right-click the **Annotations** folder , and select **Show Feature Dimensions**.
- 2 Right-click the dimension of the draft angle of the base (10°), and select **Link Values**.
- 3 Type **draft** in the **Name** box, then click **OK**.
- 4 Right-click the dimension of the draft angle of the boss (30°), and select **Link Values**.



- 5 Click the arrow beside the **Name** box, select **draft** from the list, and click **OK**.

Each time you create a new **Name** variable, it is added to this list.

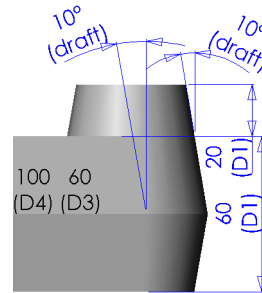

- 6 Click **Tools, Options**. On the **System Options** tab, click **General**.
- 7 Select the **Show dimension names** check box, then click **OK**. Notice that the draft angles have the same name.
- 8 Click **Rebuild**  or **Edit, Rebuild**. The part rebuilds with the boss extrusion at the same draft angle as the base.
- 9 Double-click the draft angle of either the base or boss, and change it to 5° .
- 10 Click **Rebuild** . The draft angle changes on both the base and the boss.



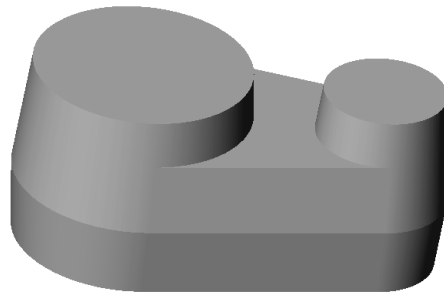

- 11 To turn off the visibility of the dimensions, right-click the **Annotations** folder , and deselect **Show Feature Dimensions**.
- 12 Save this part as **Widget.sldprt**.

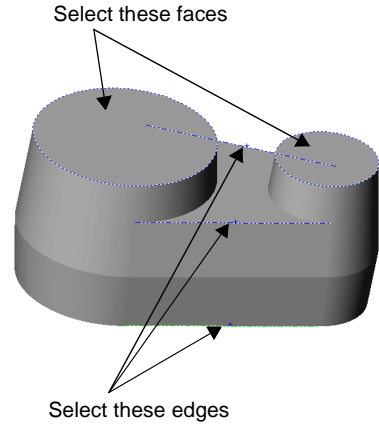

Rounding the Edges

- 1 Click **Fillet**  or **Insert, Features, Fillet/Round**.
- 2 Select the two faces and three edges shown.
- 3 Set the **Radius**  to 5mm.
- 4 Select the **Tangent propagation** check box.



- 5 Click **OK** .
- 6 Save the part.

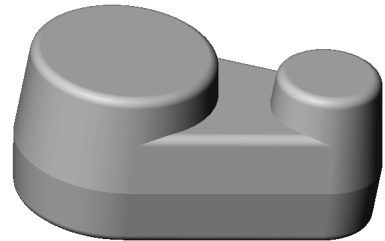



Creating the Mold Base

The next step is to create the mold base part, a solid block large enough to accommodate the design part (the part to be molded).

- 1 Open a new part from the **Tutorial** tab and open a sketch.
- 2 Sketch a rectangle starting at the origin and dimension it to 300mm by 200mm.
- 3 Click **Extruded Boss/Base**  or **Insert, Base, Extrude**. Extrude the rectangle with **End Condition** as **Blind** and **Depth** of 200mm.
- 4 Save the part as **Box.sldprt**.

Creating an Interim Assembly

This section describes how to create an interim assembly, bringing together the design part and the mold base.

- 1 Open a new assembly from the **Tutorial** tab and click **View, Origins** to show the origins.
- 2 Tile the windows. (Click **Window, Tile Horizontally** or **Tile Vertically**.)
There should be three windows open: **Widget.sldprt**, **Box.sldprt**, and **Assem1**. (Close any other windows.)
- 3 In the **Box.sldprt** window, click on the part name **Box** in the FeatureManager design tree, drag it into the **Assem1** window, and drop it on the origin in the graphics area. Watch for the  pointer. The planes of the box are aligned to the planes of the assembly, and the component is fixed in place.
- 4 Drag the widget from the graphics area of the **Widget.sldprt** window, and drop it in the assembly window beside the box in the graphics area.
- 5 Maximize the assembly window, and change the view orientation to **Isometric** .
- 6 In the FeatureManager design tree, click the  beside each component to expand the view of the features.

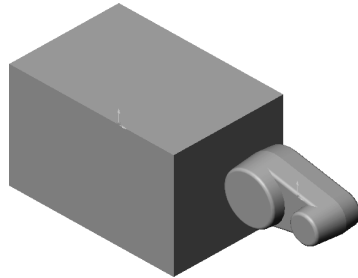







Centering the Design Part in the Mold Base

Now you need to position the design part to center it within the mold base. You can place the widget roughly where you want it by dragging. Position the part more precisely by using *distance mates* between the planes of the components.

To see the widget inside the box, use **Hidden In Gray** or **Wireframe** display mode. Or, you can make the box transparent to see the widget inside, even in **Shaded** mode.

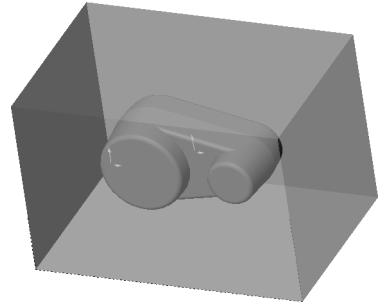

- 1 Right-click the **Box** component in the FeatureManager design tree, and select **Component Properties**. Click **Color**, then click **Advanced**.
- 2 In the **Advanced Properties** dialog box, drag the slider for **Transparency** to the right, a little less than halfway. Click **OK** to close each of the dialog boxes.

- 3 Click **Move Component** , and click the widget component in the graphics area. Drag the widget into the box. Notice how you can see through the box. Change the view orientation, and continue to move the widget until it is roughly in the center of the box.
- 4 Click **Mate**  or **Insert, Mate**.
The **Mate** PropertyManager appears.
- 5 Click the FeatureManager tab  to access the flyout FeatureManager design tree.
- 6 Click the **Front** plane of the **Box** and the **Front** plane of the **Widget**. Click **Distance** , specify 100mm, and click **Preview**.
- 7 Click **Rotate View** , and rotate the assembly to check the position of the widget. If necessary, click to clear the **Flip dimension** check box, and click **Preview** again.
- 8 Click the pushpin  in the **Mate** PropertyManager to keep it in place for the next few steps.
- 9 Click **OK** .
- 10 Add another distance mate, this time between the **Top** plane of the **Box** and the **Top** plane of the **Widget**. Specify a distance of 100mm, click **Preview**, and click to clear the **Flip dimension** check box if necessary.
- 11 Repeat for the **Right** plane of the components, with a distance of 150mm.
The widget should be centered in the box.
- 12 Close the **Mate** PropertyManager.
- 13 Save the assembly as **Mold.sldasm**.





Creating the Cavity

In this section, you edit the mold base component **Box** in the context of the assembly. You change the box from a solid block to a block with a *cavity* in the middle, shaped like the design component **Widget**.

- 1 Click **Hidden in Gray** .
- 2 Click the **Box** component in the FeatureManager design tree or the graphics area, and click **Edit Part**  on the Assembly toolbar.

The **Box** component changes to pink in the graphics area and in the FeatureManager design tree. The status bar in the lower-right corner displays “Editing Part.”

NOTE: It is important to be aware that you are editing the *part*, not the *assembly*, because the changes you make are reflected in the original part document, **Box.sldprt**.

- 3 Click **Cavity**  on the Mold Tools toolbar, or click **Insert, Features, Cavity**.
The **Cavity** dialog box appears.
- 4 Select **Widget** in the FeatureManager design tree.
The name of the part appears in the **Design component** box.
- 5 Set **Type** to **Component Centroids, Scaling Factor in %** to 2, and make sure the **Uniform** check box is selected.
These settings control how the cavity is enlarged to compensate for material shrinkage.
- 6 Click **OK** to create a cavity in the shape of the **Widget** part.
- 7 Return to assembly editing mode by clicking **Edit Part** .
- 8 Save the assembly.

Listing External References

Examine the FeatureManager design tree. The **(f)Box<1> ->** component contains a **Cavity1 ->** feature. The **->** arrow indicates an *external reference*. This occurs when you reference one part (or feature) to create a feature in another part. The new feature is dependent on the referenced feature of the other part.

A cavity has an external reference to the design part on which it is based. Therefore, if you modify **Widget**, the **Cavity1** feature of **Box** updates to reflect that change. Notice the **Update Cavity1 in Box** feature at the bottom of the design tree.

To list the external references, right-click the part or feature with the arrow, and select **List External Refs**.

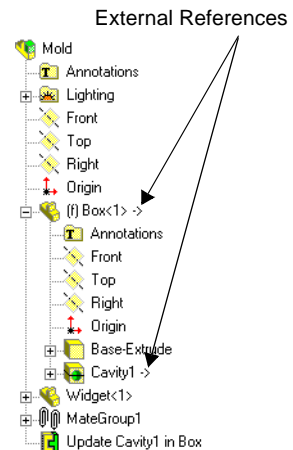

NOTE: External references update automatically only if all of the documents involved are open when a change is made. Otherwise, the references are considered to be *out-of-context*. To update out-of-context references, you must open and rebuild the document where the reference was created (in this example, the mold assembly).

Cutting the Mold

The last step is to cut the box in half to make the pieces of the mold. You *derive* the parts of the mold from the edited **Box** component.

- 1 Select the **Box** component, either in the graphics area or the FeatureManager design tree, and click **File, Derive Component Part**.

A part window appears for the derived part. A derived part always has another part as its first feature. The first feature has an arrow -> after the name, because it has an external reference to the part from which you derived it. You can list the external references as described in the previous section.

- 2 Click **Isometric** , then click either **Hidden in Gray**  or **Wireframe**  to see the cavity inside the box.

- 3 Select the narrow face of the box closest to you, and open a new sketch.

- 4 Select the edge of the cavity closest to the end of the box.

This edge is on the plane where you want to separate the mold.

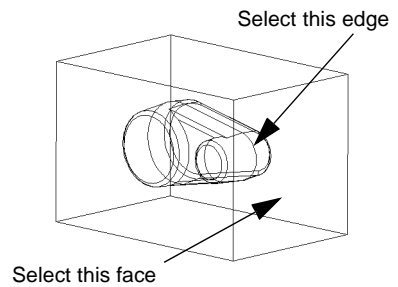

- 5 Click **Convert Entities**  or **Tools, Sketch Tools, Convert Entities** to project the edge onto the sketch plane.

- 6 Click the line and drag each endpoint so that the line is wider than the box.

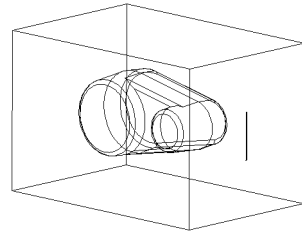



- 7 Click **Extruded Cut**  or **Insert, Cut, Extrude**. In the **Cut-Extrude PropertyManager**:

- Make sure **End Condition** is set to **Through All**.
- Leave the **Flip side to cut** check box cleared.

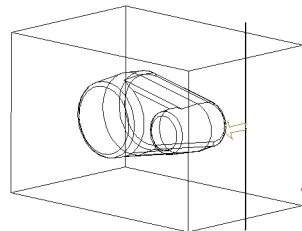
Notice the direction of the arrow in the graphics area. It points to the side where the material will be *removed*.



Special Topics

- 8 Click **OK** .
- 9 Click **Shaded** , and rotate the part to see the cavity.
- 10 Save this half of the mold as **Top_mold.sldprt**.
- 11 To create the other half of the mold, return to the **Mold** assembly window and repeat Steps 1 through 7.
Reverse the direction of the cut by selecting the **Flip side to cut** check box in the **Cut-Extrude** PropertyManager.
- 12 Save this half of the mold as **Bottom_mold.sldprt**.

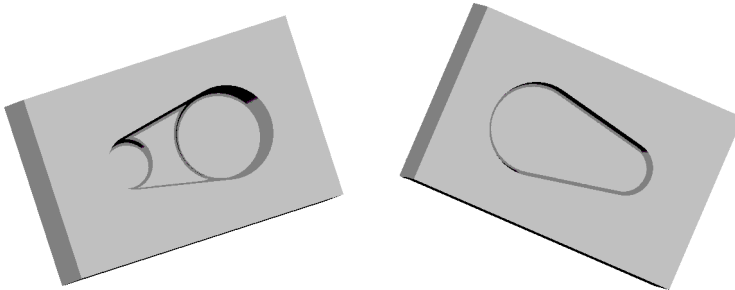
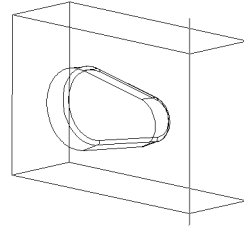

3D Sketching

Using SolidWorks 2001, you can create 3D sketches. You can use a 3D sketch as a sweep path, as a guide curve for a loft or sweep, a centerline for a loft, or as one of the key entities in a piping system. (For more information about the SolidWorks Piping add-in, see the *SolidWorks 2001 Online User's Guide*.)

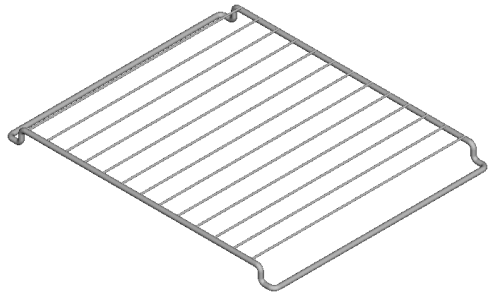

This chapter introduces you to 3D sketching and describes the following concepts:

- Sketching relative to *coordinate systems*
- Using the *space handle*
- Dimensioning* in 3D space
- Relations* available in 3D sketching





3D Sketching

To begin a 3D sketch, click **3DSketch**  on the Sketch toolbar, or click **Insert, 3D Sketch**. The sketch tools that are available in 3D sketching are **Line**, **Centerline**, **Fillet**, **Chamfer**, **Point**, **Spline**, **Convert Entities**, **Intersection Curve**, **Face Curves**, **Trim**, **Extend**, and **Construction Geometry**.

3D sketching consists of lines and arcs in series. You use **Line**  for sketched lines, and use **Fillet**  to round the intersections of sketched lines. To create an arc, select the **Fillet** tool and click two intersecting line segments, or click their common point.

You can use **Centerline**  and **Point**  for construction geometry.

- The coordinate system.** By default, you sketch relative to the default coordinate system in the model.
 - To switch to one of the other two default planes, click the desired sketch tool, and press the **Tab** key. The origin of the current sketch plane is displayed.
 - To change the coordinate system for your 3D sketch, click the desired sketch tool, hold down the **Ctrl** key, and click a plane, a planar face, or a user-defined coordinate system.
 - If you select a plane or a planar face, the 3D sketch planes rotate so that the XY sketch plane is aligned with the selected item.
 - If you select a coordinate system, the 3D sketch planes rotate so that the XY sketch plane is parallel to the XY plane of the coordinate system.
- Space Handle.** A graphical assistant helps you maintain your orientation while you sketch on several planes. This assistant is called a *space handle*. The space handle appears when the first point of a line is defined on a selected plane. Using the space handle, you can select the axis along which you want to sketch. 
- Dimensioning.** You can sketch lines to the approximate length, and then dimension them exactly.
 - Create a length dimension by selecting two points, a line, or two parallel lines.
 - Create an angular dimension by selecting either three points or two lines.
- Geometric Relations.** You can add relations to points and lines in a 3D sketch, using **Add Relations** . Also, relations are automatically added for 3D sketch lines.
 - As you sketch a line, the line snaps to one of the major directions, X, Y, or Z, if applicable, and is constrained as **Horizontal**, **Vertical**, or **Along Z**, respectively. The relations are added with respect to the current coordinate system for the 3D sketch.
 - You are not restricted to drawing lines along one of the three major directions. You can sketch in the current sketch plane at an angle to one of the major directions, or you can sketch out-of-plane if the endpoint of the line snaps to existing model geometry.

- ❑ **Line snap.** During the creation of a line, you can snap the line to geometry that already exists in the part, such as model surfaces or vertices, and sketch points.
 - Snap is not enabled if you are sketching in one of the major coordinate directions.
 - If you are sketching on a plane, and the system infers a snap to a non-planar point, a temporary 3D graphics box is displayed to indicate an off-planar snap.
- ❑ **Virtual sharps.** When you create an arc with the **Fillet** tool, the original common point of the lines is displayed as a *virtual sharp*. To change the display of the virtual sharp, click **Tools, Options**. On the **Document Settings** tab, under **Detailing**, select **Virtual Sharps**. Choose one of the styles that are depicted.
 - You can add dimensions and relations to virtual sharps in a 3D sketch.
 - If you delete an arc, the lines extend to meet at the virtual sharp.
 - If you delete a line used to create a fillet, any arc it was joined with remains. The virtual sharp becomes a sketch point.

Using a 3D Sketch to Create an Oven Rack Frame

The outer frame of a wire oven rack is built by sweeping a circle along a 3D sketch.

After you complete half of the rack, then you can take advantage of the part's symmetry and use the **Mirror All** function to finish the model.

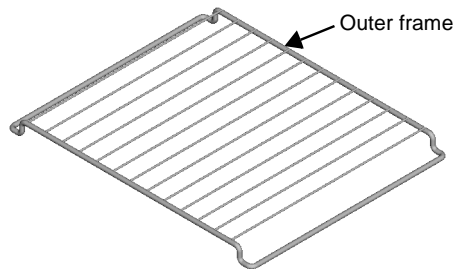



To create the 3D sketch of the outer frame:

- 1 Open a new part on the **Tutorial** tab, and click **Isometric**  to change the view orientation.

TIP: It is easier to create a 3D sketch in an isometric orientation because the X, Y, and Z directions are visible.



- 2 Click **3D Sketch**  or click **Insert, 3D Sketch**, to open a new sketch.

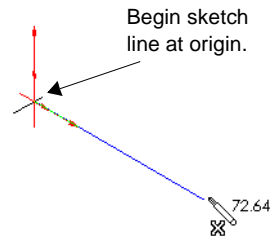

Special Topics

- 3 Click **Line**  and sketch a 135mm line on the XY plane  from the origin along the X axis. The pointer changes to  while sketching along the X axis.

TIP: Sketch the line to an approximate length, then dimension to the exact length later.



- 4 Click **Select**  and click the beginning endpoint of the line. Make sure that the endpoint is exactly at the point of the origin (0, 0, 0 as shown in the PropertyManager). Click **Add Relations**  and add a **Fix** relation.
- 5 Click **Line**  and continue sketching the other lines from the endpoint of the previous line. Each time you begin a new line, the origin for the current coordinate system is displayed at the beginning of the new line to help orient you.

- Sketch down the Y axis  for 15mm.
- Sketch along the X axis for 15mm.
- Press **Tab** to change the sketch plane to the YZ plane .
- Sketch along the Z axis  for 240mm.
- Press **Tab** twice to change the sketch plane back to the XY plane.
- Sketch back along the X axis for 15mm.
- Sketch up the Y axis for 15mm.
- Sketch back along the X axis for 135mm.

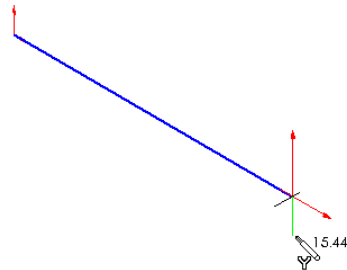

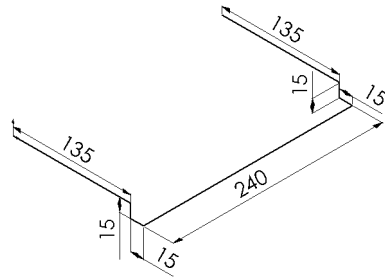

- 6 Dimension each of the lines as shown.
- 7 Click **Fillet**  on the Sketch Tools toolbar, or click **Tools, Sketch Tools, Fillet** and fillet each intersection with a 5mm fillet.
- 8 Close the sketch.
- 9 Save the part as **Rack.sldprt**.

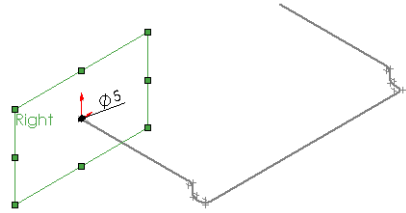

To complete the base feature, one half of the outer frame, you sweep a 5mm diameter circle along the 3D sketch path.

- 1 Open a 2D sketch  on the **Right** plane and sketch a 5mm diameter circle at the origin.
- 2 Close the sketch.





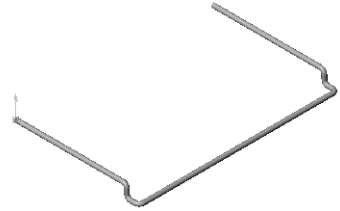

- 3 Click **Sweep** , or **Insert, Base, Sweep**.
The **Base-Sweep** PropertyManager appears.
- 4 Under **Profile and Path**, select the circle (**Sketch1**) for the **Profile**, and select the 3D sketch (**3DSketch1**) for the **Path**.
- 5 Click **OK** .



Extruding the Supports

Make a linear pattern of extrusions that extend from one side of the frame to the other.

- 1 Open a 2D sketch  on the **Front** plane and sketch a circle on what appears to be the face of the frame. (The **Front** plane is actually in the center of the frame wire.)
- 2 Dimension the center of the circle 11mm from the origin.
- 3 Dimension the diameter of the circle to 4mm.
- 4 Click **Extruded Boss/Base**  or **Insert, Boss, Extrude**.
The **Boss-Extrude** PropertyManager appears.
- 5 Under **Direction 1**, set the **End condition** to **Blind**, and **Depth** to 240mm. Click **Reverse direction**  and look at the preview to be sure the extrusion is moving in the correct direction to meet the other side of the frame.
- 6 Click **OK** .

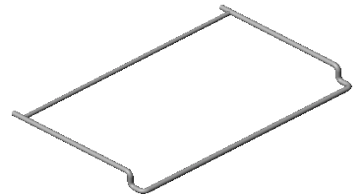
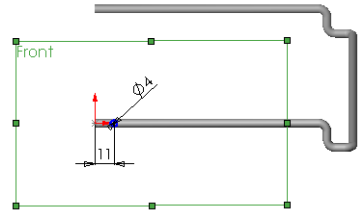

Special Topics

Now pattern the extrusion.

- 1 Click **View, Temporary Axes** to turn on the display of all temporary axes.
- 2 Select **Boss-Extrude1** and click **Linear Pattern**  or **Insert, Pattern/Mirror, Linear Pattern**.

The **Linear Pattern** PropertyManager appears.

- 3 Click the temporary axis on the face of the frame where you sketched the circle.

An arrow appears on the frame that points in the direction the pattern will take, and **Axis <1>** appears in the **Pattern Direction** box.

- 4 Under **Direction 1**:

- Click **Reverse direction**  if necessary. Check the preview for the direction of the pattern.
- Set **Spacing** to 22mm.
- Set **Number of Instances** to 6.

- 5 Click **OK** .

The extrusion pattern is completed.

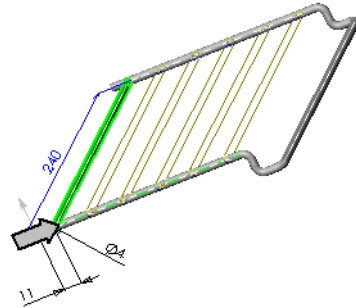

Use the **Mirror All** function to complete the wire rack.

- 1 Click **Insert, Pattern/Mirror, Mirror All**.

The **Mirror All** dialog box appears.

- 2 Rotate the half-rack that you created and click on the end face of the frame.

Face <1> appears in the **Mirror Plane** box.

- 3 Click **OK**.

The rack is completed.

- 4 Save the model.

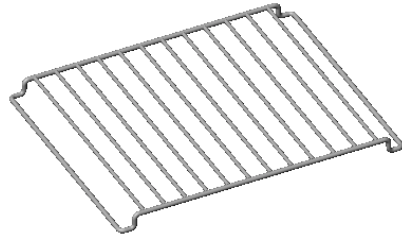
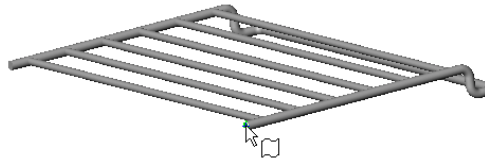

Importing Files / Using FeatureWorks Software

This chapter guides you through the import of a gasket and a company logo, and demonstrates the following:

- ❑ Importing an *IGES*[®] file
- ❑ Using *the FeatureWorks*[™] software to recognize features on the imported solid
- ❑ Importing a *DXF* file
- ❑ *Copying a sketch* from a drawing to use for a feature in a part
- ❑ Exporting a SolidWorks part document as an *STL* file

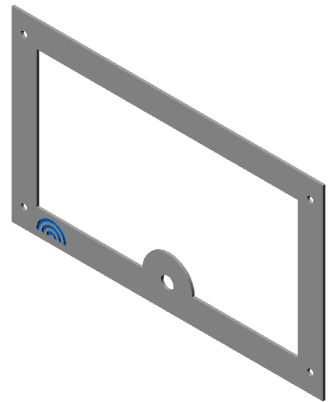

Importing an IGES File

You can import surfaces from IGES files and use them to create a base feature if the surfaces form a closed volume.

- 1 Click **File, Open**.

The **Open** dialog box appears.

- 2 In the **Files of type** list, click **IGES Files (*.igs, *.iges)**.

- 3 Click **Options** to set the import options.

- 4 Make sure **Knitting** and **Try forming solid(s)** are selected, then click **OK**.

When these two options are selected, the SolidWorks software attempts to knit the surfaces from an imported file into a solid model.

- 5 Browse to the path
\installation_directory\samples\tutorial, select
Gasket.igs, and click **Open**.

Once the SolidWorks software finishes knitting the surfaces into a base feature, the dialog box disappears and the imported body appears in the graphics area.

- 6 If a message appears asking if you want to proceed with feature recognition, click **No**.

Notice the new feature, **Imported1**, in the FeatureManager design tree. You cannot edit the sketches, dimensions, or features of an imported solid model.

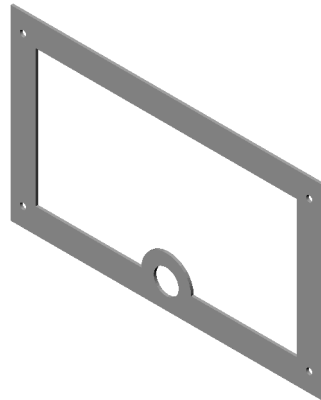

Recognizing Features using the FeatureWorks Software

The FeatureWorks software recognizes features on an imported solid body in a part document. Recognized features are the same as features that you create using the SolidWorks software. You can edit the definition of recognized features to change their parameters. For features that are based on sketches, you can edit the sketches of recognized features to change the geometry of the features.

NOTE: If you do not have the FeatureWorks software installed on your computer, please turn to **Importing a DXF File** on page 18-4. You can still complete the remainder of the exercise if you do not have the FeatureWorks software.

- 1 If **FeatureWorks** does not appear on the SolidWorks main menu bar, click **Tools**, **Add-Ins**, select **FeatureWorks**, and click **OK**.
- 2 Click **FeatureWorks Options**  on the toolbar, or click **FeatureWorks, Options**. Make sure **Overwrite existing part** and the **Basic features** check box are selected, then click **OK**.

Selecting the **Basic features** check box enables the FeatureWorks software to recognize extrusions and revolves during Automatic Feature Recognition.

- 3 Click **Recognize Features**  on the toolbar, or click **FeatureWorks, Recognize Features**.

The **Recognize Features - Interactive** dialog box appears.

- 4 Recognize a single feature.
 - a) Set the **Feature Type** to **Cut Extrude**.
 - b) Select the circular edge of the cut as shown.
 - c) Click **Recognize Feature**.

The selected edge is recognized as the sketch for a **Cut-Extrude** feature. The recognized feature disappears from the solid body. Any geometry not yet recognized still appears in the graphics area.

- 5 Click **Automatic** to perform Automatic Feature Recognition.

The FeatureWorks software attempts to recognize as many features as possible from the remaining geometry.

- 6 Click **Map Features** to accept the default feature recognition.

The **Imported1** feature is replaced by a **Base-Extrude** and a **Cut-Extrude1** feature in the FeatureManager design tree. The **Base-Extrude** feature is the result of the Automatic Feature Recognition. These new features are fully editable.

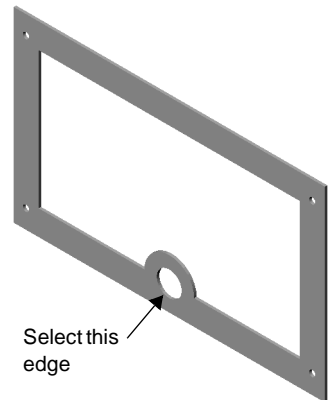

Editing the Sketch of a Feature

Now, you can change the size of one of the holes in the gasket.

- 1 Right-click **Cut-Extrude1** in the FeatureManager design tree and select **Edit Sketch**.
- 2 Add a **Concentric** relation between the sketched circle and the circular edge as shown.
- 3 Add a 10mm dimension to the sketched circle, then exit the sketch.
The hole changes size.
- 4 Save the part as **Gasket.sldprt**.

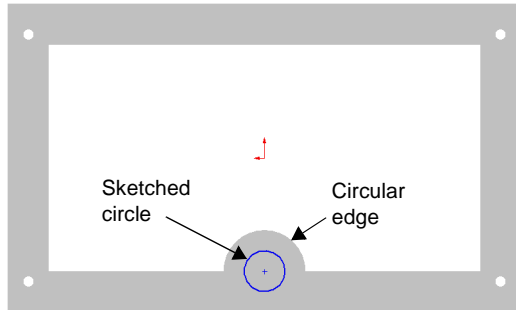

Importing a DXF File

You can import a DXF file to a drawing document. The DXF file that you import in this exercise contains the company logo for a fictitious company, Rainbow Corporation.

- 1 Click **File, Open**.
The **Open** dialog box appears.
- 2 In the **Files of type** list, click **Dxf Files (*.dxf)**.
- 3 Browse to the path `\installation_directory\samples\tutorial`, select **Rainbow.dxf**, and click **Open**.
The **DXF/DWG Import Wizard** starts.
The **DXF/DWG Import - Document Type** dialog box appears.
- 4 Click **Import to a new drawing**, then click **Next**.
The **DXF/DWG Import - Document Settings** dialog box appears.
- 5 Do the following:
 - a) Select the **Show preview** check box.
 - b) Select **A-Landscape** as the **Paper size**.
 - c) Click **Position**, then set **X** and **Y** to 0 (zero).
 - d) Under **Document template**, browse to the path `\installation_directory\lang\<your_language>` select **Draw.drwdot**, and click **Open**.
- 6 Click **Next**.
The **DXF/DWG Import - Drawing Layer Mapping** dialog box appears.
- 7 Click **Import all data to the sheet**, then click **Finish**.

A new drawing document is created containing the entities in the DXF file. The imported company logo consists of lines, arcs, and dimensions.

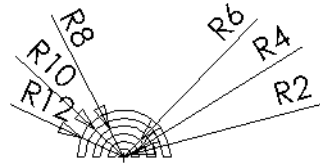

Prepare the Imported Entities for Copying

Before you copy imported DXF entities from a drawing to a sketch in a part, you must prepare the entities. The imported sketch entities are unconstrained; there are no relations between the entities. Also, the dimensions in the imported DXF file are not attached to any sketch entities.

- 1 Click **Tools, Relations, Constrain All**, then click **OK** in the message box.

The SolidWorks software adds all the apparent relations and reports the number of relations that are added.

- 2 Click **Display/Delete Relations**  or **Tools, Relations, Display/Delete**.

- 3 Using the **Next**  or **Previous**  buttons, view each relation.

Notice that the SolidWorks software added many **Coincident**, **Collinear**, and **Horizontal** relations.

- 4 Click **Close** to close the **Display/Delete Relations** dialog box.

- 5 Click **Tools, Dimensions, Attach Dimensions**, then click **OK** in the message box.

Each of the dimensions in the imported DXF file are attached to the appropriate arc.

- 6 Click **Rebuild** .

Copying and Pasting the Imported Entities

You can copy entities from a drawing to a sketch of a part. The software creates a new sketch in the part once you paste the entities.

- 1 Drag-select the entities on the drawing, including the dimensions.

- 2 Click **Copy**  or press **Ctrl+C**.

- 3 Click **Window, Gasket** to switch to the part.

- 4 Select the front face of the gasket, then click **Paste**  or press **Ctrl+V**.

A new sketch is automatically created in the part containing the company logo.

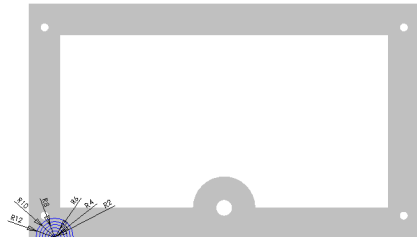

Special Topics

- 5 Right-click **Sketch3** and select **Edit Sketch**.

Notice that all of the dimensions and entities from the drawing are in the new sketch.

- 6 Add the 5mm and 20mm dimensions as shown to position the sketch entities.

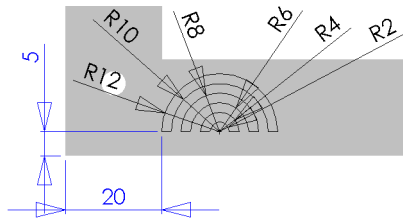

Extrude the Company Logo

- 1 With the sketch still open from the previous section, click **Extruded Cut**  or **Insert, Cut, Extrude**.

The **Cut-Extrude** PropertyManager appears.

- 2 Under **Direction 1**, do the following:

- Set **End Condition** to **Blind**
- Set **Depth**  to 1mm

- 3 Click **OK** .

Now, change the color of the new extrusion so it appears more easily.

- 4 Select **Cut-Extrude2** in the FeatureManager design tree.

- 5 Click **Edit Color**  on the Standard toolbar.

The **Edit Color** dialog box appears.

- 6 Click the desired color on the palette, then click **OK**.

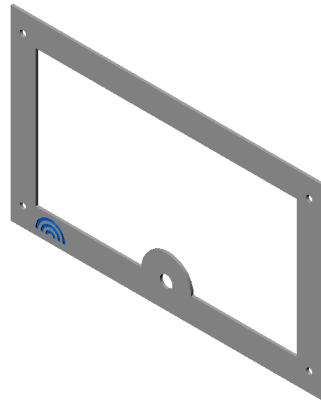

Exporting an STL File

You can save a SolidWorks part document as an STL file. STL format is intended for transfer to rapid prototyping machines.

- 1 Click **File, Save As**.

The **Save As** dialog box appears.

- 2 In the **Save as type** list, click **STL Files (*.stl)**, then click **Options** to set the export options.

The **STL Export Options** dialog box appears.

- 3 Make sure the **Quality** is set to **Fine** and the **Show STL info before file saving** check box is selected, then click **OK**.

TIP: You can experiment with the **Quality** settings to determine the best settings for your own rapid prototyping machines.

- 4 Click **Save** to save the file with the default name, **Gasket.stl**.

A message box appears displaying the number of **Triangles**, **File Size**, and **File Format**.

- 5 Click **Yes** to complete the save operation.

Learning to use PhotoWorks

This chapter teaches you how to use the PhotoWorks™ software to create photo-realistic images of SolidWorks models. This chapter covers the following topics:

- ❑ PhotoWorks fundamentals
- ❑ Using the PhotoWorksManager
- ❑ Rendering an image with the PhotoWorks Render Wizard
- ❑ Selecting and applying PhotoWorks materials
- ❑ Previewing and editing PhotoWorks materials
- ❑ Rendering a sub-image
- ❑ Saving and viewing image files
- ❑ Creating and managing PhotoWorks material archives
- ❑ Creating and applying decals with the PhotoWorks Decal Wizard
- ❑ Designing PhotoWorks scenery



Section 1: PhotoWorks Fundamentals

Before you begin, there are a few things you need to know about the PhotoWorks software.

- ❑ **PhotoWorks software creates realistic images directly from SolidWorks models.** The PhotoWorks software interacts with the 3D geometry that you create with SolidWorks software. All changes to SolidWorks models are accurately represented in PhotoWorks images.
- ❑ **PhotoWorks software is for use with 3D SolidWorks parts and assemblies.** It cannot be used with SolidWorks drawings.
- ❑ **PhotoWorks software is fully integrated with SolidWorks.** The PhotoWorks software is supplied as a SolidWorks dynamic link library (.dll) add-in. You access all the controls for the PhotoWorks rendering interface from the *PhotoWorks* item on the main SolidWorks menu bar, or from the PhotoWorks toolbar. This menu bar is displayed whenever a SolidWorks part or assembly document is open.
- ❑ **PhotoWorks materials give you control over the appearance of SolidWorks models.** *Materials* are used in the PhotoWorks software to specify model surface properties such as color, texture, reflectance, and transparency. Material selection and composition are performed using the PhotoWorks *material editor*. The PhotoWorks software is supplied with a number of *archives* of pre-defined materials, (metals, plastics, woods, stones, and so on), which can be attached to, and stored with, individual SolidWorks parts and faces. *Texture mapping* is also supported, enabling you to attach 2D textures such as scanned images and logos, to the surfaces of your models. You can also create your own material archives in which to organize your own collections of materials.
- ❑ **PhotoWorks scenes add photo-realism to your designs.** Each SolidWorks model is associated with a PhotoWorks *scene*, for which you can specify properties such as lighting, shadows, and backgrounds. Scene selection and composition are performed using the PhotoWorks *scene editor*. The PhotoWorks software is supplied with a number of archives of pre-defined scenes. You can also create your own scene archives. Once you are happy with the look of your scene, you can save it to an image file. You can then incorporate the image in design proposals, technical documentation, product presentations, and so on.

Section 2: The 40-Minute Running Start

This section guides you through your first rendering session with the PhotoWorks software.

- 1 If **PhotoWorks** does not appear on the SolidWorks main menu bar, click **Tools**, **Add-Ins**, select **PhotoWorks**, and click **OK**.
- 2 Click **Open**  on the Standard toolbar, and open the file:

`\installation directory\samples\tutorial\photoworks\candlestick\cstick.sldprt`

Notice that there is a **PhotoWorks Help** item available on the main **Help** menu, and that a PhotoWorks toolbar has been added to the SolidWorks window, beneath the Standard toolbar. Context-sensitive, online help is also available for most PhotoWorks features by clicking the **Help** button in the dialog box or by pressing the **F1** key.

- 3 Set view orientation to ***Trimetric**, then select the **Shaded** view mode from the **View** toolbar. Your screen should look like this:

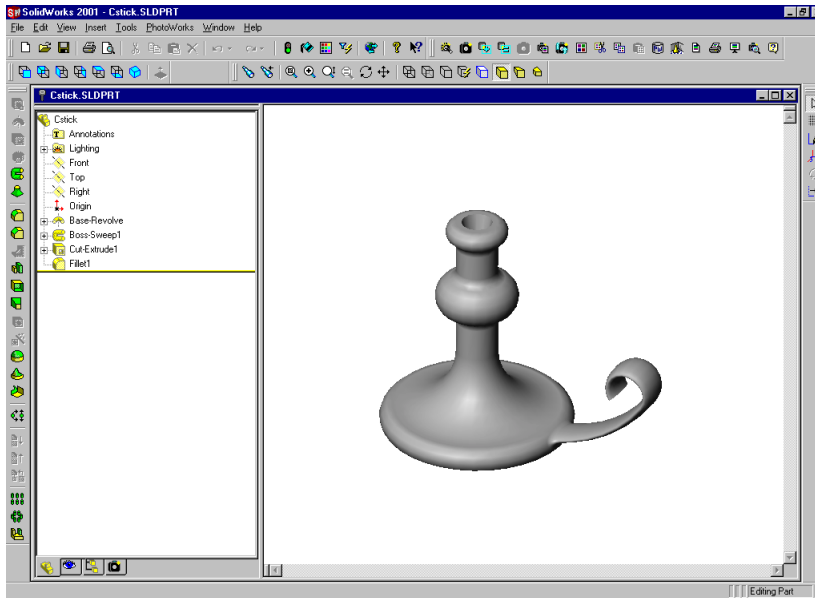

Checking the Options Settings

Before you begin, make sure that your SolidWorks settings match the ones used in this example so that your results will be the same.

- 1 Click **Tools, Options**, and select the **Document Properties** tab.
- 2 Under **Units**, in the **Linear units** section, make sure that **Millimeters** is selected and that **Decimal places** is set to 2.
- 3 Under **Image Quality**, make sure that **High Quality** is selected in the **Shaded** section.
- 4 Click **OK**.

Now set PhotoWorks options.

- 1 Click **Options**  on the PhotoWorks toolbar, or click **PhotoWorks, Options**.
- 2 On the **Render** tab, the PhotoWorks software provides options for trading image quality with rendering performance. Select these options if desired:
 - **Anti-aliasing** eliminates jagged silhouette edges. Rendering is slower, but images are smoother. For final image rendering, select this option.
 - **Overlay image** prevents the current image from being cleared before the next image is rendered. This option does not affect rendering speed.
- 3 On the **Materials** tab, the PhotoWorks software provides options for controlling the transfer of material properties between the SolidWorks and PhotoWorks software. By default, material properties such as color and reflectance are maintained separately in SolidWorks and PhotoWorks software. The options are:
 - **Overwrite SolidWorks properties on select/edit** updates SolidWorks material properties automatically when selecting or editing materials within PhotoWorks.
 - **Apply SolidWorks properties for render** causes the PhotoWorks software to use SolidWorks material properties during rendering.

For the purpose of this example, leave both boxes clear.

- 4 Click **OK**.

Using the PhotoWorksManager

The *PhotoWorksManager* is similar to the FeatureManager design tree in that it provides an outline view of the SolidWorks model.

The PhotoWorksManager indicates which items of geometry have which PhotoWorks materials and decals associated with them.









This makes it easy to:



- Understand the way in which material and decal inheritance works.
- Select and edit materials and decals associated with the model.
- Transfer materials and decals between components, features, and faces.

You can also customize the appearance of the PhotoWorksManager to suit your needs during a PhotoWorks session. For example, you can configure the PhotoWorksManager to show every feature and face in the model, or to show only those features or faces that have particular attributes associated with them, such as materials or decals.

- 1 Split the FeatureManager design tree.
- 2 Select **PhotoWorksManager**  in the FeatureManager design tree to display the PhotoWorksManager tab.

The top level of the tree shows two items:

- The part, indicated by the  **Cstick** icon. From here, you can edit the material and decal properties associated with the part by right-clicking the  **Cstick** icon and selecting from the **Material** or **Decals** shortcut menus.
- The current PhotoWorks scene, indicated by the  **Scene** icon. From here, you can edit the scene by double-clicking the  **Scene** icon (or right-clicking it and selecting **Edit**). You can also edit a particular scene property by clicking the **+** beside the  **Scene** icon, and then double-clicking the  **Lighting**,  **Foreground**,  **Background**, or  **Scenery** icons (or right-clicking an icon and selecting **Edit**).

When you apply a material or a decal to the part, or to a particular feature or face, the PhotoWorksManager is updated automatically with new icons to reflect these changes. You can access these properties again (for subsequent editing) by double-clicking on the appropriate  material or  decal icon within the PhotoWorksManager.

Rendering an Image

Rendering an image with the PhotoWorks software is straightforward.

- 1 Click **Render**  on the PhotoWorks toolbar, or click **PhotoWorks, Render**.



The PhotoWorks software produces a solid, smooth-shaded rendering of the candlestick, against a default background scene consisting of a reflective tread-plate ‘floor’ and cork-patterned ‘walls’.

The **PhotoWorks - Default Material** dialog is displayed, indicating that the part has been rendered with the default material, **Polished Plastic**. The default material can be applied to the model automatically for you, if you do not wish to create and apply a material yourself. (You can also set your own default material.)

- 2 Click **Yes** to apply this material to the model.

The **PhotoWorks - Default Scene** dialog is displayed, indicating that the part has been rendered with the default scene, **Shiny Tread Plate and Cork**. The default scene can be applied to the model automatically for you, if you do not want to select or create a default scene yourself. (You can also set your own default scene.)

- 3 Click **Yes** to apply this scene to the model.
- 4 Change the view orientation.

The view returns to the normal, SolidWorks, shaded view.

- 5 Click **Render**  or **PhotoWorks, Render** again.

Each time you change the view, you need to render the image again.

To abort a rendering, click **Stop** in the **PhotoWorks - Render** dialog box.

Using the PhotoWorks Render Wizard

The PhotoWorks *Render Wizard* guides you through the basic steps involved in creating a photo-realistic image. Key steps include the selection of PhotoWorks *material* and *scene* properties.

A material defines how the surface of a part reacts to light. Each material consists of properties that determine various aspects of its appearance, such as surface color and texture, reflectance, and transparency.

A scene consists of properties additional to those directly associated with the SolidWorks model. These include lighting, shadows, foreground and background effects, and scenery.

1 Click **Render Wizard**  on the PhotoWorks toolbar, or click **PhotoWorks, Render Wizard**.

2 After reading the **Welcome** note, click **Next** to learn about the PhotoWorks *material editor*.

The **Manager** tab on the **PhotoWorks - Material Editor** dialog box has two display panels:

- A *Material Archive* tree, which lists all the material archives currently available
- A *material selection* area, in which to view and select materials

3 Click the **Show me** buttons to learn how to select a material.

4 In the **Stock Procedural** material archive, click the **Metals** class to display the materials it contains.

5 Click the **Antique Brass** material to select it, then click **Apply**.

NOTE: You can also select and apply a material in one operation by double-clicking the image in the material selection area.

6 Click **Next** to learn about the PhotoWorks *scene editor*.

The **Manager** tab on the **PhotoWorks - Scene Editor** dialog box has two display panels:

- A *Scene Archive* tree, which lists all the scene archives currently available
- A *scene selection* area, in which to view and select scene templates

7 Click the **Show me** buttons to learn how to select a scene.

8 Click **Next** to proceed to the final dialog box of the Render Wizard, then click **Finish**.

The PhotoWorks software renders the candlestick with an antique brass finish.

Selecting a Material

Now add more realism to the candlestick by selecting a different material for it.

Notice that the PhotoWorksManager has been updated by the addition of an  **Antique Brass** material icon to indicate the material currently associated with the candlestick.

- 1 Double-click  **Antique Brass** (or right-click and select **Edit**).

Alternatively, you can right-click the  **Candlestick** icon in the PhotoWorksManager and select **Material, Edit**, or you can click **Materials**  on the PhotoWorks toolbar, or click **PhotoWorks, Materials**.

Notice that the icon representing the material currently associated with the part is highlighted in the material selection area on the **Manager** tab whenever you open the material editor.

- 2 Select the **Polished Brass** material.

The **Preview** window, to the right of the **PhotoWorks - Material Editor** dialog box, is updated to show how the part will appear when it is rendered.

- 3 Click **Apply**, then click **Close**.

Notice that the PhotoWorksManager has been updated with a  **Polished Brass** material icon, to indicate the change of material.

- 4 Click **Render**  or **PhotoWorks, Render**.



The candlestick is rendered with a polished brass appearance. Notice how the base of the candlestick reflects its stem and the surrounding background.

- 5 Change the view orientation, then render again.

Notice how the reflections change on the curved surfaces of the candlestick.

Previewing a Material







You can use the **Preview** window on the **PhotoWorks - Material Editor** dialog box to preview materials and material edits rapidly, before committing to a full-size render.

Various controls are provided to manipulate the behavior of the **Preview** window.



- 1 Double-click  **Polished Brass** in the PhotoWorksManager (or right-click and select **Edit**).

Now examine the **Preview** window.

In the **Rendering** section, you have the following options for rendering the preview:

- In **Automatic** mode , each time you change a material property, the preview is rendered again.
- In **Manual** mode , you can change as many properties as you want, then render the preview once to incorporate all the changes. To render the preview in **Manual** mode, click **Automatic** mode . Click again to return to **Manual** mode .
- In **Full** mode , the PhotoWorks software uses photo-realistic rendering for the preview.
- In **Interactive** mode , the PhotoWorks software uses OpenGL rendering for the preview.

NOTE: You can also use PhotoWorks OpenGL rendering in the active SolidWorks document window. Click **Interactive Rendering**  on the PhotoWorks toolbar, or click **PhotoWorks, Interactive Rendering**.

- In the **Display components** section, you can choose to display the **Model**, or you can choose a simpler geometric shape. Preview rendering is faster with a simpler shape that approximates that of the model, such as a **Cylinder**. For certain types of change, you may need to see the details on the model.
- Click **Zoom to Fit**  to display the part full size in the **Preview** window.
- Click **Zoom to Area**  to zoom in on a particular area of the **Preview** window by positioning the pointer over it, then clicking and dragging a bounding box to enclose the selected area.
- Click **Rotate View**  to rotate the part by clicking and dragging in the **Preview** window.
- You can also choose to disable various material properties temporarily, such as reflectance and transparency, to further accelerate preview rendering.



NOTE: The **PhotoWorks - Material Editor** dialog box is a *modeless* dialog. You can keep it open while selecting other SolidWorks geometry and reference objects.

Editing a Material

Now try editing the reflectance properties of the polished brass material that you applied previously to the candlestick.

- 1 Click the **Reflectance** tab on the **PhotoWorks - Material Editor** dialog box.

The reflectance of a material defines its ‘finish’, and determines how it behaves in the presence of light. Notice that the **Style** is set to **Conductor**. The PhotoWorks software supports several reflectance styles.

- 2 Change the **Style** to **Metal**.

Notice that the preview retains the brass color but is now rendered with a specular metallic appearance.

- 3 Change the **Style** to **Glass**.

- 4 Click **Apply**, then click **Close**.

- 5 Click **Render**  or **PhotoWorks, Render**.

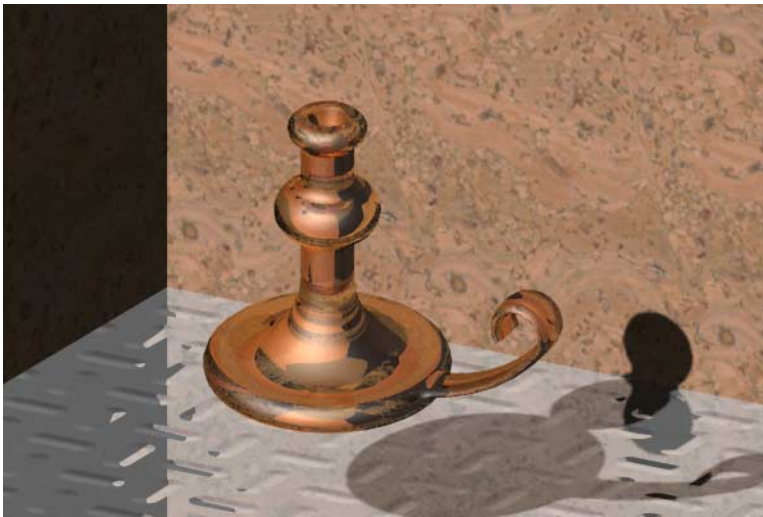

The candlestick is rendered with a realistic approximation of glass reflectance, including transparency, reflection, and refraction.

Rendering a Sub-image

You can use sub-image rendering to constrain the PhotoWorks software to render a selected area or selected geometry within the active SolidWorks document window.

- 1 Change the view orientation.
- 2 Click **Render Area**  on the PhotoWorks toolbar, or click **PhotoWorks, Render Area**.

- 3 Drag a window over the area to render.

The PhotoWorks software renders only the area you selected.

- 4 Now edit the material again:
 - a) Double-click  **Polished Brass** in the PhotoWorksManager (or right-click and select **Edit**).
 - b) On the **Reflectance** tab, set **Mirror** to 0.5, to make the surface of the material appear more reflective.
 - c) Click **Apply**, then click **Close**.

- 5 Click **Render Last**  on the PhotoWorks toolbar, or click **PhotoWorks, Render Last**.

The PhotoWorks software re-renders the sub-image that you selected previously. This is a useful facility for when you want to edit the properties of a single material but do not want to render the whole model. The last sub-image remains valid until you select a new sub-image.

- 6 Click **Boss-Sweep1** in the FeatureManager design tree.
- 7 Click **Render Selection**  on the PhotoWorks toolbar, or click **PhotoWorks, Render Selection**.



The PhotoWorks software renders a sub-image of the selected geometry.

- 8 Change the view orientation again, then click **Render Last**  or **PhotoWorks, Render Last**.

The PhotoWorks software re-renders the **Boss-Sweep1** feature. Again, this is a useful facility for when you want to ‘fine-tune’ the appearance of a particular feature, without having to render the whole model.

Saving an Image to File

You can save a PhotoWorks image to a file for use in design proposals, technical documentation, product presentations, and so on. The PhotoWorks software supports Bitmap (**.bmp**), TIFF (**.tif**), Targa (**.tga**), and JPEG (**.jpg**) formats, as well as PostScript (**.ps**) and the PhotoWorks image format (**.lwi**).

- 1 First, change the candlestick material once again:
 - a) Double-click  **Polished Brass** in the PhotoWorksManager (or right-click and select **Edit**).
 - b) Use the scroll bar in the material selection area to locate **Silver Plate**, then double-click it to select and apply the material.
- 2 Set view orientation to ***Trimetric**.
- 3 Click **Render Image to File**  on the PhotoWorks toolbar, or click **PhotoWorks, Render Image to File**, to display a **Save As** dialog box.

The PhotoWorks software suggests an image file name based on the name of the part, along with the extension appropriate to the selected image format. By default, the image will be stored in the same directory as the part.

- 4 (Optional.) Select a different file name, file type, or storage location for the image.
- 5 (Optional.) Set the **Image Size**, by specifying the **Width** and **Height**.

By default, the PhotoWorks software sets the resolution of the image in **Pixels**, according to the width and height of the active SolidWorks document window. You can specify the **Width** and **Height** of the image in **Centimeters** or **Inches** if you find these units more convenient. If you want the image to retain its original proportions when you alter the **Width** or **Height**, select the **Fixed aspect ratio** check box.

- 6 (Optional.) Click **Options** to set options appropriate to the selected image format.
- 7 (Optional.) Select the **Prompt when render complete** check box if you want the PhotoWorks software to notify you when the image has been rendered to file.
- 8 Click **Save**.

The PhotoWorks software renders the image to file.

Viewing an Image File

You can view previously saved images using the PhotoWorks *image viewer*. All the image formats available in the PhotoWorks software (except PostScript) are supported by this utility.

- 1 Click **View Image File**  on the PhotoWorks toolbar, or click **PhotoWorks, View Image File**.
- 2 Locate the image file that you saved from **Saving an Image to File** on page 19-12.

NOTE: Select the **Preview** check box on the file browser if you want to preview the image file before opening. This is useful if you have several image files.

- 3 Click **Open**.

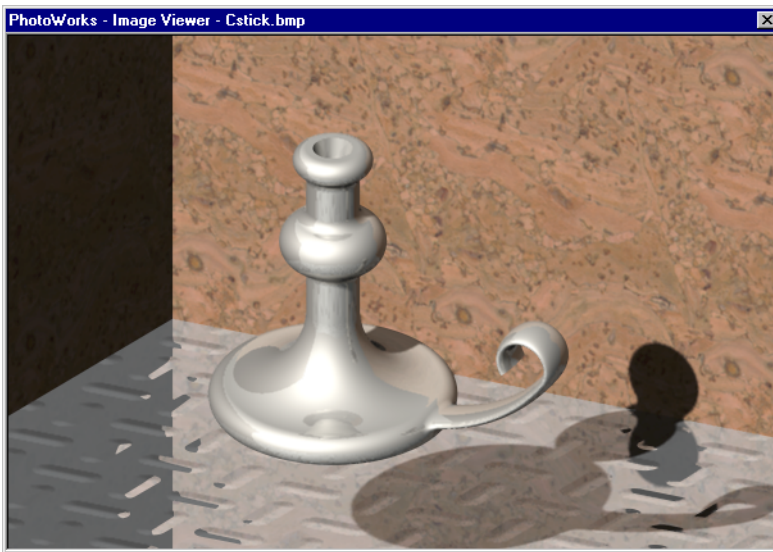

The PhotoWorks software loads the image file and displays it in a separate window. SolidWorks is disabled temporarily while viewing an image file

- 4 Close the **PhotoWorks - Image Viewer** window.
- 5 Save and close the part.

Section 3: Working with PhotoWorks Materials

The PhotoWorks software provides an intuitive and flexible interface to material selection and editing, enabling you quickly and easily to specify surface properties such as color, texture, reflectance, and transparency for your SolidWorks models. This section teaches you more about applying PhotoWorks materials to SolidWorks parts, features, and faces.

The PhotoWorks software is supplied with a number of archives of pre-defined materials. This section also demonstrates how to create and manage your own material archives, to help you to organize your own collections of materials.

Finally, this section shows how to link materials to an archive via *instancing*. This facility enables you to edit material properties across multiple items of geometry simultaneously.

- 1 Click **Open**  and open the file:

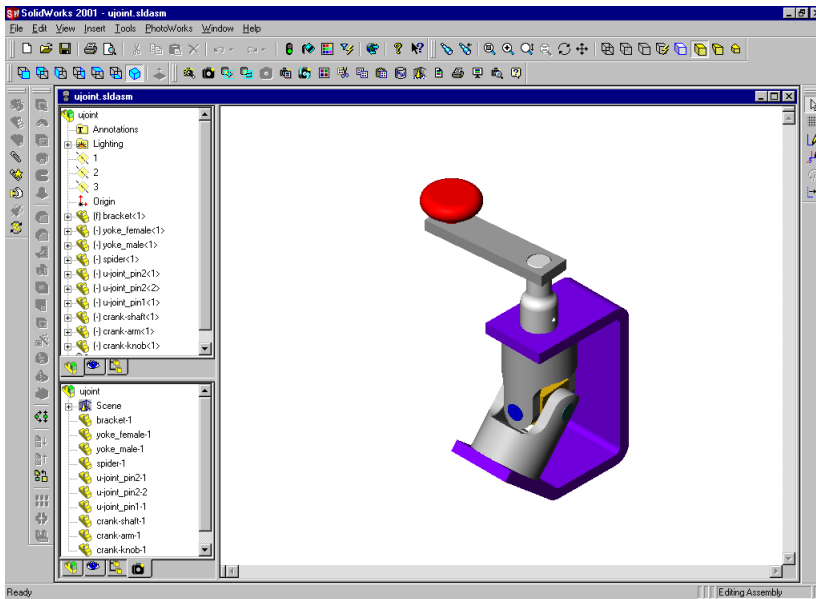

`\\installation directory\samples\tutorial\universal_joint\ujoint.sldasm`

- 2 Split the FeatureManager design tree.
- 3 Select the **PhotoWorksManager**  tab.
- 4 Set view orientation to ***Isometric**, and set view mode to **Shaded**. Your screen should look like this:



Adding a Material to a Part Within an Assembly

Start by creating a knurled plastic finish for the knob on the crank handle.



- 1 Click **crank-knob** in the FeatureManager design tree.
- 2 Click **Edit Part**  on the Assembly toolbar.
- 3 Click **Materials**  on the PhotoWorks toolbar, or click **PhotoWorks, Materials**.
- 4 Double-click the **Stock Procedural 3** archive (or click the **+** beside its name) to expand it and display the material classes it contains.
- 5 Click the **Plastic: Resin** class to display the materials it contains.
- 6 Select the **Shiny Resin Cyan** material.
- 7 Switch to the **Displacement** tab.

The displacement property of a material defines how rough or ‘bumpy’ it is. Notice that the **Style** is set to **Rough**. The PhotoWorks software supports several displacement styles.

- 8 Change the **Style** to **Knurled**.
- 9 Set **Scale** to 0.25, to make the knurls slightly smaller.
- 10 Click **Apply**, then click **Close**.

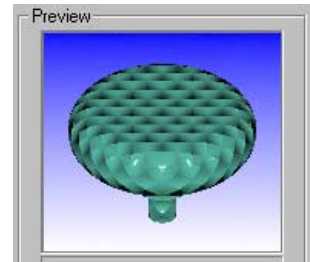
Notice that the **crank-knob** part in the PhotoWorksManager has been updated by the addition of a  **(p) Shiny Resin Cyan** material icon. The **(p)** indicates that the material is associated with a base part.



- 11 Click **Edit Part**  again.
- 12 Click **Render**  on the PhotoWorks toolbar, or click **PhotoWorks, Render**.

The PhotoWorks software renders the assembly, the crank-knob now having a knurled plastic appearance.

Using Interactive Rendering to Preview Material Edits

You can use PhotoWorks *interactive rendering* to preview the effects of editing a material.

In this mode, the PhotoWorks software uses OpenGL rendering in the active SolidWorks document window. Although interactive rendering does not support all the advanced effects available within the PhotoWorks software, it does provide for rapid previewing of material edits.

1 Click **Interactive Rendering**  on the PhotoWorks toolbar, or click **PhotoWorks, Interactive Rendering**.

2 Click **bracket** in the FeatureManager design tree.

3 Click **Edit Part** .

4 Click **Materials**  on the PhotoWorks toolbar, or click **PhotoWorks, Materials**.

5 Move the **PhotoWorks - Material Editor** dialog box so that it does not obscure the SolidWorks window.

6 Expand the **Stock Procedural** material archive, click the **Metals** class, then click the **Steel** material to select it.

The **Preview** window is updated to show how the part will appear when it is rendered.

7 Click **Apply**.

The PhotoWorks software updates the main window to show the application of the material.

8 In the material selection area, click **Stainless Steel**, then click **Apply**.

The PhotoWorks software updates the main window to show the change of material.

9 Expand the **Metal Textures** archive, click **Brushed**, then double-click **Galvanized** to select and apply it.

Notice that the **bracket** feature in the PhotoWorksManager has been updated by the addition of a  (**p**) **Galvanized** material icon.

10 Click **Render**  or **PhotoWorks, Render**.

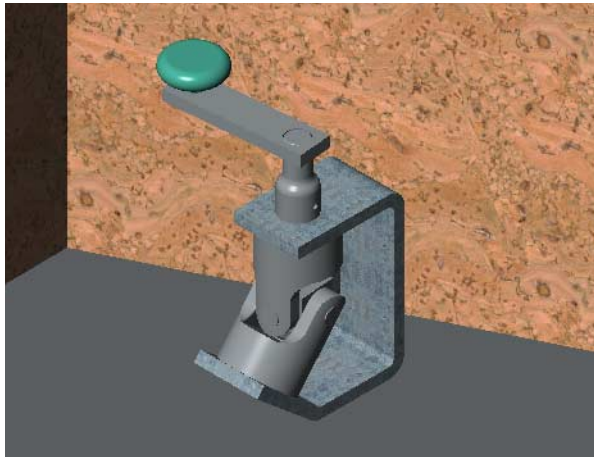











Adding Materials to Individual Features and Faces

You can use the PhotoWorks material editor to apply different materials to individual features and faces. You can also use the PhotoWorksManager to cut, copy, and paste materials between selected features and faces.

- 1 Hold down **Ctrl** and select **Boss-Extrude1** and **Fillet1** of the bracket in the FeatureManager design tree.
- 2 Click **Materials**  on the PhotoWorks toolbar, or click **PhotoWorks, Materials**.



NOTE: When you edit the material on selected features or faces, the **Preview** window displays the selected geometry only, rather than the whole part or assembly.

- 3 Expand the **Stock Procedural** archive, click **Metals**, then locate and double-click **Machined Aluminum** to select and apply it.
 Notice that the **Boss-Extrude1** and **Fillet1** features in the PhotoWorksManager have been updated by the addition of  **Machined Aluminum** material icons.
- 4 Now edit the material associated with **Boss-Extrude1**, then copy and paste the change to **Fillet1**, via the PhotoWorksManager:
 - a) Double-click the  **Machined Aluminum** icon beneath **Boss-Extrude1** in the PhotoWorksManager.
 - b) Locate and double-click **Chrome Plate** to select and apply it.
 - c) Right-click  **Chrome Plate** in the PhotoWorksManager and select **Copy**.
 - d) Right-click the  **Machined Aluminum** icon beneath **Fillet1** in the PhotoWorksManager and select **Paste**.
- 5 Now edit the material on a single face:
 - a) Select the flat face on the top of the bracket.
 - b) Click **Materials**  on the PhotoWorks toolbar, or click **PhotoWorks, Materials**.
 - c) Expand the **Metal Textures** archive, click **Brushed**, then double-click **Brushed 1** to select and apply it.
 Notice that the **Shell1** feature in the PhotoWorksManager has been updated by the addition of a  **<Face>** icon, with an associated  **Brushed 1** material icon.
- 6 Now copy the **Brushed 1** material and paste it onto another face:
 - a) Right-click the  **Brushed 1** icon and select **Copy**.
 - b) Select another face of the bracket.
 - c) Click **Paste Material**  on the PhotoWorks toolbar, or click **PhotoWorks, Paste Material**.
- 7 Click **Edit Part**  again.
- 8 Click **Render**  or **PhotoWorks, Render**.
- 9 Save the assembly.

Creating a Material Archive

With the PhotoWorks Material Manager you can create your own material archives.

You can archive both procedurally defined (solid) and texture-mapped (wrapped) materials, and you are free to organize the contents of each archive to suit your needs. For example, you may want to create material classes that classify materials according to their inherent properties (metal, plastic, stone, fabric, and so on). Alternatively, you may want to store all the materials that relate to a particular project or model in a class of their own.

- 1 Click **Materials**  on the PhotoWorks toolbar, or click **PhotoWorks, Materials**.
- 2 Click **Create Archive**  to display the **Create Archive** dialog box.
- 3 Type **My Materials** in the **File name** box, choose the location of the **.pma** file in which to store the archive, then click **Save**.

NOTE: By default, the PhotoWorks software uses the root directory on your drive to store your material archives. You may want to create a new directory in which to store material archives.

The PhotoWorks software appends a new material archive, **My Materials**, containing an empty **Untitled** material class to the Material Archive tree.

- 4 Click-pause-click **Untitled**, and rename it to **Universal Joint**.

The PhotoWorks software updates the symbol denoting the archive  to indicate that the class has been renamed.

- 5 Click the **My Materials** archive to select it, then click **Save Archive** .
- 6 Click **Close**.

Archiving a Procedurally Defined Material

Although it is not possible to edit the pre-defined material archives supplied with the PhotoWorks software, it is possible to add a copy of any pre-defined material to a material archive of your own. You can then edit the properties of your copy of the material to suit the needs of a particular project or model.

- 1 Click **Materials**  on the PhotoWorks toolbar, or click **PhotoWorks, Materials**.
- 2 Expand the **My Materials** archive.
- 3 Now expand the **Stock Procedural** archive, then click **Metals**.
- 4 Drag the **Polished Brass** material and drop it on the **Universal Joint** class when the class is highlighted.

The PhotoWorks software appends a copy of the **Polished Brass** material to the **Universal Joint** class.



- 5 Click-pause-click **Polished Brass**, and rename it to **Yoke**.
- 6 Click the **My Materials** archive to select it, then click **Save Archive** .
- 7 Click **Close**.

The PhotoWorks software notifies you that the current material selection has changed, and asks whether you want to apply this material.

- 8 Click **No**. (You will apply this material, and edit its definition, later in this tutorial.)

Archiving a Texture-Mapped Material

You can archive your own texture-mapped materials. For example, these may include scanned bitmaps of paint swatches, metal finishes, decals, labels, and company logos.

- 1 Click **Materials**  on the PhotoWorks toolbar, or click **PhotoWorks, Materials**.
- 2 Expand the **My Materials** archive, and click the **Universal Joint** class.
- 3 Click **Create Material (from Image File) in Archive**  to display the **PhotoWorks – Add Texture Materials** dialog box.
- 4 Locate the file:

`\installation directory\samples\tutorial\photoworks\textures\tex_tile.bmp`

- 5 Click **Add**, then click **Close**.

The PhotoWorks software appends a new texture-mapped material to the class, based on the image file. The material is given the image filename, minus the three-letter filename extension.

- 6 Click the **My Materials** archive to select it, then click **Save Archive** .
- 7 Click **Close**.

The PhotoWorks software notifies you that the current material selection has changed, and asks whether you want to apply this material.

- 8 Click **No**.
- 9 Close the assembly.

Linking Materials to an Archive via Instancing

You can use *instancing* to apply identical copies of any PhotoWorks material to multiple items of SolidWorks geometry. All instances of a given material share the same material definition, which is recorded in the material archive to which they are linked.

In this exercise, you apply the **Yoke** material that you created previously to two separate parts within the Universal Joint assembly.

- 1 Open the file:

`\installation directory\samples\tutorial\universal_joint\yoke_male.sldprt`

- 2 Click **Materials**  on the PhotoWorks toolbar, or click **PhotoWorks, Materials**.
- 3 Expand the **My Materials** material archive, click the **Universal Joint** class, then click the **Yoke** material to select it.
- 4 (Optional.) Press **F3**.

The PhotoWorks software re-renders the thumbnail image in the archive to match the image displayed in the **Preview** window.

- 5 Select the **Link to Archive** check box.

The PhotoWorks software notifies you that instancing the material will apply the properties from the shared material definition in the linked material archive.

- 6 Click **Yes** to proceed with the instanced material.
- 7 Click **Apply**, then click **Close**.
- 8 Save the part, then close it.
- 9 Open the file:

`\installation directory\samples\tutorial\universal_joint\yoke_female.sldprt`

- 10 Repeat steps 2 through 8, above.

Both the **yoke_male** and **yoke_female** parts now share identical instances of the **Yoke** material.

Editing a Shared Material Instance Definition

Any edits that you make to a shared material instance definition are applied automatically to all instances of the material. This feature enables you to alter material properties across multiple items of geometry simultaneously.

Try editing the definition of the **Yoke** material that you applied in the previous exercise.

- 1 Open the file:

`\installation_directory\samples\tutorial\universal_joint\ujoint.sldasm`

- 2 Click **Render**  or **PhotoWorks, Render**.

Notice that the **yoke_male** and **yoke_female** parts are rendered with the polished brass **Yoke** material that you created previously.

- 3 Click **yoke_male** in the FeatureManager design tree.

- 4 Click **Edit Part**  on the Assembly toolbar.

- 5 Click **Materials**  on the PhotoWorks toolbar, or click **PhotoWorks, Materials**.

- 6 In the **Apply to** list, select **Archive**.

- 7 Click the **Color** tab.

- 8 Under **Colors**, click **Edit**, select a color from the palette, then click **OK**.

- 9 Click **Apply**.

- 10 Click **Yes** to update the existing shared material definition.

- 11 Click **Close**.

- 12 Click **Edit Part**  again.

- 13 Click **Render**  or **PhotoWorks, Render**.

Notice that the appearance of the **Yoke** material has changed on both the **yoke_male** and **yoke_female** parts.

- 14 Save and close the assembly.



Section 4: Working with PhotoWorks Decals

This section shows you how to use the PhotoWorks software to attach custom labels or artwork (such as company logos or part numbers) to SolidWorks models.

The PhotoWorks *Decal Wizard* guides you through the steps involved in creating and adding a decal to a SolidWorks model.

Once you have added a decal, you can control its size and position, and overlay multiple decals, in any order, over any material type, including texture-mapped materials, using the PhotoWorks *decal editor*.

- 1 Open the file:

\installation directory\samples\tutorial\photoworks\housing\housing.sldprt

- 2 Split the FeatureManager design tree.

- 3 Select the **PhotoWorksManager**  tab. Your screen should look like this:

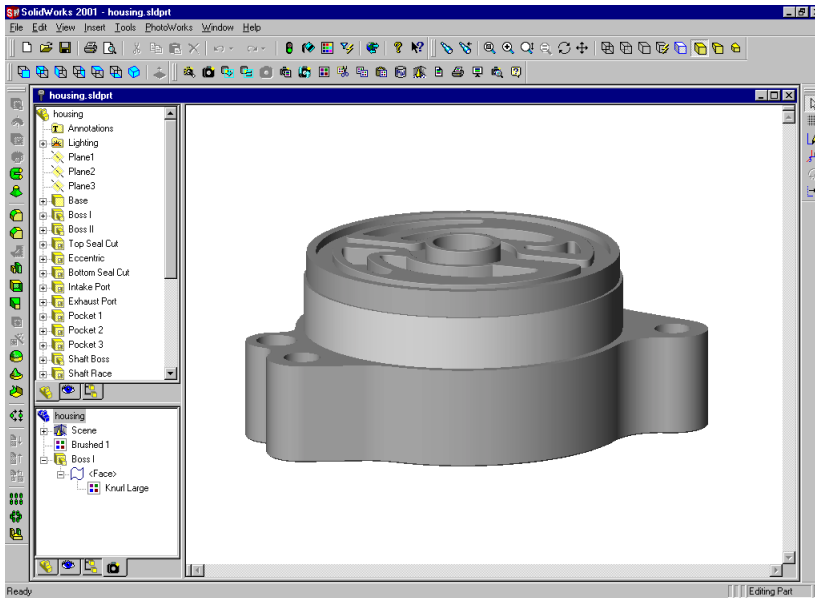

Adding a Decal to a Face

Now attach a decal representing a part number.

- 1 Select the large curved face on the **Base**.
- 2 Click **Decals**  on the PhotoWorks toolbar, or click **PhotoWorks, Decals**.

The **PhotoWorks - Decal Editor** dialog box is displayed. It includes:

- A *Decal Manager* tree, which lists all decals attached to the current part, feature, or face.
- A *display* area, in which to view the components of individual decals.

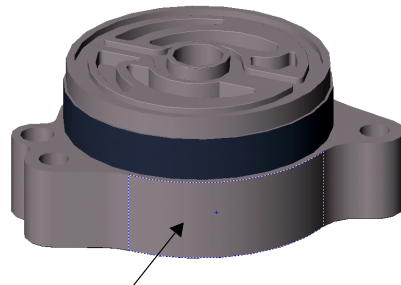

Select this face

Notice that **Create new decal with wizard** is selected.

- 3 Click **Create New Decal** .

The **PhotoWorks - Decal Wizard** is displayed.

- 4 After reading the **Welcome** note, click **Next** to select a decal image.
- 5 Click **Browse**, then locate and open the file:

`\installation directory\samples\tutorial\photoworks\decals\pw_image.bmp`

The image file contains the decal artwork – in this case, a simple part number.

- 6 Click **Next** to create a decal mask.
- 7 Select **From file**, then click **Next**.
- 8 Browse to the file:

`\installation directory\samples\tutorial\photoworks\decals\pw_mask.bmp`

- 9 Click **Next** to view the complete decal, consisting of the image combined with the mask.
- 10 Click **Next** through to the **Finished!** dialog box of the wizard, then click **Finish**.

The PhotoWorks software adds the new decal to the Decal Manager tree, giving it the name **Decal1**. The PhotoWorks software displays the components of the decal in the display area on the decal **Manager** tab. Also, **Image**, **Mask**, and **Mapping** tabs are added to the **PhotoWorks - Decal Editor** dialog box.

Adjusting a Decal on a Face

Now use the PhotoWorks decal editor to fine-tune the scale and orientation of the decal on the face.

- 1 With **Decal1** still selected in the Decal Manager tree, click the **Mapping** tab.

Notice that the PhotoWorks software has created a **Cylindrical** mapping for the decal, with reference to the **Selected face**. However, the scale and orientation of the decal require some adjustment to position it correctly.

- 2 Under **Scaling**, drag the **Around axis** slider to a position halfway between **Small** and **Large**.
- 3 Set **Along axis** to 14.00mm.
- 4 Under **Orientation**, set **Rotation about axis** to 85°.

The **Preview** window shows the decal correctly sized and centered on the face.

- 5 Click **Close**.

The PhotoWorks software notifies you that the decal has changed, and asks whether you want to apply the change.

- 6 Click **Yes**.

Notice that the PhotoWorksManager has been updated by the addition of a  **Decal1** decal icon, associated with the selected face.

- 7 Click **Render**  on the PhotoWorks toolbar, or click **PhotoWorks, Render**.



The PhotoWorks software scales the decal and offsets it to the specified position on the face.

Section 5: Working with PhotoWorks Scenes

Composing a scene can improve visual realism by giving your model a more solid, 3D appearance. Rather than leaving the model floating in space, you can use shadows to anchor it against a simple geometric backdrop. You can apply PhotoWorks materials to the backdrop for added realism.

- 1 Set view orientation to ***Top**, and rotate the part to approximately the orientation shown.
- 2 Click **Scene**  on the PhotoWorks toolbar, or click **PhotoWorks, Scene**.

The **PhotoWorks - Scene Editor** dialog box is displayed. It includes a scene **Manager** tab, from which to access scene archives, plus separate tabs for specific scene properties, and a **Preview** window with which to preview edits to these properties before rendering.

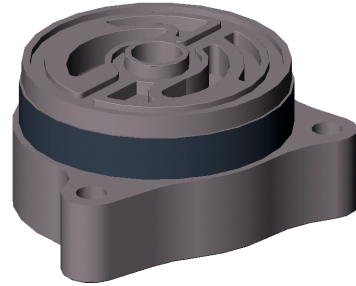

The scene **Manager** tab has two display panels:

- A *Scene Archive* tree, which lists all the scene archives currently available
- A *scene selection* area, in which to view and select scene templates

Notice that the icon representing the scene currently associated with the part – in this example, the **Default** scene in the **Basic** class of the **Stock Combinations** archive – is highlighted in the scene selection area on the **Manager** tab whenever you open the scene editor.

- 3 Click the **Lighting** tab.
- 4 Select the **Display shadows** check box.

The PhotoWorks software generates shadows for all SolidWorks directional lights, point lights, and spotlights in the scene.

NOTE: You can also specify shadow properties for individual SolidWorks lights, using the **PhotoWorks properties** on the appropriate SolidWorks **Light properties** dialog boxes.

- 5 In the **Display components** section of the **Preview** window, select the **Shadows** check box.

Notice how the **Preview** window shows the raised boss casting a shadow onto the base of the housing. Internal self-shadowing of the part is also visible.



Adding an Image Background

Areas of the image not covered by parts of the SolidWorks model are known as *image background*. You can fill these areas with various patterns or images, thereby adding further visual interest and appeal to your PhotoWorks images.

- 1 Click the **Background** tab on the **PhotoWorks - Scene Editor** dialog box.
Notice that the **Style** is set to **Graduated**. The PhotoWorks software supports several background styles.
- 2 Under **Parameters**, make sure that **Top Color** is selected, then click **Edit**.
- 3 Select a color from the palette, then click **OK**.
The **Preview** window is updated to show the change.
- 4 Modify the **Bottom Color**, if desired, observing the effect in the **Preview** window.
- 5 Now change the **Style** to **Clouds**.
- 6 Under **Parameters**, make sure that **Scale** is selected, then set **Number** to 2.
- 7 Modify the **Sky Color**, **Cloud Color**, and **Detail** parameters, if desired, observing the effect in the **Preview** window.

Other background options include scaled or tiled images, or plain colors.

The **PhotoWorks - Scene Editor** dialog box also includes a **Foreground** tab, from which you can select various styles of attenuation, to simulate atmospheric phenomena, such as fog and depth-cueing.

- 8 Click **OK**.
- 9 Click **Render**  on the PhotoWorks toolbar, or click **PhotoWorks, Render**.



Creating Background Scenery

The visual effectiveness of your presentation can be improved still further by setting the part against a geometric backdrop, rather than simply leaving it suspended in space.

With the PhotoWorks software, you can create simple background scenery consisting of a horizontal *base* plane and vertical *sides* surrounding the part. You can control the size and position of the scenery relative to the part, and select materials for the base and sides.

The scenery dimensions are calculated from the bounding box of the SolidWorks model. The scenery will never obscure the part. Only those planes visible behind the part will be displayed. Any reflective materials attached to the part will pick up and reflect color and texture from the background scenery.

- 1 Click **Scene**  or **PhotoWorks, Scene**, then click the **Scenery** tab.
- 2 Under **Base**, do the following:
 - a) Select the **Display** check box.

Notice that the default material, **Polished Plastic**, has been selected for the base.
 - b) Click **Edit**.

The **PhotoWorks - Material Editor** dialog box appears.
 - c) Expand the **Stone Textures** material archive, click the **Stone** class, then click the **Pink Marble** material to select it.
 - d) Click the **Mapping** tab.
 - e) Under **Scaling**, set both **Width** and **Height** to 65.00mm.
 - f) Click **OK**.
- 3 Under **Sides**, do the following:
 - a) Select the **Display** check box.

Notice that the default material, **Polished Plastic**, has been selected for the sides.
 - b) Click **Edit**.

The **PhotoWorks - Material Editor** dialog box appears.
 - c) Expand the **Wood Textures** material archive, click the **Wood** class, then click the **Mahogany** material to select it.
 - d) Click the **Mapping** tab.
 - e) Under **Scaling**, set both **Width** and **Height** to 50.00mm.
 - f) Click **OK**.
- 4 Under **Base size**, set both **Base width** and **Base height** to 125.00mm, to reduce the size of the base relative to the model.
- 5 Set **Base offset** to -25.00mm, to move the base closer to the model.
- 6 Set **Sides height** to 75.00mm.
- 7 Click **OK**.
- 8 Click **Render**  or **PhotoWorks, Render**.

SolidWorks Animator

In this chapter, you create animations and animation files of the claw model using SolidWorks Animator tools. This chapter discusses the following topics:

- Viewing the SolidWorks AnimationManager *tab*
- Animating a *rotation* with the Animation Wizard
- Animating an *exploded* view
- Scheduling* motion
- Animating a *collapsed* view
- Creating a *motion path*
- Recording* an animation
- Creating an animation file from *screen captures*

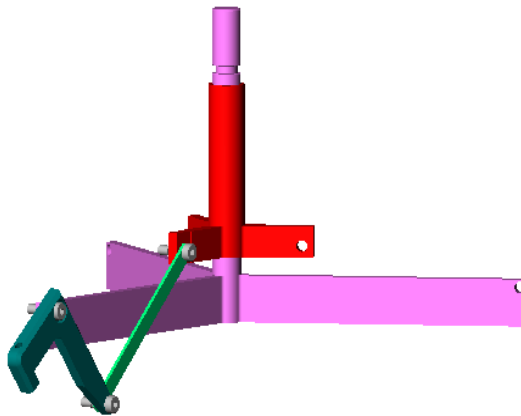

Getting Started with SolidWorks Animator

SolidWorks Animator is an add-in product, and it has its own AnimationManager tab.

- 1 Click **Open**  and open **Claw-Mechanism.sldasm**, found in the directory `\installation directory\samples\tutorial\animator`.
- 2 If **Animator** does not appear on the SolidWorks main menu bar, click **Tools, Add-Ins**.
The **Add-ins** dialog box appears.
- 3 Select **SolidWorks Animator** and click **OK**.



The following Animator tools are now available:

- The Animator menu appears in the menu bar.
- A **SolidWorks Animator Help Topics** item appears in the Help menu.
- The Animator Controller toolbar appears above the graphics area.



- 4 Click the AnimationManager tab  at the bottom of the left pane.

The AnimationManager tab is displayed when SolidWorks Animator is available. The AnimationManager display includes two sections. Each section lists the assembly components in a different manner.

- Viewpoint  - in the chronological order of the assembly creation
- Schedule  - in the chronological order of the animation

Items (motion paths) are added to Schedule as you generate animations.

Animating a Rotation with the Animation Wizard

The Animation Wizard helps you animate a rotation of the model through 360 degrees.

To create a rotation animation:

- 1 Click **Animation Wizard**  on the Animation Controller toolbar or **Animator, Animation Wizard**.
- 2 On the **Select an Animation Type** screen, select **Rotate model**, then click **Next**.
- 3 On the **Select an Axis of Rotation** screen, select the following.
 - **Axis of rotation** - Y axis
 - **Number of rotations** - 1
 - **Direction** - Clockwise

NOTE: The axes of rotation are as follows:

X - around the horizontal screen axis

Y - around the vertical screen axis

Z - around the screen axis pointing out of the screen

- 4 Click **Next**.
- 5 On the **Animation Control Options** screen, select the following.
 - **Duration (seconds)** - 10
 - **Start Time (seconds)** - 0
 - **At the close of the AnimationWizard** - Play animation

NOTE: The setting for **Duration** is the time of replay from an **.avi** file, which may vary from the play time in SolidWorks.

- 6 Click **Finish**.
- The model rotates 360 degrees.

Animating an Exploded View

The assembly already contains an exploded configuration. You can animate this exploded view using the Animation Wizard. You add the **Explode** animation at the end of the **Rotate** animation.

To animate an exploded view:

- 1 Click **Animation Wizard**  on the Animation Controller toolbar or **Animator, Animation Wizard**.
- 2 On the **Select an Animation Type** screen, select **Explode**, then click **Next**.
- 3 On the **Animation Control Options** screen, select the following.
 - **Duration (seconds)** - 10
 - **Start Time (seconds)** - 10
 - **At the close of the AnimationWizard** - Play animation

NOTE: Since the **Rotate** path begins at 0 and ends at 10 seconds, you set the **Explode** animation to begin (**Start Time**) at 10 seconds, after the rotation is completed.

In the AnimationManager Schedule section, note that only one motion path is created for **Rotate**. For **Explode**, each component has a separate path, and each path has the same start time, as set in **Start Time**.

- 4 Click **Finish**.

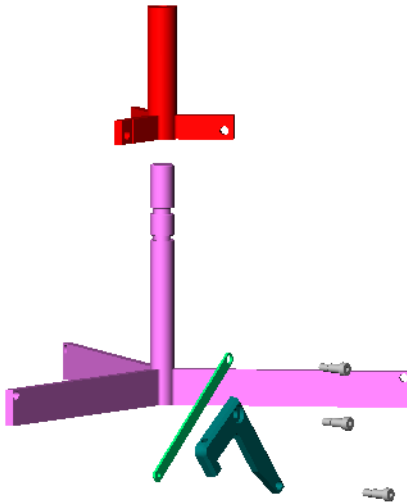

The model rotates 360 degrees, then explodes the view.



Scheduling Motion

You can edit the Schedule motion paths manually and set the scheduled times so that the components explode one at a time.

To schedule motion manually:

- 1 If necessary, click the AnimationManager tab , and click the  beside **Schedule** to expand the motion path schedules.

At the end of each Schedule line, the starting and ending time of the motion appears in parentheses. Notice that all the **Explode** paths start and end at the same time. You want to schedule the parts individually so that they move one at a time to simulate a disassembly process: first the pins, then the claw, the rod, and the collar.

- 2 Select **Pin-2 Explode**, then click **Edit Path**  on the Animation toolbar.

- or -

Right-click **Pin-2 Explode** and select **Edit Path**.

The **Edit Path** dialog box appears.

- 3 In the **Change Timing** section, change **Start time (sec)** to 20, then click **OK**.

Pin-2 Explode appears at the bottom of the list with the timing (20.00, 30.00) showing that Pin-2 starts moving at 20 seconds and stops at 30 seconds.

- 4 Repeat steps 3 and 4 for the other parts except **Pin-1 Explode**. Leave **Duration** at 10 for all the parts. Set the following start times:

Pin-3 Explode	30
Claw-1 Explode	40
Con-Rod-1 Explode	50
Collar-1 Explode	60





The Explode components appear in the Schedule list in chronological order.

- 5 Click **Play**  or **Animator, Animation, Play**.

The model rotates 360 degrees, then explodes one part at a time.

Playing the Animation

You can move through the animation using the Animator tools as follows:

Action	Result
Click Play  or Animator, Animation, Play	Plays the animation from beginning to end
Click First  or Animator, Animation, First	Moves to the beginning of the animation
Click Last  or Animator, Animation, Last	Moves to the end of the animation
Click Previous Frame  or Animator, Animation, Previous Frame	Single steps backwards from the end of the animation
Click Next Frame  or Animator, Animation, Next Frame	Single steps forward from the beginning of the animation

Animating a Collapsed View

Animating a collapsed view is similar to animating an exploded view.

To animate a collapsed view:



- 1 Click **Animation Wizard**  or **Animator, Animation Wizard**.
- 2 On the **Select an Animation Type** screen, select **Collapse**, then click **Next**.
- 3 On the **Animation Control Options** screen, select the following.
 - **Duration (seconds)** - 10
 - **Start time (seconds)** - 70
 - **At the close of the AnimationWizard** - Play Animation
- 4 Click **Finish**.

The model rotates 360 degrees, explodes one part at a time, then collapses.

Creating a Motion Path

You use the **Move Component** tool on the Assembly toolbar to specify a motion path for animation.

To create a motion path:

- 1 Select **Collar-1** in either AnimationManager, FeatureManager, or the graphics area.
- 2 Click **Create Path**  or **Animator, Create Path**.
The **Create Path** dialog box appears.
- 3 Click **Add Path Point** to set the current position as the initial position of the collar.
- 4 Leave the dialog box open. On the Assembly toolbar, click **Move Component** .
- 5 In the graphics area, drag the collar up to a new position.
- 6 In the dialog box, click **Add Path Point** to set the current position on the motion path.
- 7 Select the **Repeat initial path point as final path point** check box so the collar returns to the starting position at the end of the motion path.
- 8 Set the **Start time (sec)** to 70 to place the motion path at the end of the previous animation, then click **Done**.

A warning message appears indicating that two or more paths are overlapping. By setting the starting time to 70, the new motion path overlaps the **Collar-1 Collapse** motion path.

- 9 Click **OK** and click **Move Component**  to display AnimationManager.
Note the red exclamation points  beside all instances of **Collar-1** in AnimationManager.

To fix the overlapping paths:

- 1 Select **Collar-1-3**, then click **Edit Path**  on the Animation toolbar.
- or -
Right-click **Collar-1-3** and select **Edit Path**.
The **Edit Path** dialog box appears.
- 2 In the **Change Timing** section, change **Start time (sec)** to 80, then click **OK**.
The warning exclamation points disappear.

To play the animation:

Click **Play**  or **Animator, Animation, Play**. The model rotates, explodes, collapses, and finally the collar moves up and back down.

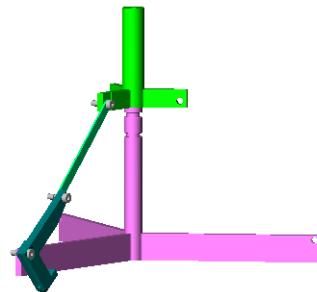

Recording an Animation

You can record an existing animation to a file of type **.avi** that you can play later.

To record an existing animation:

- 1 Click **Record Animation**  or **Animator, Record Animation**.

The **Save Animation to File** dialog box appears.

- 2 Set **Frames per second** to **5**, and click **Save**.
- 3 In the **Video Compression** dialog box, click **OK**.

The animation plays as the recording occurs, which takes a few minutes.



To replay the animation from the .avi file:

- 1 In Microsoft Explorer, find **Claw-Mechanism.avi** in the same directory as the model.
- 2 Double-click the file name to play the animation in a separate window.

Creating an Animation File from Screen Captures

Use the part file **Claw.sldprt** to create an animation (**.avi**) file from screen captures.

To create an animation file from screen captures:

- 1 Open file **Claw.sldprt**, which is in the same directory as the claw assembly.
- 2 Drag the rollback bar to before the first feature, **Base-Extrude**, so that nothing appears in the graphics window.
- 3 Click **Turn on screen capture**  or **Animator, Screen Capture, Turn on screen capture**.
- 4 In the **Save Animation to File** dialog box, set **Frames per second** to **1**, and click **Save**.
- 5 In the **Video Compression** dialog box, click **OK**.
- 6 In the FeatureManager design tree, rebuild the part by dragging the rollback bar down the tree one feature at a time.
- 7 Click **Turn off screen capture**  or **Animator, Screen Capture, Turn off screen capture**.

To replay the animation from file:

- 1 In Microsoft Explorer, find **Claw.avi** in the same directory as the model.
- 2 Double-click the file name to play the animation in a separate window.

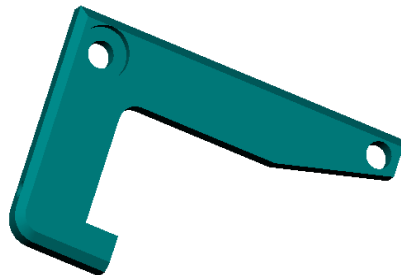

More about SolidWorks Functionality



SolidWorks 2001 offers a seamless integration with the Windows® environment, allowing you to benefit from its capabilities. It also allows you to include many add-in functions to enhance your productivity and efficiently manipulate the design environment. This section addresses some of these capabilities and functions.

For more information, see the *SolidWorks 2001 Online User's Guide*.

Importing and Exporting Files

You can import and export files using tools other than IGES, DXF, and STL shown in Chapter 18, “Importing Files / Using FeatureWorks Software.” Also included with the SolidWorks software are the following translation tools:

- ❑ **Solid, Surface, or Wireframe Standards.** STEP, ACIS®, VDAFS, and DWG
- ❑ **Graphics Standards.** VRML, TIFF, Metastream®, CATIA® Graphics, Highly Compressed Graphics, and ZGL
- ❑ **Direct Translators.** Parasolid™, Unigraphics®, Pro/ENGINEER®, Autodesk Inventor™, Solid Edge™, and Mechanical Desktop®

2D Sketching and Command Emulator

If you are familiar with 2D drafting with AutoCAD® using a command line interface, you can continue sketching in the same way by using the SolidWorks 2D Command Emulator. This is available as a standard add-in. To activate the 2D Command Emulator, click **Tools, Add-Ins** and select **SolidWorks 2D Emulator**.

By default the command insertion window is docked at the bottom of the screen, but you can move it to another position. To turn the visibility of the command line window on or off, click **2D Command Emulator** on the **View** menu. For more information about using the 2D Command Emulator, refer to the 2D Command Emulator Help online help.

Object Linking and Embedding

You can use Object Linking and Embedding (OLE) to take advantage of features of other applications while in a SolidWorks document. You can also link or embed a SolidWorks part, assembly, or drawing document to another OLE-compliant application.

For example, OLE allows you to bring data generated by another application, such as a word processing application, into the SolidWorks application. Or, you may want to include a SolidWorks part in another document, such as a product data sheet.

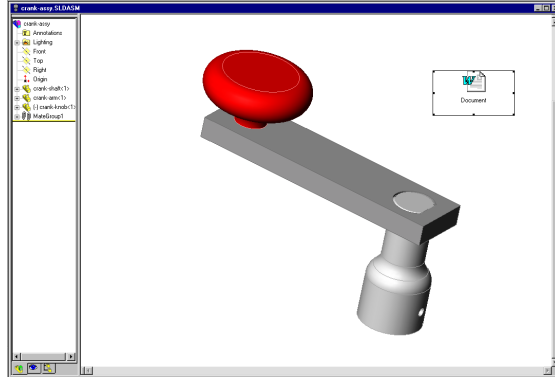

When using OLE, you can link or embed documents. Linking documents allows you to change the contents of a document in all places where it appears without having to edit each individual occurrence. Embedding a document allows you to keep any edits specific to the place in which you embedded it.

Rendering Models with the PhotoWorks Application

The PhotoWorks™ application is a photo-realistic rendering application that lets you create realistic images directly from SolidWorks models. The PhotoWorks application is a separately purchased add-in to the SolidWorks 2001 application. Like other add-ins, it is accessible by clicking **Tools, Add-Ins**.

Using the PhotoWorks application, you can specify model surface properties such as color, texture, reflectance, and transparency. PhotoWorks is supplied with a library of surface textures (metals, plastics, and so on) and, in addition, you can scan in and use your own bit-mapped surface textures, materials, scenery, and logos. For more information, see Chapter 19, “Learning to use PhotoWorks.”

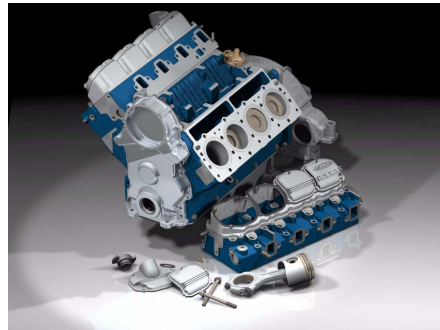

Engine subassembly: UAMZ

Identifying Features with the FeatureWorks Application

FeatureWorks™ is an application that recognizes a limited set of features on an imported solid in a SolidWorks part document. Once these features have been recognized, they are added to the FeatureManager design tree to be modified like any other SolidWorks features. The FeatureWorks application is primarily intended for machined parts and sheet metal parts.

The FeatureWorks application is a separately purchased and licensed application that can be ordered from the dealer from whom you purchased the SolidWorks software. The FeatureWorks application is supplied as a SolidWorks dynamic link library (.DLL) add-in to the SolidWorks 2001 application, and is accessible by clicking **Tools, Add-Ins**. For more information, see Chapter 18, “Importing Files / Using FeatureWorks Software.”

Animating Assemblies with the SolidWorks Animator Application

Like the FeatureWorks application, the SolidWorks Animator application is a separately purchased and licensed application. With the SolidWorks Animator add-in, you can animate and capture motion of SolidWorks assemblies.

The SolidWorks Animator application can generate Windows-based animations (.avi files) that you can play on any Windows-based computer. In conjunction with the PhotoWorks software, the SolidWorks Animator application can output photo-realistic animations.

The SolidWorks Animator application allows you to use:

- Animation Wizard** - to quickly create a fly-around animation, an exploded view animation, or a collapsed view animation
- Motion paths** - to explicitly create motion paths for various components in your SolidWorks assembly

Building Piping Systems

Piping is available as a separately purchased add-in. The SolidWorks Piping software supports routing functionality for fabricated pipes. You model the path of the pipe by creating a 3D sketch of the pipe centerline. The software uses the centerline definition to generate the pipe and elbow components for the route.

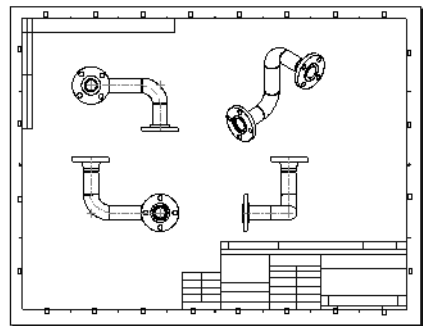

More about SolidWorks Functionality

The software makes extensive use of design tables to create and modify the configurations of routing components. The configurations are distinguished by different dimensions and properties.

You can add various types of fittings to the route, such as flanges, tees, crosses, and reducers. The fitting components must have configurations that match the pipe sizes.

Examining eDrawings

eDrawings eliminates the communication barriers that designers and engineers deal with daily. Compact and self-viewing, eDrawings are significantly easier to understand than standard 2D drawings.

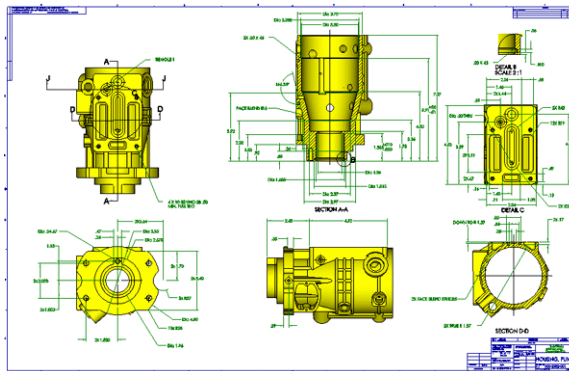

The following innovative features give you the capabilities that you need to overcome common barriers to effective 2D drawing communication:

- Virtual Folding** - Open individual views in a drawing and arrange them in any way you desire, regardless of how the views were arranged in the original drawing. Virtual Folding enables the eDrawings recipient to print and export any subset of a drawing.
- Hyperlinking** - Navigate through views automatically, ending searches for views or details. Simply click on the view annotation. That section view or detail is immediately added to your layout.
- 3D Pointer** - Identify and match geometry in multiple views. It is much easier to interpret what you are looking at when comparing that same location in all other views.
- Ultra Compact Files** - Send eDrawings using email. Substantially smaller in size than the original files, eDrawings make it practical to send 2D drawings via email, even over slow connections.
- Built-in Viewer** - View eDrawings immediately. Anyone with a Windows-based computer can view eDrawings. No additional CAD software or special viewers required. The eDrawing Viewer comes bundled with the eDrawing as a single email attachment.
- Animation** - Demonstrate automatically how drawing views relate to each other.

Creating Websites

SolidWorks 3D Instant Website allows you to create a web page from your SolidWorks application. The web page is based on a template and style that you can customize. The default templates that come with SolidWorks 3D Instant Website include:

- ❑ An embedded Metastream viewer for parts and assemblies and an eDrawings viewer for drawings
- ❑ A comment section where multiple reviewers can offer opinions
- ❑ Your company's contact information with a link to its home page

Additionally, you can create your web page on a password-protected secure site hosted by SolidWorks. With this feature, you do not need your own web server to share your designs with others outside your company. You can also create your web page on a local or network drive.

SolidWorks Application Programming Interface

The SolidWorks Application Programming Interface (API) is an OLE programming interface to SolidWorks. The API contains hundreds of functions that can be called from Visual Basic, VBA (Excel, Access, and so forth), C, C++, or SolidWorks macro files. These functions provide the programmer with direct access to SolidWorks functionality.

For a detailed description of the API and a list of all the new functionality added to the API since the last release of the SolidWorks software, refer to the API online help file. Click **Help, SolidWorks API Help Topics** to access the API help.

There is also a detailed description of the API functions on the SolidWorks Web page (<http://www.solidworks.com/html/products/api>).

Collaborating with Others

SolidWorks offers many tools that allow you to work in a multi-user environment or to share your design with others. These tools include:

- ❑ **SolidWorks 3D Meeting.** SolidWorks 3D Meeting is a SolidWorks application that interfaces with Microsoft Windows NetMeeting[®]. It enables you to share SolidWorks (or other applications on your system) with other users over the Internet.
- ❑ **SolidWorks 3D Instant Website.** SolidWorks 3D Instant Website allows you to create a web page from your SolidWorks application. The web page can include an embedded viewer and a comment section where multiple reviewers can offer opinions. Additionally, you can create your web page on a password-protected secure site hosted by SolidWorks. See **Creating Websites** for more information.
- ❑ **eDrawings.** eDrawings is the first email enabled communications tool designed to dramatically ease the sharing and interpretation of 2D mechanical drawings. You can share eDrawings with anyone who has a Windows-based computer as the eDrawings Viewer comes bundled with the eDrawing as a single email attachment. See **Examining eDrawings** for more information.
- ❑ **SolidWorks Explorer.** SolidWorks Explorer is a file management tool design to help you easily perform such tasks as renaming, replacing, and copying SolidWorks documents. See **Managing SolidWorks Documents** for more information.
- ❑ **FeaturePalette window.** The FeaturePalette window help you organize and use library features, sheet metal forming tools, piping components, and other commonly used parts. You can store palette items anywhere you want on a network so you can share them with your colleagues.
- ❑ **Open from Internet server.** You can open files residing on an Internet server. You can also modify then save the files back to an Internet server.
- ❑ **Copy Options Wizard.** After you customize your SolidWorks software, you can use the Copy Options Wizard to copy the options information set by one user and specify the same options on the machines of other users.
- ❑ **Hyperlinks in notes.** You can add an embedded hyperlink in a note, or you can add a floating hyperlink in any SolidWorks document. The hyperlink can be to a document on the Internet, on your local network, or on your own hard drive.
- ❑ **Reload/Replace.** You can refresh shared documents to reload the latest version including any changes made by one of your colleagues. You can replace a referenced document with another document from anywhere you want on a network.
- ❑ **Search paths.** When you open a parent document, the other documents that are referenced in the parent document are loaded into memory also. You can set the location where the SolidWorks software searches for referenced components to include shared folders for frequently used components.

Managing SolidWorks Documents

SolidWorks Explorer is a file management tool designed to help you easily perform such tasks as renaming, replacing, and copying SolidWorks documents.

SolidWorks Explorer is accessible from within the SolidWorks 2001 application. You can also open SolidWorks Explorer independently (by creating a shortcut on your desktop), and then open any SolidWorks documents from within SolidWorks Explorer.

To open SolidWorks Explorer from within the SolidWorks 2001 application, click **Tools, SolidWorks Explorer**. SolidWorks Explorer allows you to:

- View document dependencies for drawings, parts, and assemblies, using a tree structure.
- Copy, rename, or replace referenced documents. You have the option to find and update references to documents.
- View data and previews, or input data, according to the function you have active.

Use the following tools in SolidWorks Explorer to perform these tasks:



View any SolidWorks document on your system using the **Preview** tool. It is similar to using the shortcut menu in Windows Explorer for a **Quick View**.



View and edit specific, custom, or configuration-specific properties using the **Properties** tool. It also displays system data such as when the document was created and when it was last saved.



List all external references for SolidWorks documents using the **Edit References** tool.



Locate assemblies, drawings, or parts that reference a designated SolidWorks document using the **Where Used** tool.



Search for SolidWorks documents that meet a specified criterion, such as a custom property value, using the **Properties Search** tool.



List, rename, or delete configurations in an assembly or a part document using the **Edit Configurations** tool.



List, edit, and open any existing hyperlinks in a SolidWorks document using the **Edit Hyperlinks** tool.

Index

- 3 point arc 7-2
- 3D sketch 17-2
 - change planes 17-2
 - coordinate system 17-2
 - dimensions 17-2
 - relations 17-2, 17-3
 - space handle 17-2
 - virtual sharps 17-3
- A**
- adding
 - boss 3-8
 - components to an assembly 4-4
 - dimensions to a drawing 5-5
 - dimensions to a sketch 3-4
 - drawing sheet 5-7
 - geometric relations 7-3
 - mating relationships 4-6
- align. *See* mating
- alignment condition in assembly 11-10
- analyzing a design 12-2
- anchor 14-4
- animation
 - collapse 20-6
 - explode 20-4
 - help 20-2
 - motion path 20-3, 20-5, 20-7
 - play 20-6
 - record to file 20-8
 - rotate 20-3
 - schedule 20-2, 20-5
 - screen captures to file 20-8
 - SolidWorks Animator 20-1
 - toolbar 20-2
 - viewpoint 20-2
 - wizard 20-3
- AnimationManager tab 20-2
- annotations
 - balloon 14-6
 - datum feature symbol 13-6
 - geometric tolerance 13-6
 - note 13-8
 - surface finish symbol 13-6
- arcs
 - 3 point 7-2
 - centerpoint 10-2
 - tangent 7-3
- array. *See* pattern
- assembly 4-4
 - analysis of dependencies 12-2
 - bottom-up design 12-2
 - collapsing 11-18
 - creating 4-4
 - creating component in context 12-13
 - designing in context 12-3
 - dragging parts from another window 11-4
 - dragging parts from Windows Explorer 11-5
 - exploding 11-17

- inserting components from files 11-11
- lightweight components 11-3
- mating components 4-6, 11-6
- mold 16-6
- origin
 - inferencing 4-4, 11-4
 - overview 4-2
 - referenced configuration 12-12
 - resolved components 11-3
 - top-down design 12-2
- attach dimensions 18-5
- automatic
 - geometric relations 7-6
- axis
 - animation rotation 20-3
 - temporary 7-5

B

- balloon
 - inserting 14-6
 - options 14-2
- base feature
 - creating 3-6
 - loft 8-5
 - revolve 7-4
 - specifying depth 3-6
 - specifying end type 3-6
- bill of materials 14-3
 - anchoring 14-4
 - balloons 14-6
 - editing 14-5
 - inserting 14-3
 - moving 14-4
 - properties 14-3
 - saving 14-6
- BOM. *See* bill of materials
- boss
 - adding 3-8
 - loft 8-6
 - sweep 7-8

C

- cavity 16-7
 - scaling type 16-8
- centerline 7-4
- centerpoint arc 10-2
- chain dimensions 13-5
- changing

- color of a part 4-4
- dimension of feature 3-15
- name of feature 6-2
- circle 3-8
- circular pattern
 - creating 9-9
 - definition 9-1
 - equal-spacing 10-9
 - spacing 9-9
 - total instances 9-9
- collapsing
 - animation 20-6
 - assembly 11-18
 - FeatureManager design tree 11-5
- components
 - adding to an assembly
 - dragging parts from another window 4-4, 11-4
 - dragging parts from Windows Explorer 11-5
 - inserting from file 11-11
 - created in assembly 12-13
 - derived 16-9
 - lightweight 11-3
 - properties 12-12
 - resolved 11-3
- ConfigurationManager 2-4, 6-9
- configurations
 - created by suppressing features 12-11
 - generated by design table 6-9
 - in parts 12-3
 - referenced in assembly 12-12
- constrain all 18-5
- constraint. *See* relation
- context 12-13
- convert entities 4-3, 8-6
- copy
 - component instance 11-11
- copy and paste
 - sketch geometry 8-4, 18-5
- countersunk hole 12-6
- creating
 - assembly 4-4
 - base feature 3-6
 - boss 3-9
 - cavity 16-7
 - circular pattern 9-9
 - constant radius fillets 10-5

- cut 3-10
- dome 12-15
- drawing 5-2
- face blend fillets 10-4
- fillets 3-13
- linear pattern 9-8
- loft 8-5
- part 3-2
- planes 8-2
- revolve 7-2
- rounds 3-12
- sketch 3-2
- sweep 7-5
- thin feature 9-4
- variable radius fillets 10-6
- crosshatch 13-3
- cut
 - extruding 3-10, 7-9

D

- datum feature symbol 13-6
- defining relations 6-5
- deleting
 - design table 6-10
- derive component part 16-9
- design ideas 2-7
- design portfolio 2-7
- design table
 - closing 6-8
 - configurations 6-9
 - deleting 6-10
 - editing 6-10
 - embedding in document 6-8
 - inserting new 6-7
 - using to control parameters 6-7
- dialog box help 2-7
- dimension-driven system 2-2
- dimensioning standard 5-3
- dimensions
 - adding to a drawing 5-5
 - adding to a sketch 3-4, 17-2
 - attach 18-5
 - chain 13-5
 - diameter 3-9
 - displaying names 6-3
 - font 5-3
 - linear 3-9
 - linking values 6-3, 16-4
 - modifying in a drawing 5-6

- modifying on a part 3-5, 3-15
- ordinate 13-5
- properties 6-4, 13-5
- reference 13-5
- renaming 6-4
- setting standard 5-3
- witness lines 3-9
- display
 - dimension names 6-3
 - dimensions 16-4
 - feature dimensions 6-2
 - section view 3-16
 - toolbars 2-6
- display/delete relations 6-5, 7-6
- dome 12-15
- draft
 - feature 10-4
 - while extruding 16-2
- drawing
 - adding a sheet 5-7, 13-7
 - adding dimensions 5-5
 - creating 5-2
 - moving views 5-4
 - printing 5-9
 - specifying a template 5-2
 - standard 3 view 5-4
 - views 5-4
- drawing sheet format. *See* sheet format
- DXF files 18-4
- E
- edges
 - selecting hidden 9-5
- edit
 - animation path 20-5
 - assembly 12-15
 - bill of materials 14-5
 - color 4-4
 - design table 6-10
 - in separate window 6-7
 - exploded view 11-19
 - part in assembly 16-7
 - sheet format 5-2
 - sketch plane 8-4
- ellipse 7-7
- equation
 - used in a pattern 9-10
 - used with sketch dimensions 12-6, 12-8
- Excel

- creating a bill of materials 14-1
- editing a bill of materials 14-5
- editing design table 6-10
- inserting new design table 6-7
- saving a bill of materials 14-6
- exploded view
 - animation 20-4
 - assembly 11-17
 - drawing 13-7
- exporting STL files 18-7
- extend sketch entity 12-8
- external references 16-8
- extruding
 - base feature 3-6
 - boss 3-9, 17-5
 - cut 3-10
 - midplane 12-5
 - offset from surface 10-8
 - with draft 16-2

F

- faces
 - selecting hidden 9-5
- feature
 - changing the name 6-2
 - circular pattern 9-1
 - defined 2-3
 - displaying dimensions 6-2
 - dome 12-15
 - draft 10-4
 - fillet 3-13
 - hiding dimensions 6-2
 - hole wizard 12-6
 - linear pattern 9-1
 - loft 8-5
 - mirror 12-7
 - mirror all 10-7
 - naming 3-13
 - order 3-13
 - properties 6-2
 - renaming 6-2
 - shell 3-14
 - suppress 12-11
 - sweep 7-5
 - unsuppress 12-11
- feature handles 3-15
- FeatureManager design tree 2-4
- FeatureWorks 18-3

- fillet
 - adding 3-13
 - constant radius 10-5
 - face blend 10-4
 - sketch tool 9-2
 - variable radius 10-6
- font, dimensions 5-3
- foreshortened radius 7-5
- format. *See* sheet format
- fully defined sketch 3-4

G

- geometric tolerance 13-6
- getting help 2-7
- graphics area 2-4

H

- help
 - animation 20-2
 - design portfolio 2-7
 - in dialog boxes 2-7
 - online 2-7
 - online tutorial 2-7
 - tip of the day 2-7
 - tooltips 2-7
- hidden in gray 3-12
- hide
 - feature dimensions 6-2
 - toolbars 2-6
- hole wizard 12-6
- hollow. *See* shell

I

- IGES files 18-2
- import
 - DXF files 18-4
 - IGES files 18-2
- in-context 12-13
- inferencing
 - assembly origin 11-4
 - lines 7-2
- inplace mating relation 12-13
- inserting
 - balloon 14-6
 - bill of materials in drawing 14-3
 - component 4-4
 - dome 12-15
 - exploded view 11-17

- loft 8-5
- model items in drawing 5-5
- new component 12-13
- new design table 6-7
- plane 8-2
- revolve 7-4
- sweep 7-8
- installation
 - allow changes from drawing 1-2
 - client 1-3
 - individual 1-3
 - procedures 1-3
 - server 1-3
 - server and client 1-3
 - system requirements 1-2

J

- jog ordinate dimensions 13-5

L

- label letter 13-4
- layout sketch 12-7
- leader 13-8
- lightweight components, assembly 11-3
- line 7-2
- linear pattern
 - creating 9-8, 17-5
 - definition 9-1
 - total instances 9-8
- linking dimension values 6-3, 16-4
- list external references 16-8
- loft
 - creating 8-5
 - definition 8-1
 - inserting 8-5
 - ordering the sketches 8-5
 - setting up planes 8-2
 - sketching profiles 8-3

M

- mate components 4-6
- mategroup 11-4, 11-16
- material properties, transparency 16-6
- mating
 - automatic 11-12
 - coincident 11-7
 - concentric 11-6
 - distance 16-7
 - inplace 12-13

- parallel 11-10
- relationships 4-6
- tangent 11-11
- testing relationships 11-6
- midplane extrusion 12-5

mirror

- all 10-7, 17-6
- features 12-7
- multiple entities 9-7
- while sketching 16-2

modifying

- dimensions in a drawing 5-6
- dimensions on a part 3-5, 3-15

mold

- creating a mold base part 16-5
- cutting 16-9
- inserting the design part 16-6

moving

- bill of materials 14-4
- drawing views 5-4

N

named view

- adding to a drawing 5-8
- naming features 3-13

- on creation 6-2

new

- assembly 4-4
- drawing 5-2
- part 3-2
- note 13-8

O

- offset entities 4-3

- online help 2-7

- online tutorial 2-7

opening

- new part document 3-2
- sketch 3-2

options

- automatically load parts lightweight 11-3
- balloons 14-2
- bill of materials 14-2
- detailing 5-3
- dimensioning standard 5-3
- display dimension names 6-3
- drawings 13-4
- edit design tables in separate window 6-7
- font, dimensions 5-3

- name feature on creation 6-2
- show dimension names 16-4
- ordinate dimensions 13-5
- origin
 - assembly 11-4
- output to image file, PhotoWorks 19-12
- over defined sketch 3-4

P

- part
 - configurations 12-11
 - creating 3-2
 - opening new document 3-2
 - saving 3-7
- path, sweep 7-5
- pattern
 - circular, defined 9-1
 - linear 17-5
 - linear, defined 9-1
 - mirror all 17-6
 - mirror feature 12-7
- PhotoWorks
 - background scenery 19-27, 19-28
 - creating a backdrop 19-28
 - decals 19-23
 - fundamentals 19-2
 - material selection 19-7, 19-28
 - output to image file 19-12
 - saving image file 19-12
 - shaded rendering 19-4
 - view image file 19-13
- planes
 - 3D sketches 17-2
 - copying 8-2
 - creating 8-2
 - offsetting 8-2
- plotting drawings. *See* printing drawings
- preview
 - dimension 3-9
 - section view 3-16
- printing drawings 5-9
- profile
 - detail view 13-4
 - loft 8-3
- properties 13-4
 - bill of materials 14-3
 - component 12-12
 - dimension 6-4

- dimensions 13-5
- note 13-8
- sheet format note 5-2
- PropertyManager 2-4

R

- rebuild 5-6, 13-3
- recognizing features 18-3
- recording an animation 20-8
- rectangle 3-3
- reference plane 8-2
- referenced configuration 12-12
- references, external 16-8
- regenerate. *See* rebuild
- relation
 - adding 3-10, 17-2
 - coincident 7-8
 - collinear 10-3
 - concentric 3-10
 - constrain all 18-5
 - coradial 16-3
 - defining 6-5
 - display/delete 6-5, 7-6
 - equal 7-3
 - external information 7-6
 - geometric 3-10
 - horizontal 7-6, 7-7
 - midpoint 6-5
 - verifying 6-5
- relationship
 - coincident mating 11-7
 - concentric mating 11-6
 - distance mating 16-7
 - inplace mating 12-13
 - mating 4-6
 - parallel mating 11-10
 - tangent mating 11-11
- renaming
 - dimensions 6-4
 - features 6-2
- resolved components, assembly 11-3
- revolve 7-2
- rollback
 - bar 12-10
- rotate view 3-12
- round 3-12

S

saving

- bill of materials 14-6
- drawing 5-5
- drawing sheet format 5-2
- drawing template 5-3
- part 3-7

scale

- detail view 13-4
- sheet 13-2

schedule, animation 20-2

section

- sweep 7-7
- view 3-16, 13-3

selecting

- hidden edges 9-5
- hidden faces 9-5
- other 9-5

selection filter 4-3

service packs 1-4

shared values 6-3

sheet

- adding to drawing 5-7

sheet format 5-2

shell 3-14

show

- dimension names 16-4
- feature dimensions 6-2

sketch

- adding dimensions 3-4
- defined 2-3
- fully defined 3-4
- layout 12-7
- opening a new sketch 3-2
- over defined 3-4
- status 3-4
- under defined 3-4

sketching

- 3 point arc 7-2
- 3D 17-2
- centerline 7-4
- centerpoint arc 10-2
- ellipse 7-7
- extend 12-8
- fillet 9-2
- line 7-2
- loft profile 8-3
- tangent arc 7-3
- trim 7-3

slice. *See* section view

SmartMates 11-12

- flip alignment 11-12

SolidWorks 2001

- web site 1-5

SolidWorks Animator 20-1

space handle 17-2

standard 3 view drawing 5-4

status bar 2-7

STL files 18-7

suppress feature 12-11

surface finish symbol 13-6

sweep

- definition 7-5
- path 7-5
- section 7-7

system requirements 1-2

T

tab

- AnimationManager 20-2

- ConfigurationManager 6-9

table, design 6-7

tangent arc 7-3

template, drawing 5-2, 5-3

temporary axis 7-5

thin feature 9-4

tip of the day 2-7

toolbars 2-6

- animation 20-2

- display or hide 2-6

tooltips 2-7

transparency 16-6

trim 7-3

tutorial

- online 2-7

U

under defined sketch 3-4

unsuppress feature 12-11

update view 13-3

V

verify relations 6-5

view 13-4

- exploded 13-7

- label 13-4

- named 5-8, 13-7

- rotate 3-12

section 13-3
update 13-3
view image file, PhotoWorks 19-13
viewpoint, animation 20-2
views, drawing 5-4
virtual sharps 17-3

W

web site 1-5, 2-7

Z

zoom
to area 4-3