

**FUNDAMENTAL PROCESSES OF
DYE CHEMISTRY**

By **HANS EDUARD FIERZ-DAVID**
and **LOUIS BLANGEY**

Eidgenössische Technische Hochschule, Zürich

Translated from the Fifth Austrian Edition

By **PAUL W. VITTUM**

Eastman Kodak Company, Rochester, New York

Published and distributed in the public interest with the
consent of the Attorney-General under License No. A-1360

1949

INTERSCIENCE PUBLISHERS, INC., NEW YORK
INTERSCIENCE PUBLISHERS LTD., LONDON

43639

Translated from *Grundlegende Operationen der Farbenchemie*, Siebente Unveränderte Auflage, Springer-Verlag, Wien, 1947. The sixth (1946) and seventh (1947) Austrian editions are unchanged reprints of the fifth (1943) Austrian edition.

Copyright, 1922, Springer-Verlag OHG., Berlin. Copyright, 1938, 1943, Springer-Verlag OHG., Vienna. Copyright vested in the Alien Property Custodian, 1944, pursuant to law. Copyright, 1949, Interscience Publishers, Inc.

ALL RIGHTS RESERVED

This translation or any part thereof must not be reproduced without permission of the publishers in writing. This applies specifically to photostatic and microfilm reproductions.

INTERSCIENCE PUBLISHERS, INC.
215 Fourth Avenue, New York 3, N. Y.

For Great Britain and Northern Ireland:
INTERSCIENCE PUBLISHERS LTD.
2a Southampton Row, London, W. C. 1

PRINTED IN THE UNITED STATES OF AMERICA
OFFSET BY NEW YORK LITHOGRAPHING CORP., NEW YORK
COMPOSED BY GRAPHIC PRODUCTION CORP., NEW YORK

Preface to the Fifth Austrian Edition

This fifth edition of *Grundlegende Operationen der Farbenchemie* constitutes an expansion of the fourth edition. Since the appearance of the first edition in 1920, so many new processes of dye chemistry have been discovered that it appeared necessary to rework or enlarge various sections. In particular, the preparation of several important intermediates has been resurveyed.

The book is intended principally to introduce to the beginner the methods of dye chemistry, and not merely to present a collection of recipes. To this end, the chapter on the practical work in the organic industrial laboratory has been reworked and enlarged in order to clarify all the important points. The chapter on analysis of dyes has been revised so that the student may gain some insight into this difficult field. Also, the section on the determination of light fastness has been rewritten, and we are grateful to Dr. Ris (Basel) for his contributions to this subject. These additions have increased the scope of the book. We hope that they have also increased its usefulness.

H. E. Fierz-David
Louis Blangey

Zürich, November 3, 1942
Chem.-Techn. Laboratorium der
Eidgenössischen Technischen
Hochschule

Preface to the Translation

Twenty-eight years have elapsed since the publication of the first edition of *Grundlegende Operationen der Farbenchemie*. In the meantime the technology of dyestuff intermediates and the dyes obtained from them has developed widely, and the processes described in 1920 are very well known today.

Editions subsequent to the first (up to the seventh edition, published in Vienna in 1947) were expanded considerably in collaboration with L. Blangey. The main aim was always to explain the fundamental principles of dye chemistry to the student; and, since it was the endeavor of the authors to write a laboratory book and not an encyclopedia, in general only simple examples were given in this work. The preface to the first edition indicated that the processes described were perhaps not the best, but that by following the instructions exactly the results stated would be obtained. In dye chemistry, as is well known, many roads lead to the same goal.

The present edition is not intended to compete with more comprehensive books such as that of P. H. Groggins, *Unit Processes in Organic Synthesis* (1947). The latter is a textbook, while *Grundlegende Operationen der Farbenchemie*, like Gattermann's book *Praxis des Organischen Chemikers*, is primarily a laboratory manual. The reprinting of the fifth Austrian edition in the United States — without the consent of the authors — indicated recognition of the need for such a volume.

It seems appropriate, however, to publish a new, American edition in which several reactions are described that have not appeared in previous editions and which corrects minor errors discovered in the Austrian edition on which the translation is based. These are the only changes considered necessary.

After the present translation had been printed, the allied reports on German and Japanese industry were made public. The authors noted to their satisfaction that the processes they described corresponded closely in many cases with those of the German dye factories. Certain large-scale industrial reactions can be reproduced only with difficulty in the laboratory with the small amounts of material at the chemist's disposal. In our opinion, for example, it is practically impossible in the

laboratory to fractionate and crystallize out at low temperatures the mixtures of chlorotoluenes as described in BIOS Final Report No. 1145. On the other hand, we would like to point out here that 1-naphthylamine-3-sulfonic acid can be separated easily from the mixture of the 1,6-, 1,7-, and 1,8- acids by precipitating carefully with acid, according to FIAT Final Report No. 1016. The other processes correspond so closely with those we present that there is no need for further amendments.

We want to thank Dr. Paul W. Vittum for a translation that corresponds so well with the sense of the original German. We hope that this American edition will fulfill its purpose and be cordially received.

H. E. Fierz-David
Louis Blangey

Zürich, December 1, 1948
Swiss Federal Institute of Technology

CONTENTS

Preface to the Austrian edition	v
Preface to the translation	vii
Index of reactions	xix
List of figures	xxvii
List of tables	xxix
The foundations of the dye industry	1
I. INTERMEDIATES	
General discussion	3
The various operations of intermediate chemistry	6
Sulfonation	6
Nitration	6
Reduction	7
Introduction of the hydroxyl group	7
Introduction of amino and alkoxy groups	8
Oxidation methods	8
Introduction of halogen	9
Practical work in the industrial organic laboratory	10
General	10
Proportions and weighing	13
Laboratory journals and reports	14
Apparatus	14
Stirring apparatus	15
Filtration	18
Distillation	21
Distillation under ordinary pressure	21
Vacuum distillation	25
Steam distillation	25
Separation of reaction products	27
Basic substances	27
Acidic substances	30
Purification of products	34
Testing the product for purity	40
Orientation rules	50
Orientation in the benzene series	50
Orientation in the naphthalene series	53
Orientation in the anthraquinone series	56
Orientation in the carbazole series	60

A. Compounds of the benzene series	62
Chlorobenzene	62
Halogenation in general	65
Nitrobenzene	68
Nitration in general	69
The Lunge nitrometer	72
Aniline from nitrobenzene	75
Reduction in general	77
Benzenesulfonic acid	80
Sulfonation in general	82
Phenol	86
Alkali fusion in general	88
Derivatives of chlorobenzene	90
<i>o</i> - and <i>p</i> -Nitrochlorobenzene	90
<i>p</i> - and <i>o</i> -Nitroaniline from <i>p</i> - and <i>o</i> -nitrochlorobenzene	92
<i>p</i> -Nitrophenyloxamic acid and <i>p</i> -aminophenyloxamic acid	93
<i>p</i> -Nitrophenylhydrazine	95
<i>o</i> -Nitroanisole from <i>o</i> -nitrochlorobenzene	97
<i>p</i> -Nitrochlorobenzene- <i>o</i> -sulfonic acid and <i>p</i> -nitroaniline- <i>o</i> -sulfonic acid from <i>p</i> -nitrochlorobenzene	99
Diaminodiphenylaminesulfonic acid	99
Aminodiphenylaminesulfonic acid (III), and aminophenyltolylaminesulfonic acid	100
2,4-Dinitrochlorobenzene from chlorobenzene	101
<i>m</i> -Phenylenediaminesulfonic acid from 2,4-dinitrochlorobenzene	103
Aniline-2,5-disulfonic acid from chlorobenzene	104
2-Nitrochlorobenzene-4-sulfonic acid from chlorobenzene	104
Nitrobenzene-2,5-disulfonic acid	106
Aniline-2,5-disulfonic acid	106
4-Chloro-2-aminophenol from <i>p</i> -dichlorobenzene	108
Nitro- <i>p</i> -dichlorobenzene from <i>p</i> -dichlorobenzene	108
4-Chloro-2-nitrophenol from nitro- <i>p</i> -dichlorobenzene	109
4-Chloro-2-aminophenol from 4-chloro-2-nitrophenol	110
Derivatives of nitrobenzene	111
<i>m</i> -Dinitrobenzene from nitrobenzene	111
<i>m</i> -Nitroaniline from <i>m</i> -dinitrobenzene	113
Partial reductions in general	114
<i>m</i> -Phenylenediamine from <i>m</i> -dinitrobenzene	115
<i>m</i> -Chloronitrobenzene from nitrobenzene	116
2-Chloro-4-dimethylaminobenzaldehyde	118
<i>p</i> -Tolyhydroxylaminesulfonic acid	118
2-Chloro-4-dimethylaminobenzaldehyde	119
<i>m</i> -Nitrobenzenesulfonic acid and metanilic acid from nitrobenzene	120
2,2'-Benzidinedisulfonic acid from nitrobenzene	123
Benzidine from nitrobenzene	124

Derivatives of aniline	126
Sulfanilic acid from aniline (baking process)	126
The baking process in general	127
1-(<i>p</i> -Sulfophenyl)-3-methyl-5-pyrazolone from sulfanilic acid	128
Phenylhydrazine- <i>p</i> -sulfonic acid	128
<i>p</i> -Sulfophenyl-3-methyl-5-pyrazolone	129
<i>p</i> -Aminoacetanilide from aniline	129
Acetanilide from aniline	130
<i>p</i> -Nitroacetanilide from acetanilide	131
<i>p</i> -Aminoacetanilide from <i>p</i> -nitroacetanilide	132
Dimethylaniline (diethyl- and ethylbenzylanilines)	133
Ethylbenzylanilinesulfonic acid	136
Tetramethyl- <i>p,p'</i> -diaminodiphenylmethane from dimethylaniline and formaldehyde	137
Tetramethyl- <i>p,p'</i> -diaminobenzohydrol (Michler hydrol)	138
Tetramethyl- <i>p,p'</i> -diaminobenzophenone (Michler ketone)	139
Diphenylamine from aniline and aniline salt	140
Acetoacetanilide	142
Derivatives of benzenesulfonic acid	143
Benzene- <i>m</i> -disulfonic acid	143
Resorcinol	144
Derivatives of phenol	145
<i>o</i> - and <i>p</i> -Chlorophenol from phenol	145
Chloranil	146
<i>o</i> - and <i>p</i> -Nitrophenols and their ethers	147
Alkylation of nitrophenols	148
Trinitrophenol (picric acid)	150
Picramic acid	152
2-Aminophenol-4,6-disulfonic acid from phenol	153
Salicylic acid from phenol	154
<i>p</i> -Aminosalicylic acid	156
Preparation of the azo dye	156
Reduction	157
Derivatives of toluene	158
Benzal chloride and benzaldehyde from toluene	158
Benzal chloride	158
Benzaldehyde	158
2,6-Dichlorobenzaldehyde from <i>o</i> -nitrotoluene	160
Chloronitrotoluene from <i>o</i> -nitrotoluene	160
2,6-Chlorotoluidine	161
2,6-Dichlorotoluene	161
2,6-Dichlorobenzal chloride	162
2,6-Dichlorobenzaldehyde	162
Benzidine-3,3'-dicarboxylic acid from <i>o</i> -nitrobenzoic acid	164
2-Nitro-4-aminotoluene from <i>p</i> -toluidine	165
Dinitrostilbenedisulfonic acid and diaminostilbenedisulfonic acid from <i>p</i> -nitrotoluene (simultaneous oxidation of two molecules)	167

Dinitrostilbenedisulfonic acid	167
Reduction to diaminostilbenedisulfonic acid	168
2-Chloro-5-aminobenzoic acid	169
Gallamide and gallic acid from tannin	170
Benzene derivatives from naphthalene	171
Phthalic anhydride from naphthalene by catalytic oxidation	171
Preparation of the catalyst	171
Performing the reaction. Apparatus	172
Phthalimide from phthalic anhydride	173
Anthranilic acid from phthalimide	174
B. Compounds of the naphthalene series	175
α -Nitronaphthalene and α -naphthylamine	175
Phenyl- α -naphthylamine	179
α -Naphthol from α -naphthylamine	180
Naphthionic acid from α -naphthylamine	180
Preparation of the acid sulfate	180
Baking process	181
1-Naphthol-4-sulfonic acid (Nevile-Winther acid) from naphthionic acid (Bucherer reaction)	182
The sulfonic acids of naphthalene	183
1,6- and 1,7-Naphthylaminesulfonic acids (Cleve acids)	184
Naphthalene- β -sulfonic acid and β -naphthol	187
Sulfonation of β -naphthol	191
2-Naphthol-6-sulfonic acid (Schaeffer acid) (R acid and G acid)	194
2-Naphthol-6,8-disulfonic acid (G acid) and 2-naphthol-3,6-disulfonic acid (R acid)	197
2-Naphthylamine-1-sulfonic acid (Tobias acid) from β -naphthol	198
2-Naphthol-1-sulfonic acid from β -naphthol	199
2-Naphthylamine-1-sulfonic acid from 2-naphthol-1-sulfonic acid	200
1-Amino-2-naphthol-4-sulfonic acid from β -naphthol Preparation of an aminonaphtholsulfonic acid from the hydroxynitroso compound (quinonemon- oxime)	201
β -Naphthylamine from β -naphthol	203
2,8,6- and 2,5,7-Aminonaphtholsulfonic acids (Gamma and J acids) from β -naphthylamine	204
2,6,8- and 2,5,7-Naphthylaminedisulfonic acids from β -Naphthylamine	205
2-Amino-8-naphthol-6-sulfonic acid (Gamma acid)	207
2-Amino-5-naphthol-7-sulfonic acid (J acid, iso- Gamma acid)	207
From 2-naphthol-6,8-disulfonic acid	208
From G acid and 2,8-dihydroxynaphthalene-6- sulfonic acid	208
Phenyl-gamma acid	209

1-Naphthylamine-3,6-disulfonic acid (Freund acid)	209
1-Amino-8-naphthol-3,6-disulfonic acid (H acid)	211
1-Naphthylamine-3,6,8-trisulfonic acid (Koch acid)	211
1-Amino-8-naphthol-3,6-disulfonic acid (H acid)	213
1-Naphthylamine-5- and -8-sulfonic acids	214
1-Aminonaphthalene-4,8-disulfonic acid, 2-aminonaphthalene- 4,8-disulfonic acid, and 1-aminonaphthalene-3,8-disul- fonic acid	219
Naphthalene-1,4,5,8-tetracarboxylic acid from pyrene	221
Tetrachloropyrene	221
Naphthalenetetracarboxylic acid	222
C. Compounds of the anthraquinone series	224
Anthraquinone	224
Method 1: oxidation of anthracene	224
Method 2: from phthalic anhydride and benzene	225
o -Benzoylbenzoic acid	225
Anthraquinone	226
1-Amino-2-methylantraquinone	227
2-Methylantraquinone	227
1-Nitro-2-methylantraquinone	227
1-Amino-2-methylantraquinone	228
2-Aminoanthraquinone	228
Sodium anthraquinone-2-sulfonate ("silver salt")	228
2-Aminanthraquinone	229
1-Aminoanthraquinone and 1,4-diaminoanthraquinone	230
Anthraquinone-1-sulfonic acid	230
1-Aminoanthraquinone	231
1-Anthraquinonyloxamic acid	231
4-Nitro-1-anthraquinonyloxamic acid	232
1,4-Diaminoanthraquinone	232
1,5- and 1,8-Dihydroxyanthraquinone, and 1,5-dichloro- anthraquinone	234
Anthraquinone-1,5- and -1,8-sulfonic acid	234
1,5- and 1,8-Dihydroxyanthraquinone	236
1,5-Dichloroanthraquinone	236
1,5-Dinitroanthraquinone and 1,5-diaminoanthraquinone	236
1,5-Dinitroanthraquinone	237
Reduction to 1,5-diaminoanthraquinone	237
Quinizarin from p -chlorophenol	237
II. DYES	
D. Azo dyes	239
Laboratory preparation of azo dyes	239
Fundamental considerations	239
Diazotization	241
Examples	243

Coupling	249
Theoretical	249
Practical	252
Isolation of dyes	257
Dyes without sulfo or carboxyl groups	257
Dyes with sulfo or carboxyl groups	258
Technical diazotization procedures	259
Aniline	259
<i>p</i> -Nitroaniline	260
α -Naphthylamine	260
Sulfanilic acid	261
Benzidine	261
Coupling reactions	262
Single coupling reactions with hydroxy compounds	262
Acid orange A' or orange II	262
Acetyl-H acid and amidonaphthol red G	263
Fast light yellow G (Bayer)	265
Hansa yellow G	266
Permanent red 2G	267
Helio Bordeaux BL	268
Preparation of the sodium salt	268
Preparation of the calcium lake	269
Single coupling reactions with amines	270
<i>p</i> -Aminoazobenzene from aniline	270
Tropaeoline or orange IV and azo yellow from sulfanilic acid and diphenylamine	273
Tropaeoline or orange IV	274
Azo yellow (Indian yellow, helianthine, etc.)	275
Secondary disazo and polyazo dyes	277
Naphthylamine black D	277
Benzo light blue 2 GL or sirius light blue G	279
Aniline-2,5-disulfonic acid. α -Naphthylamine	279
Aniline-2,5-disulfonic acid. α -Naphthylamine. 1-Naphthylamine-7-sulfonic acid	280
Preparation of the trisazo dye	281
Disazo and polyazo dyes from diamines	282
Bismarck brown G and R	282
Bismarck brown R (Vesuvine R, etc.)	282
Chrysophenine G	283
Benzidine dyes	285
The intermediate from benzidine and salicylic acid (or from <i>o</i> -tolidine and <i>o</i> -cresotinic acid)	285
Dianil brown 3 GN	286
Diamine green B	288
Direct deep black EW	291
Congo red	293
Acid anthracene red G and chromocitronine R	294
Special methods	295
Eriochrome flavine A	295
Sun yellow G from <i>p</i> -nitrotoluene	296

E. Di- and triphenylmethane dyes	298
Auramine OO	298
Malachite green	299
Leuco malachite green	299
Oxidation of the leuco base to the dye	300
Xylene blue VS	301
Toluenedisulfonic acid	302
Benzaldehydedisulfonic acid	303
Condensation to the leuco dye	303
Oxidation to the dye	304
Wool blue 5B	305
Victoria blue B	306
Wool green S	307
F. Oxazine and thiazine dyes	308
Gallamine blue from gallamide	308
Nitrosodimethylaniline	308
Gallamine blue	309
Methylene blue from dimethylaniline	311
<i>p</i> -Aminodimethylaniline	311
Thiosulfonic acid of Bindschädler green	312
G. Anthraquinone dyes	314
Mordant dyes	314
Alizarin	314
Acid dyes	317
Quinizarin green or alizarin cyanine green G	317
Alizarin saphirol B and SE	319
Sulfonation and nitration	319
Reduction	320
Splitting out of one sulfo group	320
Vat dyes	321
Indanthrene blue RS from β -aminoanthraquinone	321
Indanthrene yellow GK	322
H. Indigoid dyes	323
Indigo	323
Heumann synthesis	323
Phenylglycine- <i>o</i> -carboxylic acid	323
Indoxylcarboxylic acid	324
Indigo	324
Traugott Sandmeyer synthesis	324
Thiocarbanilide	326
Hydrocyanocarbodiphenylimide	326
"Thioamide"	327
α -Isatinanilide	327
α -Thioisatin and indigo	329
Thioindigo	330
<i>o</i> -Carboxyphenylthioglycolic acid (O acid)	330
3-Hydroxythionaphthene	331

I. Sulfur fusions	332
Primuline	332
Chloramine yellow FF (naphthamine yellow NN and thiazole yellow	332
Separation of the melt	334
Naphthamine yellow NN (also FF) and thiazole yellow	335
Naphthamine yellow NN	335
Thiazole yellow or Clayton yellow	336
Sulfur black T from dinitrochlorobenzene	337
J. Phthalocyanines	338
Monastral fast blue BS, heliogen blue B	338

III. TECHNICAL DETAILS

K. Vacuum distillation in the laboratory and plant	341
L. The filter press	348
M. The construction and use of autoclaves	350
General rules on the use of pressure vessels	361
N. Construction materials for dye chemistry	362
Metals	362
Nonmetals	365
Materials of organic origin	367
O. Technical details of factory management	369
Charges	372
Steam consumption	372
Compressed air and vacuum	373
Function of the plant chemist	373
Manufacturing	373
Sample dyeing	375
Grinding	377
P. Calculation of costs for a simple dye	378
Orange II or acid orange A	378
β -Naphthol	378
Sodium β -naphthalenesulfonate	378
Fusion of the sodium salt	379
Sulfanilic acid	380
Nitrobenzene	380
Reduction of nitrobenzene	380
Sulfonation of aniline	380
Preparation of the dye from sulfanilic acid and β -naphthol	381

IV. ANALYTICAL SECTION

Preparation of standard titrimetric substances	384
Preparation of pure sulfanilic acid	384
Preparation of 1 N sodium nitrite solution	385
Preparation of 0.1 N phenyldiazonium solution	385

Determination of amines	386
Direct determination	386
Indirect determination	387
Determination of naphthols	387
β -Naphthol	387
α -Naphthol	388
Dihydroxynaphthalenes (molecular weight 160)	388
Determination of aminosulfonic acids	388
Determination of aminonaphtholsulfonic acids	389
H acid. 1-Amino-8-naphthol-3,6-disulfonic acids	389
Determination of naphtholmono- and -disulfonic acids and dihydroxynaphthalenemono- and -disulfonic acids	390
Example: Nevile-Winther acid (1-naphthol-4-sulfonic acid) (molecular weight 224)	390
Determination of 2-naphthylamine-5,7-disulfonic acid in the presence of 2-naphthylamine-6,8-disulfonic acid	391
Volumetric determination of dyes by the Edmund Knecht reduction method	392
Principle of the Knecht method	392
Preparation of the titanium trichloride solution	393
Titration of methylene blue	393
Azo dyes	394
Triphenylmethane dyes	394
The common test papers	395
Solution for spot tests on filter paper	396
Evaluation of zinc dust	396
Evaluation of lead peroxide paste	397

V. THE ANALYSIS OF COMMERCIAL DYES

Polar brilliant red 3B and B	404
Polar brilliant red 3B	404
Benzo light grey BL	407
Brilliant sulfo flavine (I.G.)	409
Literature on analysis of dyes	410

VI. THE DETERMINATION OF LIGHT FASTNESS

Tables I to XXI	417-465
Subject Index	467

INDEX OF REACTIONS

1. Halogenation	
General	9, 65
Direct chlorination:	
With chlorine:	
Chlorobenzene and dichlorobenzene from benzene	62
<i>m</i> -Chloronitrobenzene from nitrobenzene	116
Trichlorophenol from phenol	145
Benzal chloride from toluene	158
2-Nitro-6-chlorotoluene from <i>o</i> -nitrotoluene	160
2,6-Dichlorobenzaldehyde from 2,6-dichlorotoluene	162
Tetrachloropyrene from pyrene	221
With sulfuryl chloride:	
<i>o</i> - and <i>p</i> -Chlorophenol from phenol	145
Indirect introduction of chlorine:	
Replacement of —SO ₃ H by —Cl:	
1,5-Dichloroanthraquinone from anthraquinone-1,5-disulfonic acid	236
Replacement of —NH ₂ by —Cl (Sandmeyer reaction):	
2,6-Dichlorotoluene from 2-amino-6-chlorotoluene	161
Oxidative chlorination with aqua regia:	
Chloranil from trichlorophenol	146
Bromination:	
2,4-Dibromo-1-aminoanthraquinone from 1-aminoanthraquinone	233
2. Nitration	
General	6, 69
Nitrobenzene	68
<i>m</i> -Dinitrobenzene from nitrobenzene	111
<i>o</i> - and <i>p</i> -Nitrochlorobenzene	90
2,4-Dinitrochlorobenzene from chlorobenzene	101
Nitro- <i>p</i> -dichlorobenzene	108
2-Nitrochlorobenzene-4-sulfonic acid	104
<i>p</i> -Nitroacetanilide	131
<i>o</i> - and <i>p</i> -Nitrophenol	147
Picric acid from phenol	150
2-Nitrophenol-4,6-disulfonic acid	153
2-Nitro-4-aminotoluene	165
3-Nitro-6-chlorobenzoic acid	169
Azo yellow G from tropaeoline	276
α-Nitronaphthalene	175
1-Nitronaphthalene-5- and 8-sulfonic acid	215
1-Nitronaphthalene-6- and 7-sulfonic acid	184
1-Nitronaphthalene-3,6-disulfonic acid	209
1-Nitronaphthalene-3,8- and 4,8-disulfonic acid, and 2-nitronaphthalene-4,8-disulfonic acid	219

1-Nitronaphthalene-3,6,8-trisulfonic acid	211
1,5-Dinitroanthraquinone from anthraquinone	237
1-Nitro-2-methylantraquinone	227
4-Nitro-1-antraquinonyloxamic acid	232
4,8-Dinitro-1,5-dihydroxyanthraquinone-2,6-disulfonic acid	319
Methylene green from methylene blue	313
3. Nitrosation	
<i>p</i> -Nitrosodimethylaniline from dimethylaniline	308
1-Nitroso-2-naphthol from β -naphthol	201
Nitrosotropaeoline from tropaeoline	275
4. Reduction	
General	7, 77
—NO ₂ to —NH ₂ :	
Reduction of all the nitro groups present:	
Aniline (Fe)	75
<i>m</i> -Phenylenediamine from nitrobenzene (Fe)	115
Metanilic acid (Fe)	121
Aniline-2,5-disulfonic acid (Fe)	106
<i>m</i> -Phenylenediaminesulfonic acid (Fe)	103
<i>p</i> -Aminoacetanilide (Fe)	132
<i>p</i> -Aminophenyloxamic acid (Fe)	94
4-Chloro-2-aminophenol (Fe)	110
2-Aminophenol-4,6-disulfonic acid (Na ₂ S)	154
6-Chloro-2-aminotoluene (Fe)	161
<i>p,p'</i> -Diaminostilbenedisulfonic acid (Fe)	168
6-Chloro-3-aminobenzoic acid (Zn)	169
α -Naphthylamine (Fe)	176
1,5- and 1,8-Naphthylaminesulfonic acid (Fe)	215
1,6- and 1,7-Naphthylaminesulfonic acid (Fe)	186
1-Naphthylamine-3,6-disulfonic acid	210
1-Naphthylamine-3,8- and 4,8-disulfonic acid and 2-naphthylamine-4,8-disulfonic acid (Fe)	219
1-Naphthylamine-3,6,8-trisulfonic acid (Fe + H ₂ SO ₄)	212
1-Amino-2-methylantraquinone (Na ₂ S)	228
1,4-Diaminoanthraquinone (Na ₂ S)	232
1,5-Diaminoanthraquinone (Na ₂ S)	237
Alizarin saphirol B (NaSH)	320
Reduction of only one of several nitro groups (partial reduction):	
General	114
<i>m</i> -Nitroaniline from <i>m</i> -dinitrobenzene (NaSH)	113
Picramic acid from picric acid (Na ₂ S)	152
—NO ₂ to —NHOH:	
<i>p</i> -Tolylhydroxylamine- <i>o</i> -sulfonic acid (Zn)	118
—NO ₂ to —NH—NH—, followed by benzidine rearrangement:	
Benzidine from nitrobenzene (Zn)	124
Benzidine-2,2'-disulfonic acid (Zn)	123
Benzidine-3,3'-dicarboxylic acid (Zn)	164
—NO to —NH ₂ :	
<i>p</i> -Aminodimethylaniline (Zn)	311
1-Amino-2-naphthol-4-sulfonic acid (simultaneous sulfonation, with SO ₂)	201
—N=N— to —NH ₂ :	
<i>p</i> -Aminosalicylic acid (Na ₂ S ₂ O ₄)	157
Reductive splitting of polar brilliant red 3B (Na ₂ S ₂ O ₄)	404
Reductive splitting of polar brilliant red 3B (SnCl ₂)	404
Reductive splitting of benzo light grey BL (SnCl ₂)	407

—N=N+Cl ⁻ to —NH—NH ₂ :	
<i>p</i> - and <i>o</i> -Nitrophenylhydrazine from <i>p</i> - and <i>o</i> -nitroaniline (Na ₂ SO ₃ + NaHSO ₃)	95
Phenylhydrazinesulfonic acid (Na ₂ SO ₃)	128
Other reductions:	
Thiosalicylic acid from dithiosalicylic acid (Fe)	331
Leuco quinizarin from quinizarin (SnCl ₂)	318
Modern violet from gallamine blue (Na ₂ S)	310
α -Thioisatin from isatinanilide (NaSH)	329
5. Oxidation	
General	8
Phthalic anhydride from naphthalene (air)	171
Benzaldehyde-2,4-disulfonic acid from toluenedisulfonic acid (MnO ₂)	303
<i>p,p'</i> -Dinitrostilbenedisulfonic acid from <i>p</i> -nitrotoluene- <i>o</i> -sulfonic acid (NaOCl)	167
Naphthalene-1,4,5,8-tetracarboxylic acid from tetrachloropyrene (HNO ₃)	222
Anthraquinone from anthracene (CrO ₃)	224
Tetramethyldiaminobenzhydrol (Michler hydrol) from tetramethyldiaminodiphenylmethane (PbO ₂)	138
Malachite green from the leuco base (PbO ₂)	300
Xylene blue VS from the leuco compound (PbO ₂)	304
Wool green S from the leuco compound (CrO ₃)	308
Bindschedler green-thiosulfonic acid from dimethylaniline, <i>p</i> -aminodimethylaniline, and thiosulfate (CrO ₃)	312
Indigo from indoxylcarboxylic acid (air)	324
Thioindigo from 3-hydroxythionaphthene (S)	332
Naphthamine yellow NN from dehydrothiolutidinesulfonic acid (NaOCl)	335
Alizarin from anthraquinone- β -sulfonic acid (NaOCl in alkali fusion; simultaneous replacement of —SO ₃ H by —OH)	314
6. Sulfonation	
General	6, 82
Direct sulfonation:	
Benzenesulfonic acid (oleum)	80
Benzene- <i>m</i> -disulfonic acid (oleum)	143
Toluene-2,4-disulfonic acid (oleum)	302
<i>p</i> -Chlorobenzenesulfonic acid (oleum)	104
<i>m</i> -Nitrobenzenesulfonic acid (oleum)	120
<i>p</i> -Nitrochlorobenzene- <i>o</i> -sulfonic acid (oleum)	99
<i>p</i> -Nitrotoluene- <i>o</i> -sulfonic acid (oleum)	167, 296
Sulfanilic acid (baking process)	126
The baking process in general	127
Ethylbenzylaminesulfonic acid (oleum)	136
<i>p</i> -Aminoazobenzenedisulfonic acid (fast yellow) (oleum)	271
Azo flavine FF (100% H ₂ SO ₄)	272
Phenol-2,4-disulfonic acid (oleum)	150, 153
Naphthalenesulfonic acids, general	183
Naphthalene- α -sulfonic acid (100% H ₂ SO ₄)	215
Naphthalene- β -sulfonic acid (H ₂ SO ₄ , 66° Bé)	184, 187
Naphthalene-1,5- and 1,6-disulfonic acid (oleum)	219
Naphthalene-2,7-disulfonic acid (100% H ₂ SO ₄)	209
Naphthalene-1,3,6-trisulfonic acid (oleum)	211
β -Naphtholsulfonic acids, general	191
2-Naphthol-1-sulfonic acid (ClSO ₃ H)	199
2-Naphthol-6-sulfonic acid (H ₂ SO ₄ , 66° Bé)	194
2-Naphthol-3,6- and 6,8-disulfonic acid (H ₂ SO ₄ , 66° Bé; oleum)	194, 197
1-Naphthylamine-4-sulfonic acid (baking)	181

2-Naphthylamine-5,7- and 6,8-disulfonic acid (oleum)	205
Antraquinone-1-sulfonic acid (oleum + Hg)	230
Antraquinone-2-sulfonic acid (oleum)	228
Antraquinone-1,5- and 1,8-disulfonic acid (oleum + Hg)	234
1,5-Dihydroxyanthraquinone-2,6-disulfonic acid (oleum)	319
Alizarin pure blue B from the dye base (oleum)	233
Quinizarin green from the dye base (oleum)	318
Dehydrothiolutidinesulfonic acid (oleum)	334
Primuline from primuline base (oleum)	334
Indirect, replacement of —Cl by —SO ₃ H:	
2,4-Dinitrobenzenesulfonic acid from 2,4-dinitrochlorobenzene . . .	103
Nitrobenzene-2,5-disulfonic acid from 2-nitrochlorobenzene-4-sulfonic acid	106
Simultaneous reduction and sulfonation by SO ₂ :	
1-Amino-2-naphthol-4-sulfonic acid from nitroso-β-naphthol	201
7. Splitting out of sulfo groups	
Alizarin saphirol SE from alizarin saphirol B	320
8. Introduction of hydroxyl groups	
General	7, 88
Replacement of —SO ₃ H by —OH:	
Phenol	86
Resorcinol	144
β-Naphthol	188
2-Amino-8-naphthol-6-sulfonic acid	207
2-Amino-5-naphthol-7-sulfonic acid	207
1-Amino-8-naphthol-3,6-disulfonic acid	213
1,5- and 1,8-Dihydroxyanthraquinone	236
Alizarin from anthraquinone-β-sulfonic acid	314
Replacement of —Cl by —OH:	
4-Chloro-2-nitrophenol from nitro- <i>p</i> -dichlorobenzene	109
2,4-Dinitrophenol from 2,4-dinitrochlorobenzene	337
Azosalicylic acid (eriochrome flavine A) from chloroaminobenzoic acid-azo-salicylic acid	295
Replacement of —NH ₂ by —OH:	
α-Naphthol from α-naphthylamine	180
1-Naphthol-4-sulfonic acid from naphthionic acid	182
The Bucherer reaction in general	182
Direct introduction of —OH by oxidation	
Alizarin from anthraquinone-β-sulfonic acid	314
9. Introduction of alkoxy groups	
General	8
Replacement of —Cl by - <i>o</i> -alkyl:	
<i>o</i> -Nitroanisole from <i>o</i> -nitrochlorobenzene	97
Alkylation of phenols (see 14)	
10. Introduction of amino groups	
General	8
Replacement of —SO ₃ H by —NH ₂ :	
α-Aminoanthraquinone	231
β-Aminoanthraquinone	229
Replacement of —Cl by —NH ₂ :	
<p><i>p</i>- and <i>o</i>-Nitroaniline</p>	92
<p><i>p</i>-Nitroaniline-<i>o</i>-sulfonic acid</p>	99

Replacement of —OH by —NH ₂ :	
β-Naphthylamine from β-naphthol	203
2-Naphthylamine-1-sulfonic acid	200
Replacement of —CONH ₂ by —NH ₂ (Hoffmann degradation):	
Anthranilic acid from phthalimide	174
Reduction of —NO ₂ , —NO, or —N=N— (see 4)	
11. Introduction of arylamino groups	
Replacement of halogen by arylamino:	
4-Nitrodiphenylamine-2-sulfonic acid from <i>p</i> -nitrochlorobenzene- <i>o</i> -sulfonic acid and <i>p</i> -phenylenediamine	100
4-Nitro-4'-aminodiphenylamine-2-sulfonic acid from <i>p</i> -nitrochlorobenzene- <i>o</i> -sulfonic acid and <i>p</i> -aminoazobenzene	99
Dinitrophenylaminoazobenzene from 2,4-dinitrochlorobenzene and <i>p</i> -aminoazobenzene	272
4- <i>p</i> -Toluidine-2-bromo-1-aminoanthraquinone from 2,4-dibromo-1-aminoanthraquinone and <i>p</i> -toluidine	233
Replacement of —OH by —NH aryl:	
Quinizarin green base from leuco quinizarin and <i>p</i> -toluidine	317
12. Introduction of aldehyde groups	
2-Chloro-4-dimethylaminobenzaldehyde from <i>m</i> -chlorodimethylaniline, <i>p</i> -tolylhydroxylaminesulfonic acid and formaldehyde (see also 17)	119
13. Introduction of carboxyl groups (Kolbe-Schmidt synthesis)	
Salicylic acid from phenol	154
14. Alkylation	
Of amines:	
Dimethylaniline	133
Diethylaniline	134
Ethylbenzylaniline	134
Of phenols:	
<i>o</i> - and <i>p</i> -Nitroanisole and -phenetole	148
Chrysophenine from brilliant yellow	284
15. Phenylation	
Diphenylamine	140
Phenyl-α-naphthylamine	179
2-Phenylamino-8-naphthol-6-sulfonic acid (phenyl-γ acid)	209
16. Acylation	
Acetylation	
Acetanilide	130
1-Acetamino-8-naphthol-3,6-disulfonic acid (acetyl-H acid)	263
Oxalylation:	
<p><i>p</i>-Nitrophenyloxamic acid</p>	93
<p>Anthraquinonyl-1-oxamic acid</p>	231
Benzoylation:	
Indanthrene yellow GK	322
17. Hydrolysis	
<p><i>p</i>-Nitroaniline from <i>p</i>-nitroacetanilide</p>	132
<p><i>p</i>-Phenylenediamine from <i>p</i>-aminoacetanilide</p>	133
Benzaldehyde from benzal chloride	159
2,6-Dichlorobenzaldehyde from 2,6-dichlorobenzal chloride	162

2-Chloro-4-dimethylaminobenzaldehyde from chlorodimethylamino- benzal- <i>p</i> -toluidinesulfonic acid	119 328
Isatin from isatin- <i>a</i> -anilide	
18. Diazotization	
General	241
Aniline	156, 243, 259, 270
<i>p</i> -Chloroaniline	244
2,5-Dichloroaniline	244
<i>o</i> -Nitroaniline	97, 246
<i>p</i> -Nitroaniline	95, 246, 260
2,4-Dinitroaniline	247
2-Nitro-4-chloroaniline	247
3-Nitro-4-toluidine	246
3-Aminoacetanilide	245
<i>p</i> -Aminoacetanilide	249
<i>p</i> -Aminodiphenylamine	245
<i>p</i> -Aminoazobenzene	245
Sulfanilic acid	128, 248, 261, 262, 273
Aniline-2,5-disulfonic acid	279
Benzidine	261
Benzidine-2,2'-disulfonic acid	294
<i>p,p'</i> -Diaminostilbenedisulfonic acid	283
Anthranilic acid	330
6-Chloro-3-aminobenzoic acid	295
α -Naphthylamine	245, 260
1-Naphthylamine-3,6-disulfonic acid	277
1-Amino-2-naphthol-4-sulfonic acid	248
Dehydrothiotoluidinesulfonic acid	336
19. Coupling	
General	249
Aniline + aniline	270
Aniline + salicylic acid	156
Aniline + acetyl-H acid	264
Aniline + <i>p</i> -sulfophenylmethylpyrazolone	265
<i>p</i> -Nitroaniline + H acid	288
2,4-Dinitroaniline + β -naphthol	267
3-Nitro-4-toluidine + acetoacetanilide	266
Sulfanilic acid + <i>m</i> -phenylenediamine	287
Sulfanilic acid + diphenylamine	274
Sulfanilic acid + β -naphthol	262
Aniline-2,5-disulfonic acid + α -naphthylamine	279
6-Chloro-3-aminobenzoic acid + salicylic acid	295
1-Naphthylamine-3,6-disulfonic acid + α -naphthylamine	277
Dehydrothiotoluidinesulfonic acid + dehydrothiotoluidinesulfonic acid	336
<i>m</i> -Toluylenediamine + 2 <i>m</i> -toluylenediamine	282
Benzidine + salicylic acid	285
Benzidine + 2 naphthionic acid	293
Benzidine + H acid	291
Benzidine-2,2'-disulfonic acid + 2 β -naphthol	294
Benzidine-2,2'-disulfonic acid + 2 salicylic acid	295
Diaminostilbenedisulfonic acid + 2 phenol	283
(See also Table of Contents, under Azo Dyes)	
20. Condensation	
Acetoacetanilide from aniline and acetoacetic ester	142
Phenylglycine- <i>o</i> -carboxylic acid from anthranilic acid and chloroacetic acid	323
Phenylthioglycolic acid- <i>o</i> -carboxylic acid from thiosalicylic acid and chloroacetic acid	330

Thiocarbanilide from aniline and carbon disulfide	326
Tetramethyldiaminodiphenylmethane from dimethylaniline and formaldehyde	137
Tetramethyldiaminobenzophenone (Michler ketone) from dimethylaniline and phosgene	139
<i>p</i> -Sulfophenylmethylpyrazolone from phenylhydrazinesulfonic acid and acetoacetic ester	129
3-Hydroxythionaphthene from phenylthioglycolic acid- <i>o</i> -carboxylic acid	331
Indoxylcarboxylic acid from phenylglycine- <i>o</i> -carboxylic acid	324
α -Isatinanilide from thiooxamidodiphenylamidine	327
Indigo from α -thioisatin	329
<i>o</i> -Benzoylbenzoic acid and anthraquinone from phthalic anhydride and toluene	225
Quinizarin from phthalic anhydride and <i>p</i> -chlorophenol	237
Sun yellow from <i>p</i> -nitrotoluene- <i>o</i> -sulfonic acid	297
Leuco malachite green from benzaldehyde and dimethylaniline	299
Leuco xylene blue VS from benzaldehydedisulfonic acid and diethylaniline	303
Leuco wool green S from tetramethyldiaminobenzhydrol and R salt	307
Leuco wool blue 5B from <i>o</i> -chloro- <i>p</i> -dimethylaminobenzaldehyde and ethylbenzylanilinesulfonic acid	305
Victoria blue B from Michler ketone and phenyl- α -naphthylamine	306
Gallamine blue from nitrosodimethylaniline and gallamide	309
Methylene blue from Bindschedler green-thiosulfonic acid	312
Indanthrene blue RS from β -aminoanthraquinone	321
21. Introduction of sulfur	
Dithiosalicylic acid from <i>o</i> -diazobenzoic acid	330
Thiooxamidodiphenylamidine from hydrocyanocarbodiphenylimide	327
Dehydrothiotoluidine and primuline base from <i>p</i> -toluidine	332
Sulfur black T from 2,4-dinitrophenol	337
22. Miscellaneous	
Phthalimide from phthalic anhydride	173
Auramine from tetramethyldiaminodiphenylmethane	298
Hydrocyanocarbodiphenylimide from thiocarbanilide	326
α -Thioisatin from α -isatinanilide	329
Gallic acid and gallamide from tannin	170

FIGURES

1. Porcelain stirrers for attaching to a bent glass rod	17
2. Melting point apparatus	44
3. Thiele melting point apparatus	44
4. Iseli melting point apparatus	45
5. Laboratory chlorination apparatus	63
6a. Three-necked flask fitted with thermometer, filling funnel, and propeller stirrer with gas-tight seal	68
6b. Three-necked flask fitted with reflux condenser, dropping funnel, and paddle stirrer with gas-tight seal	68
7. Distillation apparatus for high-boiling liquids	71
8. Nitration kettle with auger-type stirrer, equipped for external and internal cooling	71
9. Separating funnel and extraction apparatus with propeller stirrer and transparent window	71
10. The Lunge nitrometer	73
11. Closed, coppered reduction vessel fitted with stirrer, dropping funnel, and reflux condenser	77
12. Hydraulic press with automatic cut-out on pump	79
13. Laboratory suction filter	81
14a. Fusion kettle for alkali fusions	87
14b. Fusion kettle with central thermometer tube	87
15. Temperature-pressure curves for aqueous sodium hydroxide solutions	89
16. Temperature-pressure curves for aqueous ammonia	92
17. Apparatus with propeller stirrer for Béchamp-Brimmeyr reductions	94
18. Reduction kettle with auger-type stirrer	96
19. Sulfonation and nitration vessel	101
20. Autogenously welded sulfonation vessel, especially for use with oleum	105
21. Screw press with wrought iron frame	107
22. Curve for determination of <i>p</i> -tolylhydroxylaminesulfonic acid	121
23a. Laboratory apparatus for distilling with superheated steam	141
23b. Laboratory distillation vessel for distilling with superheated steam	141

24.	Apparatus for large-scale distillation with superheated steam . . .	142
25a.	Method of introducing alkyl chloride into a laboratory autoclave	149
25b.	Auxiliary cylinder (gas pipe) for handling alkyl chlorides	149
26.	Stone filter funnel for strongly acid precipitates	150
27.	Portable filter for coarsely crystalline precipitates	151
28.	Apparatus for preparation of phthalic anhydride by catalytic oxidation	172
29.	Cast iron reaction kettle with stirrer for use at pressures up to 2 atm.	177
30.	Vacuum baking apparatus	181
31.	Sulfonation and nitration kettle with steam jacket (double wall) . .	191
32.	Graduated vessel for coupling reactions	263
33.	Centrifuge with bottom discharge	315
34.	Kettle heated with steam or hot water (Frederking)	316
35.	Reaction kettle (Samesreuther)	316
36.	Iron fusion kettle with copper oil bath for use in primuline, indigo, and alkali fusions, etc.	333
37.	Fractionating column with partial condenser	342
38a-b.	Kubierschky columns	343
38c.	Raschig column	343
39.	Rotary compressor and vacuum pump	345
40.	Vacuum distillation equipment for substances which solidify easily (naphthols, phenylenediamine, etc.)	346
41.	Laboratory vacuum distillation set-up	347
42.	Filter press	349
43.	Cast steel works autoclave	352
44.	Cast iron works autoclave with steam heating	353
45.	Cross section through an autoclave	355
46.	Cast steel laboratory autoclave with stirrer	357
47.	Cross section through the laboratory autoclave shown in Figure 46	358
48.	Vertical cast steel autoclave	358
49.	Rotating wrought iron autoclave with worm gear drive	359
50.	Cross section through the rotating autoclave	360
51.	Detail of the rotating autoclave	361
52.	Vacuum drying oven for dyes	373
53.	Sketch of the "Perplex" disintegrator	374
54.	Disintegrator for dyes	374
55.	Dye mixing machine with automatic filling and discharge	375
56.	Manufacturing area of a dye plant	376
57.	Step exposure	415

TABLES

I.	Derivatives of <i>o</i> - and <i>p</i> -dichlorobenzene	418
II.	Derivatives of chlorobenzene- <i>p</i> -sulfonic acid	420
III.	Derivatives of <i>o</i> -nitrochlorobenzene	422
IV.	Derivatives of <i>p</i> -nitrochlorobenzene	424
V.	Derivatives of 2,4-dinitrochlorobenzene	426
VI.	Derivatives of nitrobenzene	428
VII (a and b).	Derivatives of aniline	430
VIII.	Derivatives of benzenesulfonic acid and of phenol	434
IX (a and b).	Derivatives of toluene	436
X.	Derivatives of α -nitronaphthalene	440
XI.	Derivatives of naphthalene- α - and - β -sulfonic acids	442
XII.	Derivatives of β -naphthol	446
XIII (a and b).	Derivatives of 2-amino-5-naphthol-7- sulfonic acid (J acid)	448
XIV.	Derivatives of 2-naphthylamine-5,7-disulfonic acid	451
XV.	Other derivatives of naphthalene	452
XVI.	Derivatives of anthraquinone	454
XVII.	Derivatives of anthraquinone- β -sulfonic acid	456
XVIII.	Derivatives of anthraquinone- α -sulfonic acid	458
XIX.	Derivatives of α -aminoanthraquinone	460
XX.	Derivatives of alizarin	462
XXI.	Derivatives of β -methylantraquinone	464

The Foundations of the Dye Industry

The modern dye industry is built upon the coal tar industry as its source of material, and upon the Kekulé benzene theory as its scientific basis. Without these foundations, the dye industry could not have been developed.

The last thirty years have seen a very large increase in the number of raw materials for the dye industry, obtained by the dry distillation of coal tar. To the hydrocarbons known for a long time, such as benzene, toluene, xylene, naphthalene, and anthracene, have now been added many new compounds which previously were known only in scientific circles. These compounds could not be considered for industrial application until they had been obtained in large quantity and at low cost by coal tar distillation. Some of these newer raw materials are, for example, carbazole, quinoline, pyridine, acenaphthene, pyrene, chrysene, indene, and other coal tar constituents which are now used in large quantities for the preparation of valuable dyes. Various other hydrocarbons and nitrogen-containing compounds have been placed on the market but have found no industrial application as yet, although some of these may prove to be useful in the future. No uses have been found for phenanthrene, for example, although it is available in almost unlimited amounts. The homologs of benzene which are present in coal tar in only relatively small quantities have also been synthesized, in recent years, from aliphatic hydrocarbons.

With the increasing demands of the dye plants, the purity of the raw materials has steadily improved, and today many of these products may be called chemically pure. Modern methods have permitted the direct manufacture of pure compounds by fractional distillation and fractional crystallization. These improved techniques of the tar industry have resulted from extensive work and they constitute one of the foundations for the manufacture of intermediates for the dye industry.

Generally, the supply of the necessary raw materials satisfies the demand. It is interesting to note, however, that in recent years there has been an increase in the price of naphthalene, which previously was usually available in excess. This situation has arisen because changes in

gas manufacture by chamber distillation have resulted in the pyrolytic decomposition ("cracking") of the greater part of the naphthalene present in the tar. This situation has naturally had an effect on dye intermediates derived from naphthalene (phthalic anhydride, anthraquinone, H acid, naphthols, etc.).

I. Intermediates

General Discussion

The term *intermediates* refers to those compounds which are prepared from the original coal tar constituents by various chemical procedures and which, in turn, can be converted into commercial dyes by relatively simple further transformations. A typical example is *aniline*, which is prepared from benzene in various ways, and which can be converted into numerous dyes.

The reactions used in the preparation of intermediates are, for the most part, simple operations. Frequently, they proceed quantitatively according to the rules of stoichiometry. In other cases, side reactions are encountered which complicate the reaction and greatly reduce the yield. It is one of the important tasks of the dye chemist to study these undesirable side reactions sufficiently to understand their nature and then, if possible, to select the reaction conditions which will favor only the main reaction leading to the desired intermediate. This end is not always attained, because often the set of conditions which will eliminate the side reactions is not known, but the chemist must always bear in mind the possibility of achieving these conditions by further study. The preparation of 1,8-aminonaphthol-3,6-disulfonic acid (H acid) illustrates this point. This compound has been known for nearly fifty years and is still being studied extensively in many laboratories, yet to this day has not been prepared in satisfactory yield.

In many cases, so-called quantitative yields are obtained but the product is not a pure compound. Thus, the reaction yields the calculated quantity of product, but this is a mixture of isomeric or analogous compounds which must be separated by some type of physical method. The isomeric nitrotoluenes (*ortho*, *meta*, and *para*),

for example, are always obtained in mixture, and special methods have had to be evolved to separate the pure individuals economically. Sometimes a circuitous route can be followed to arrive at an uncontaminated intermediate. For example, a substituent (usually a sulfo group) may be introduced and split out later (e.g., the preparation of *o*-chlorotoluene, page 163). In other cases, the reactions are selected so as to prevent the formation of undesirable isomers — as in the preparation of “Tobias acid” (2-naphthylamine-1-sulfonic acid). This intermediate cannot be obtained directly from β -naphthylamine, but can be prepared under the proper conditions from β -naphthol (see page 198).

As already mentioned, the basic operations of dye chemistry utilize simple chemical reactions. An intermediate can frequently be prepared in several entirely different ways and, in these cases, careful calculations must be made to determine which procedure is most advantageous. The least expensive process is often not necessarily the best when other factors are taken into account. For example, the question of apparatus may enter, and calculations may show that it is uneconomical to purchase an expensive apparatus for the process if a small quantity of the material is to be produced. Furthermore, consideration must be given to the usability of the side products formed. These often cannot be used at all (e.g., primuline), but may be valuable or even indispensable in another process (e.g., chromium sulfate in the production of anthraquinone).

In evaluating a manufacturing procedure, the apparatus in which the operations are carried out must always be considered. Unlike preparations done in the laboratory, those in the plant cannot be carried out in glass equipment — except in unusual cases. Furthermore, it must be remembered that the chemicals often attack the apparatus, so its amortizement is an important consideration.

Most of the intermediates entering into the preparation of commercial organic dyes are members of the aromatic series. The substituents most frequently present are methyl, halogen (usually chlorine), nitro, amino, hydroxyl, alkoxyl, sulfo, carboxy, and (in some cases) aldehyde and ketone groups — the latter also in the form of quinone groups. These substituents, and other less common ones, may be introduced into the molecule either singly or in combination, and their introduction may be made in various sequences and in different manners, so that the number of possibilities is practically unlimited. Obviously, however, practice is governed by general principles, and the chemist who knows the fundamentals and has a command of the methods can easily determine the simplest method for preparing a desired compound.

Stoichiometric quantities of reactants are almost always used, and only in the most unusual cases is it necessary to use more or less of a reactant than the quantity demanded by the chemical equation. On the other hand, diluents must often be used in order to have the correct mixture during the reaction. It should also be emphasized that intensive mixing (stirring) is usually necessary for the satisfactory progress of the reaction. Also, the reaction temperature often plays an important role, for example, in preventing the formation of undesirable isomers.

In view of the factors cited, it is frequently quite unnecessary to give an exact “recipe” for the preparation of a product. Instead, the chemist is given an indication of the general principles involved and he, on the basis of his own experience, is immediately in a position to set up his own satisfactory procedure.

Accordingly, in this book the compounds in the tables are arranged in a genetic system, the derivatives being listed under their parent substances. This form of presentation has the advantage of giving the beginner a clear picture of the similarities in the reactions and, at the same time, giving information to the expert as to the preparation of the compound he desires. In order to increase the usefulness of these tables, there are included references, either to a procedure given in this book or to a literature source such as patents, scientific publications, etc., which describe the type of preparation for most of the compounds. *Obviously, since it has not been possible to consider all possibilities in a relatively small laboratory book, the tables are necessarily incomplete and give only a general outline.* The book is designed principally for the beginner, and it is hoped that it will serve for teaching purposes in the industrial chemical laboratory. The expert, however, may also find some use for the tables, particularly those relating to fields which are not his special provinces.

The subject material for the text of the book has also been arranged genetically. It covers, first, the most important operations: chlorination, nitration and reduction, sulfonation and alkali fusion, starting with the simplest basic structure, benzene. From the intermediates thus obtained, more complicated derivatives are built up by reaction series serving as illustrative examples. Following this, the derivatives of benzene homologs are treated in a similar manner, then the derivatives of naphthalene, and finally those of anthraquinone. Such an arrangement simplifies the study since not only is each intermediate traced from its parent structure but also its possible further transformations into more complicated intermediates are shown. In this way the beginner is taught to consider each operation both by itself and in connection with the total synthesis.

The Various Operations of Intermediate Chemistry

In this section some of the most important operations are described in general terms, intentionally avoiding specific comments about individual compounds. All the variations cannot be mentioned because this would lead to too great detail.

1. Sulfonation

By sulfonation is meant the introduction of an $-\text{SO}_3\text{H}$ group into a molecule. The operation results in a product which is usually very soluble in water, either in the form of the free sulfonic acid, as is often the case, or in the form of its salts. Of the salts, the inexpensive sodium salt is usually encountered.

Sulfonation is effected: (1) with ordinary concentrated sulfuric acid (66°Bé); (2) with 100 per cent sulfuric acid; (3) with fuming sulfuric acid (oleum), with the concentration of SO_3 varying from 5 to 70 per cent; (4) with chlorosulfonic acid, with or without diluent; or (5) by "baking" (dry heating) the acid sulfate of an amine, often in vacuum.

Less frequently the sulfonic acid group is introduced indirectly: (6) by replacing a halogen atom with the sulfonic acid group by means of sodium sulfite; (7) by the action of bisulfite on a nitro compound or on a quinone or quinoneoxime (nitrosophenol); (8) by oxidation of a sulfinic acid, a mercaptan, or a disulfide; and (9) by the introduction of the $-\text{CH}_2\text{SO}_3\text{H}$ group by means of formaldehyde-bisulfite.

2. Nitration

Nitration means the introduction of the nitro group, $-\text{NO}_2$, into a molecule. It is accomplished: (1) with dilute or concentrated nitric acid; (2) with mixed acid, i.e., a mixture of nitric and sulfuric acid, sometimes containing some water; (3) by first sulfonating the compound and then nitrating the sulfonic acid, thereby splitting out the sulfo group and replacing it by the nitro group (picric acid, see page 150); (4) by oxidizing with dilute nitric acid a previously formed nitroso compound (tropaeoline, see page 275); and (5) by treatment of a diazonium compound with hot, dilute nitric acid, introducing simultaneously a hydroxyl group and a nitro group (e.g., nitroresol from *p*-toluidine).

On nitration to produce a dinitro compound, the two nitro groups enter into positions meta to each other, but the reaction product is never uncontaminated (see, e.g., *m*-dinitrobenzene, page 111).

3. Reduction

The reduction most frequently encountered by the dye chemist is the transformation of a nitro compound into an amine, but numerous other reductions play an important role in dye chemistry. The following methods are employed.

(1) Reduction with iron and water, with the addition of small amounts of acid (hydrochloric, sulfuric, or acetic acid, and occasionally mixtures of these). This "neutral" reduction method of Béchamp-Brimmeyr can be carried out only with certain kinds of iron, notably gray-iron casting, which must always be tested previously to establish its usability. In general, other kinds of iron are *not usable* (many examples have been given).

(2) Reduction with iron and enough acid so that all of the iron used in the reduction goes into solution as the ferrous salt. For this purpose, any kind of iron can be used but it is desirable to use a variety low in carbon, for example, iron nails, iron plate, steel, etc., so that no contaminating graphite particles are formed (see H acid, page 212).

(3) Reduction with hydrogen sulfide or its salts (many examples are given in this book).

(4) Reduction with zinc dust and acid or alkali (rarely with tin).

(5) Reduction with hydrosulfite (e.g., *p*-aminosalicylic acid from phenylzosalicylic acid, page 157).

(6) Electrolytic reduction, as in the preparation of hydrazobenzene from nitrobenzene, or of *p*-aminophenol from nitrobenzene. The latter reduction involves a simultaneous rearrangement of the intermediate phenylhydroxylamine.

(7) Reduction with ferrous hydroxide, $\text{Fe}(\text{OH})_2$, now seldom used.

(8) Reduction with aluminum powder, for example, in the preparation of benzanthrone, or of quinizarin from purpurin (seldom used).

(9) Catalytic reduction with hydrogen.

(10) Reduction with sulfur dioxide, often giving simultaneous sulfonation.

4. Introduction of the Hydroxyl Group

The hydroxyl group can be introduced into a molecule in various ways.

(1) Fusion of a sulfonic acid with sodium hydroxide. This method is often referred to as "potash fusion," a term applied when potassium hydroxide was used almost exclusively. The cheaper sodium hydroxide is now almost always used. Dilute or concentrated hydroxide is employed, depending on the conditions. In using dilute sodium hydroxide (30 to 60 per cent), it is necessary to work in an autoclave if the reaction temperature is higher than the boiling point. The pressure makes no direct contribution to the reaction, but is necessary, unfortunately, to maintain the reaction temperature. Some variations of the procedure follow. (a) Alkali fusion in the presence of an oxidizing agent, whereby, in addition to the replacement of the sulfonic acid group by hydroxyl, a second hydroxyl group is introduced (see alizarin, page 314). (b) Alkali fusion in the presence of an alkaline-earth hydroxide, which precipitates the sulfite formed in the reaction as the insoluble alkaline-earth sulfite, and thus prevents reduction of the final product (anthraquinone series, see 2-aminoanthraquinone, page 229).

(2) Replacement of a labile halogen by the hydroxyl group, e.g., dinitrophenol from dinitrochlorobenzene, and many other similar preparations (see sulfur black T, page 337).

(3) Heating a diazonium salt, sometimes in the presence of copper salts (hydroquinone from *p*-aminophenol, or guaiacol from *o*-anisidine).

(4) Treatment of an amine with bisulfite, and hydrolysis of the intermediate compound (Bucherer's method, page 182).

(5) Heating as amine with acid or alkali under pressure.

(6) Frequently, by treatment with weak alkali, an ortho sulfo or nitro group, or a chlorine atom, in a diazonium salt is smoothly replaced by the hydroxyl group.

5. Introduction of Amino and Alkoxy Groups

The introduction of amino and alkoxy groups into aromatic molecules is frequently accomplished by methods analogous to those used for introducing the hydroxyl group. Thus, for example, nitrochlorobenzene and anthraquinone derivatives in many cases can be transformed into amino or alkoxy compounds. The sulfonic acid group can be replaced by an amino group, as can also the hydroxyl group, the latter by heating with ammonia, or, better, by the Bucherer method of heating with ammonium bisulfite.

Aminoanthraquinone affords an example of the replacement of a sulfonic acid group by amino. More recently, however, it has been found better to prepare 2-aminoanthraquinone from 2-chloroanthraquinone, since this leads to a purer product. *o*- and *p*-Nitroanilines are prepared today almost exclusively from the corresponding nitrochlorobenzenes (page 92).

The alkyl ethers of phenols, naphthols and hydroxyanthraquinones can be prepared, in many cases, by treatment of the halogen compounds with alcoholates at high temperature under pressure (e.g., anisole, page 97). Of course, the phenols themselves can be etherified (cf., page 148), and the cheaper method is used in each case. The dialkyl sulfates serve as active alkylating reagents in certain instances, as in the preparation of Caledon jade green (dimethoxydibenzanthrone).

6. Oxidation Methods

Many methods have been evolved for oxidizing organic compounds. Oxidation may be brought about by:

(1) Air, often in the presence of a catalyst. Examples of this method are the preparation of phthalic anhydride from naphthalene by air and vanadium oxide (Wohl's method, page 171), and the analogous oxidation of anthracene to anthraquinone. In the latter case, anthracene which is not entirely pure can be used.

(2) Chromic acid. This method is very important in the preparation of many heterocyclic dyes, such as methylene blue. The reaction is frequently carried out in the presence of oxalic acid.

(3) Manganese dioxide (MnO_2), or the so-called "Weldon mud" which is a manganous-manganic oxide (xylene blue V, page 303).

(4) Sodium hypochlorite (see dinitrostilbenedisulfonic acid, page 167).

(5) Nitric acid (seldom used).

(6) Lead peroxide, for triphenylmethane dyes.

(7) Nitrosylsulfuric acid (aurin dyes by Sandmeyer's method).

(8) Ferric chloride (with certain triphenylmethane dyes, e.g., Helvetia blue).

(9) Chlorination of a side chain (in toluene and xylene) followed by hydrolysis of the chlorinated product. Examples of the procedure are:

(a) toluene \rightarrow benzyl chloride \rightarrow benzyl alcohol, or

(b) toluene \rightarrow benzal chloride \rightarrow benzaldehyde.

(10) An excess of one of the dye-forming reactants (examples are very numerous, e.g., gallamine blue, Meldola's blue, etc.).

7. Introduction of Halogen

Halogen atoms, usually chlorine or bromine (rarely iodine or fluorine¹) are generally introduced by the action of the elementary halogen on the compound to be substituted. It is often necessary to use a catalyst; otherwise chlorine adds instead of substitutes (replacing hydrogen). The catalyst most commonly employed is iron (ferric chloride), sometimes iron with a trace of iodine and, less frequently, antimony, sulfur, or phosphorous compounds.

In place of elementary chlorine (bromine), sodium hypochlorite in the presence of mineral acid is used in certain cases (e.g., chlorination of acet-*o*-toluidide). The nascent chlorine reacts very energetically and undesirable side reactions do not occur.

If for any reason the direct introduction of chlorine is not possible, or the chlorine does not enter the desired position in the molecule, recourse may be had (but rarely!) to the Sandmeyer reaction (see example on page 161). In some cases, the Sandmeyer reaction can be avoided (it is rather bothersome and expensive) by the use of a trick reaction, such as in the preparation of *o*-chlorotoluene from *p*-toluenesulfonic acid² (page 163).

Other methods may be used for halogenating phenols. Thus, phenol-

¹ See, for example, Hoffa and Müller (I.G.), Ger. Pat. 551,882 (1932) [*Frđl.*, 19, 1625 (1934); *C.A.*, 26, 4959 (1932)]; and Osswald, Müller, and Steinhäuser (I.G.), Ger. Pat. 575,593 (1933) [*Frđl.*, 20, 475 (1935); *C.A.*, 27, 4813 (1933)].

² Badische A. und S.F., Ger. Pat. 294,638 (1916) [*Frđl.*, 12, 908 (1914-1916); *C.A.*, 11, 2582 (1917)].

ate and hypochlorite react to produce chiefly the *o*-chlorophenol (75 to 80 per cent), while the reaction of free phenol and sulfuryl chloride yields *p*-chlorophenol as the chief product (about 78 per cent)³ (see page 145).

In special cases, chlorination is brought about by replacement of a sulfonic group by chlorine. This reaction is particularly important with anthraquinone compounds, but it is also known in the benzene series (see page 236).

These reactions do not by any means cover the whole field, but represent only the more important portions of it. Later in this book, other less important reactions are mentioned, such as *alkylation of amines*, *introduction of the aldehyde group* by the Sandmeyer method, and *phenylation*. Although some of these reactions are carried out on a large scale, especially in the preparation of alkyl- and benzylanilines and toluidines, they are in terms of quantity of considerably less importance than the operations discussed above.

In all industrial operations, the chemist must always strive to achieve the greatest yield at the smallest cost. The methods which are suitable for scientific research frequently are not successful in industry. It must also be remembered that the intermediates should be as pure as possible because small variations in purity often lead to disproportionately large losses in the manufacture of the dye. For this reason, many of the commercially available intermediates are chemically pure, and the requirements in recent years have become even more exacting.

Practical Work in the Industrial Organic Laboratory

General

It cannot be overemphasized to the beginner in organic industrial work that *absolute cleanliness of work* is the first requirement for success, not only in analytical and research laboratories, but also in the industrial laboratory. This applies both to the apparatus and containers and to the materials employed. Keeping the apparatus clean is often more difficult than it is in the analytical laboratory because the industrial work involves materials which are more strongly colored and, not infrequently, tarry. Also, non-transparent containers are usually employed and the cleanliness of these is not so easily determined. Under these conditions, special attention is given to cleaning each vessel thoroughly, *immediately* after emptying it. Immediate cleaning is to

³ *Frdl.*, 7, 90 (1902-1904) (Note).

be recommended also because it may often be effected satisfactorily with hot water, either alone or with small quantities of acid or alkali, whereas a residue, once dried and crusted, may be much more difficult to remove, requiring powerful solvents such as sulfuric and chromic acids. In many cases, ordinary household cleaning powders are very useful in removing oily and tarry residues.

If the chemist does not clean his own apparatus, or have it cleaned under his direct supervision, he must be very careful not to leave containers with residues which are highly inflammable or explosive or strongly poisonous (such as ether, alkali metals, sodium amide, dimethyl sulfate, phosgene, etc.). The neglect of this rule has resulted in many accidents, since the person cleaning the apparatus is not aware of the danger. Residues of this sort should not be emptied into the laboratory sink, but should be treated so as to make them as harmless as possible.

The work table should always be kept clean and uncluttered. It is then possible to recover substances which have been spilled and thus save an experiment which otherwise would have to be repeated from the beginning. In experiments which require prolonged strong heating, the table top should be protected from the burner by a fire-resistant, insulating cover, such as asbestos or "Transite." Apparatus no longer in use should not be left in the working space. If space permits, it is desirable to place larger apparatus outside of the working space proper, and reserve the latter area for test tube experiments, titrations, melting point determinations, and so forth. *All necessary equipment for control tests should be readily available*, including clean, dry test tubes, glass rod and glass tubing, small filters and funnels, and the most common reagents and test papers.

The use of *pure materials* is at least as important as the cleanliness of the apparatus. In analytical and research laboratories, the use of chemically pure reagents is understandable, since, as a rule, only small quantities of materials are used and the cost is of no importance. In industrial laboratories, however, cost considerations usually prohibit the use of chemically pure materials and furthermore one is often restricted to the use of commercially available starting materials in order to duplicate plant conditions.

It is the general rule, however, in preparing *new products* and in working out *new procedures* to use the purest substances possible without regard to their cost and commercial availability. Later it is established whether the same results can be obtained with technical materials.

In most cases the *inorganic chemicals* used in industrial organic work are usable in the form supplied commercially. There are, however, important exceptions. For example, the nitric acid used in the nitration

of free primary amines in sulfuric acid solution must be free from nitric oxide (see page 165). Also, the presence of sulfuric acid in technical hydrochloric acid may cause difficulties in the diazotization of amines which form difficultly soluble sulfates. In still another example, if chlorate is present in the caustic alkali used for alkali fusion, undesired oxidation or even an explosion may result. In all such instances, it is essential to use products which are free from the deleterious impurities. It should also be pointed out that certain substances deteriorate on long standing. This occurs with materials which are strongly hygroscopic (e.g., oleum and chlorosulfonic acid), easily oxidizable (e.g., sulfite and bisulfite), or otherwise easily decomposed (e.g., hypochlorite solutions). In these cases, the compounds must be titrated before use.

In the laboratory, *distilled water* may be used even for technical work, in order to avoid cloudiness caused by the separation of calcium salts. Before a procedure is adapted for large scale operation, however, it must be established that tap water has no harmful effect. Water may be very injurious when present as an impurity in organic liquids, as in the chlorination of nitrobenzene (page 117), and in these cases, careful drying is necessary. With high-boiling liquids, the drying may be accomplished by distillation, discarding the forerun.

The presence of impurities in the *organic starting material* is generally much more injurious than their presence in the inorganic chemicals. Frequently, only very small amounts of a contaminating material may produce an appreciable lowering of the yield or a marked decrease in the purity of the end product. Therefore, the organic chemical industry has gone to considerable lengths to prepare their intermediates in as pure a form as possible. Considerable progress along this line has been made in recent times, so that today many intermediates are available in almost chemically pure form. This is especially true for those substances which are purified by distillation or vacuum distillation. On the other hand, all materials which must be isolated by a salting-out process naturally and unavoidably contain some inorganic salts. This salt is harmless for the great majority of applications, but of course it must be taken into account in determining the quantities to be used. Therefore, it is necessary to determine the purity of all salt-containing starting materials. Primary amines can be titrated with nitrite solution, and compounds which undergo diazo coupling can be analyzed by titration with a diazonium compound. With other materials, other suitable methods are used (see Analytical Section).

The beginner is usually greatly impressed by the strong color exhibited by technical products which should be colorless when completely pure. As a rule, this color has no significance for industrial use,

unless it is exceptionally strong, indicating decomposition or oxidation, and then purification may be necessary. Still more serious, however, is contamination by isomers or closely related compounds whose presence is not so easily discernible, for example, monosulfonic acid in disulfonic acids, or vice versa. Similarly, *m*-phenylenediamine, which contains only a few per cent of the ortho and para isomers, gives azo dyes in much lower yield and purity than the pure meta compound. The impure material is also much less stable (see pages 112 and 116). The methods used for testing the organic starting materials for purity, and for purifying them, are the same as those described later for end products (see page 40 ff.).

Proportions and Weighing

In the organic industrial laboratory the work is almost always done with *molecular quantities*. Calculations are thus greatly simplified. One-tenth of a gram molecule, or with large molecules one-twentieth, is the commonly used unit in the preparation of end products. This quantity gives enough of the product for the first tests of a dye and its dyeing characteristics. Using this quantity, it is also possible to determine the yield sufficiently accurately, provided that the weighing is done to 0.1 gram, an accuracy possible with an ordinary pan balance. Smaller amounts (0.01 to 0.02 mole) may be used for more qualitative experiments. Starting materials or intermediates, which are to be used in a number of experiments, are usually prepared in quantities of one or two moles. With these amounts, weighing to one gram is sufficiently accurate. The technical chemist should become accustomed from the start to weighing or measuring *all* substances used, even in neutralizations, etc., instead of simply pouring them out of stock bottles. The quantities used should be recorded in his laboratory notebook, because this information is very necessary if the experiment is to be repeated later.

Many reactions are favored by an excess of one of the reactants, but very often the use of exact stoichiometric quantities is necessary. When a series of experiments is to be carried out, it may be desirable to prepare the required reagents in solutions, containing, for example, one mole in 100, 200, 500, or 1000 cc. In experiments which require special equipment available only in large size, the quantities taken are, of course, adapted to the capacity of the apparatus.

When hydrated, salt-containing, moist, or otherwise impure starting materials are used, their purity must be determined. Some of the usable methods are described in the Analytical Section. The results of such a determination may suitably be expressed, not as per cent, but as the

quantity (M) of the raw material containing one mole of the pure substance. Thus, a value of M of 382 for technical H acid means that 382 grams of the technical material contains one mole of active H acid. Then one knows, without any calculation, that 38.2 grams must be used in an experiment calling for 0.1 mole of H acid, and this quantity is the same whether the technical sample is the free acid or one of its salts, and whether the product is a hydrate or not.

Laboratory Journals and Reports

It is imperative for the technical chemist to keep an accurate record of all his experiments, and the student should become accustomed to recording all of the work he performs in his laboratory notebook. He should not write up the directions he followed, but should describe the procedure he *actually used* in sufficient detail so that he later can repeat the experiment exactly on the basis of his notes, without introducing any new conditions. It is necessary, therefore, to make an accurate record of quantities used, the temperature maintained, and the reaction time, as well as the nature and size of the apparatus. The notes should also include observations made during the course of the reaction, such as the appearance or disappearance of a color or of a precipitate, liberation of gas, spontaneous increase in temperature, etc. It should also be noted how the rate of the reaction was controlled, how its completion was determined, how the purity of the product was established, etc.

When a project has been completed, a report should be written, summarizing the results obtained and describing the most successful methods found. The description should be complete enough so that any chemist could use it as a basis for repeating the experiment exactly.

Apparatus

At one time, the school laboratories of industrial chemistry sought to train students to use the most primitive sorts of apparatus, put together by themselves from the simplest parts. The modern viewpoint is to use not the simplest, but the most suitable, equipment — that which conserves time and effort. To be sure, the simpler of two equally serviceable apparatus should be given preference, and unnecessary complications — the cost of which is out of proportion to their advantage — should be avoided. Nevertheless, it is still desirable for the technical chemist to be able to operate, in an emergency, with the simplest materials. It is worthwhile, for example, for him to have some proficiency in glassblowing so that he can prepare simple equipment from glass tubing.

Stirring Apparatus

In many reactions involved in industrial organic chemistry, continuous, vigorous stirring of the reaction mixture is absolutely essential for good results. This is especially true if some of the reactants are not in solution in the reaction medium, but are only suspended, in either solid or liquid form. Also, when a precipitate is formed during a reaction, stirring is beneficial because it promotes crystallization and prevents the formation of supersaturated solutions which might solidify all at once. Good stirring is necessary even in homogeneous systems if one of the reactants decomposes slowly. Here the unstable compound must be distributed uniformly throughout the whole mass and high local concentrations must be avoided. Stirring is also especially important for strongly exothermic reactions, such as nitrations, where a local excess of the reagent may cause a violent reaction or even an explosion.

Since most organic reactions require a long time, stirring by hand, which often suffices in the analytical laboratory, is usually excluded and mechanical stirring devices must be used. In the laboratory, these mechanical stirrers may be driven by small water turbines, provided that a water pressure of at least two atmospheres is available. An electric motor is used when greater power is needed, as for example, for driving high speed stirrers in reductions, or for stirrers in autoclaves. Sometimes it may be advantageous to have a long power shaft so that several apparatus can be operated simultaneously.

The form of the stirrer itself depends on the nature of the reaction mixture and on the shape and construction of the container in which the stirrer operates.

Naturally, it is most convenient to use open containers, such as beakers, enameled crocks, open kettles, etc., but these cannot be used if an appreciable loss of a substance or a solvent is to be expected. Open vessels are unsuitable also for reactions which generate vapors which must be absorbed or led to the drain because of their poisonous nature, inflammability, or bad odor. In this connection, it should be noted that many of the intermediates used in the organic industry are strongly poisonous and may be absorbed into the body not only through the stomach, but also through the skin, and, as dust or vapor, through the lungs. Examples of some of these compounds are nitrobenzene, aniline, dinitrobenzene, dinitrochlorobenzene, nitroaniline, and phenol. Of course, open containers cannot be used in cases where air must be excluded because of the deleterious action of oxygen or of the moisture or carbon dioxide in the air.

When an open vessel cannot be used for any of the above reasons,

recourse is had to a covered kettle or round-bottomed flask — often with three or five necks — which is provided with a reflux condenser or an air condenser, or is connected with an absorption flask to absorb poisonous or irritating vapors. An efficient hood will usually suffice to remove small amounts of gases generated. Except when work is to be done under pressure, a “closed” apparatus must be provided with an opening for pressure equalization. This opening, if necessary, can be protected with a calcium chloride or soda lime tube to remove moisture or carbon dioxide, but it is often sufficient to restrict the entrance of air by means of a capillary tube or a plug of glass wool.

Regarding container materials, it is to be noted that only metal containers can be used for the Béchamp iron reduction in weakly acid solution, for alkali or polysulfide fusions, or for operations under high pressure. Pressure reactions involving very small quantities of materials can be carried out in sealed tubes, however. Except for these applications, metal is used only for apparatus of more than six- or eight-liter capacity. Glass containers are generally satisfactory for all other uses, especially since Pyrex and similar glasses are mechanically strong materials resistant to temperature changes and chemical action. Also, they are suitable for the preparation of three- or five-necked flasks or more complicated apparatus.

The use of transparent glass apparatus in the laboratory has the great advantage that the reaction can be observed throughout its course. This is a particularly important factor when a reaction is being run for the first time. On the other hand, it is worthwhile for the technical chemist to become accustomed in the laboratory to working with non-transparent apparatus modelled after plant equipment and to controlling the course of the reaction by removing test samples, just as it must be done on a large scale.

In school laboratories, it is customary to use bent glass rods as stirrers, similar to those shown in Figure 19 (page 101) and Figure 20 (page 105). These stirrers, which are easily prepared by the individual, are quite suitable for mobile liquids, but are not satisfactory for pasty mixtures. With the latter, stirrers presenting more flat surface must be used. One form frequently used in open containers in industrial laboratories consists of a rectangular plate of thick, ribbed glass held in position in a forked holder by two setscrews. These stirrers are easy to keep clean and give a vigorous stirring which can be regulated by changing the angle at which the blade is set. They are, however, quite fragile.

Stirring paddles of porcelain, recently introduced, are less fragile and very satisfactory. They are simply attached to a bent glass rod and are available in various shapes and sizes (Fig. 1a-c).

A propeller-type stirrer is of value for stirring up mixtures containing heavy solids such as iron powder or zinc dust. Such stirrers, an example of which is shown in Figure 17 (page 94), should reach to the bottom. Anchor- or paddle-type stirrers are also useful under these conditions.

Closed reaction kettles, as a rule, have their stirrers built in, usually of the anchor-type which reach nearly to the bottom and sides of the kettle.

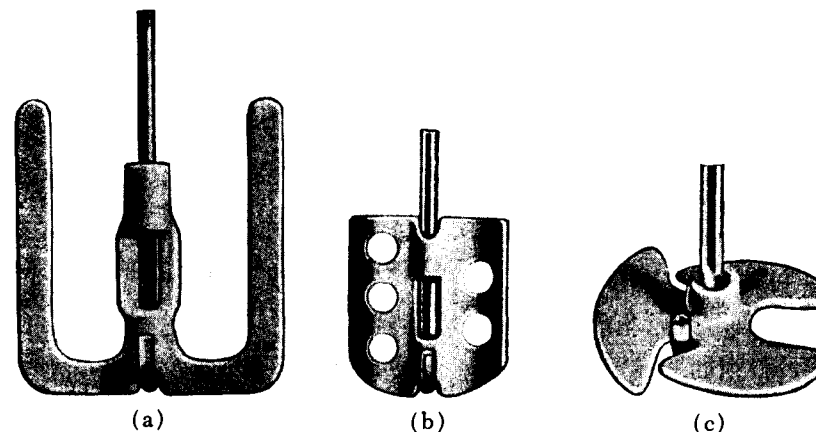

Fig. 1. Porcelain stirrers for attaching to a bent glass rod.

It is difficult to get efficient stirring in a glass flask (round-bottomed or three-necked flasks, etc.) because the relatively narrow neck prevents the introduction of a sufficiently broad stirrer. Special types of stirrers have been devised for this purpose in order to achieve vigorous stirring with a stirrer of small diameter. Propeller stirrers (Fig. 6a) centrifugal stirrer, and others, belong to this group. All of them give vigorous stirring at high speed as long as the mixture being stirred is a homogeneous, mobile liquid, but they fail in viscous or pasty mixtures. With the latter, the best results are usually obtained with a simple glass paddle (Fig. 6b) which can be made by pressing out a rolled-up glass spiral.

It should be pointed out that effective stirring is not possible if the container is too full. In open containers of large diameter, such as dishes or flat vessels, the stirrer may set up waves which are thrown over the edge. To prevent this spilling, a “wave-breaker” must be installed, generally consisting of a vertical, thick glass rod near the edge of the container. For the construction and use of autoclaves, see Section M, page 350 ff.

Filtration

The precipitates commonly encountered in the analytical laboratory are practically insoluble and can be washed with unlimited quantities of liquid. Organic products, on the other hand, are usually more or less easily soluble in the solvent employed, and hence it is always necessary to use the smallest possible amount of wash liquid which will completely remove the adhering mother liquor. For this reason, gravity filtration is of little value. Instead, filtration methods must be used which provide an appreciable pressure difference above and below the filter. This pressure difference is obtained by applying pressure above the filter, or suction below it.

The first method is preferred in plant operations, employing the filter press, in which pressure is supplied by compressed air (see Section L, page 348 ff.). The filter press is not applicable to operations on a laboratory scale.

On the other hand, the filter centrifuge, in which the pressure is supplied by centrifugal force, is well adapted for use with the quantities usually encountered in industrial laboratory operations. The filter centrifuge consists of a metal or porcelain "basket," closed at the bottom and open at the top, bearing sieve-like perforations around its periphery. This basket is mounted in such a way that it can be rotated at high speed within a surrounding shell serving to collect the liquid thrown out. For filtration purposes, the inside of the basket is lined with a suitable filter cloth. When the basket is rotated at a sufficiently high speed, the entrained liquid is expelled, and the precipitated material is obtained in a nearly dry condition. However, the filter centrifuge is suitable only for the filtration of coarsely granular substances, since a fine precipitate either goes through the filter or packs into a dense mass through which the liquid cannot pass. Similar difficulties are encountered with substances which crystallize in plates. All in all, the number of industrial organic products which can profitably be centrifuged is not large. The most useful application of the centrifuge is in the separation of a mixture of isomers, one of which crystallizes from the liquid mixture on cooling (see, e.g., *o*- and *p*-nitrochlorobenzenes, page 90).

The filter centrifuge should not be confused with the sedimentation centrifuge widely used in biochemical laboratories. With a sedimentation centrifuge, fine precipitates are not filtered, but are pressed against the walls of the container and thus separated from the liquid.

The other method of obtaining a pressure difference, namely, suction applied below the filter, can be used in the plant only for well

crystallized, granular precipitates. Here, a fairly deep column of liquid must be used, and the filtration becomes exceedingly slow if the precipitate is very fine. In laboratory operations, where the layer being filtered may not be more than a few centimeters deep, the suction filter is of more general application. Even here, however, failures are encountered when soft, tarry, or gelatinous products are involved or when very finely crystalline materials are filtered. The latter first go through the filter and later stop it up. Difficulties are also encountered with plate-like crystalline materials which press down on the filter to form an impermeable mass. Some of these difficulties may be remedied by using a large filter so that the layer of liquid in it is quite shallow. It is also of assistance to maintain only a weak suction when the suspension is poured into the filter and to stir the material constantly to keep the precipitate from settling.

For granular precipitates, filter cloth is used as the filter material, and for finer precipitates, filter paper. If the precipitate is very fine and has a tendency to go through the filter paper, two or three thicknesses of paper may be used, or, in some cases, hardened filter paper may be employed. It is recommended that both a filter cloth and a filter paper be used in the larger suction funnels to prevent tearing the paper and to facilitate the removal of the precipitate from the filter. The cloth and paper filters should be of exactly the same size as the bottom of the funnel. If they extend up the side wall of the funnel, wrinkles are formed which permit some the precipitate to escape into the filtrate. Wool felt may be used for filtering strongly acid liquids which attack paper and cotton. Still more suitable, and usable even with concentrated acids, are the sintered glass funnels recently made available commercially in a variety of pore sizes.

In order to achieve efficient washing of the precipitate with the least possible amount of liquid, it is important that the mother liquor held in the filter cake be removed as completely as possible before each addition of wash liquid. After the main bulk of the filtrate has run through, the filter cake is stirred and pressed together with a spatula to pack down the individual particles and produce a cake without cracks. Then the cake is pressed down strongly with a pestle or inverted glass stopper until no more drops of filtrate are obtained. The vacuum is then interrupted and the wash liquid poured onto the filter cake, allowing the sponge-like cake to soak up the liquid. Suction is again applied and the cake is again pressed out. The operations of adding and sucking off small portions of the wash liquid are repeated until the impurities have been removed to the required extent. The success of the washing de-

depends on the choice of a filter funnel of the correct size. The filter cake should not fill the funnel but enough space should be left above it to hold the wash liquid. On the other hand, the use of a funnel which is too large gives a thin filter cake, and an excessive amount of wash liquid is required. Also, the formation of cracks and holes in the filter cake is hard to avoid.

Precipitates, which are so finely crystalline that they go through the suction filter or clog it, are filtered most satisfactorily through a large fluted filter. In this case, since the precipitate retains a large amount of liquid, the filter and its contents, after washing, are spread out evenly on a thick absorbent layer of cheap filter paper, for example. The precipitate is separated from the filter without difficulty when enough liquid has been absorbed so that the residue has a pasty consistency, and the large amount of mother liquor still retained is removed in the screw press (Fig. 21). The precipitate is first wrapped in an ordinary filter cloth, then in a thick "press cloth" which can withstand the pressure of the press. Pressing is carried out slowly, with only slight pressure at first. The liquid must have time to make its way through the precipitate and the filter cloths, otherwise the hydrostatic pressure may become great enough to tear the cloth or force the precipitate through it. Only toward the end of the operation, when only a little liquid is present, is full pressure applied.

Filtration of amorphous, soft, flocculent, or gelatinous precipitates offers great difficulty. With these materials, the best results are often obtained by the use of a filter cloth, folded in the same manner that a filter paper is formed into a 60-degree cone, and placed in an ordinary glass funnel. The precipitate can be pressed out right in the filter cloth, carrying out the operation slowly and carefully.

Filtration of warm mixtures always proceeds more rapidly than the filtration of cold mixtures, because the viscosity is lower at higher temperatures. Hence, warm filtration is to be preferred if the stability of the material and the solubility relations are favorable.

In general, the filtering properties depend, in large measure, on the physical properties of the precipitate, and these in turn depend on the precipitation or crystallization conditions. It is often advantageous to carry out a precipitation or crystallization at elevated temperature and with stirring. Frequently, it is beneficial to add salts, or to maintain a certain degree of acidity or alkalinity. In other cases, separation of the precipitates takes place best in an exactly neutral medium. The conditions vary so greatly in individual instances that no general rules can be set up.

Distillation

Distillation, if it is applicable, is the least expensive method for isolating and purifying a reaction product. It is especially useful for: (a) removal of solvents, (b) purification of an already nearly pure reaction product (rectification), and, (c) separation of several reaction products of different boiling points (fractional distillation).

According to the type of procedure, distillations are classified as: (1) distillation under ordinary pressure, (2) distillation under reduced pressure (vacuum distillation), or (3) distillation with steam.

1. Distillation under Ordinary Pressure

Distilling Off Solvents. In general, the solvent has a much lower boiling point than the product to be separated from it, and therefore a fractionating device is usually not required. There are, however, some substances which are volatile with steam and which are also carried over with the vapors of lower boiling solvents. In these cases, it is recommended that a simple fractionating head be used, e.g., a Hempel column filled with glass beads. The form of the distillation flask is of no consequence and frequently the solvent can be distilled out of the same container from which the main product is to be rectified later. For this purpose, the use of an unduly large flask can be avoided by first putting only a portion of the liquid into the flask, and adding more from a dropping funnel from time to time as the distillation proceeds. If the distillation residue is a solid at ordinary temperatures, its removal is facilitated if a wide-mouthed distillation vessel is used.

A steam bath or an electrically heated water bath is used as the heat source for the distillation of low boiling solvents, particularly those which are inflammable, such as alcohol, benzene, and especially ether. Larger quantities of these solvents should always be distilled in a special "ether room" in which the use of open flames is prohibited. If it is necessary to distill ether or the like on a water bath heated with an open gas flame, a closed receiver is used, connected tightly on one side to the condenser and on the other to a tube leading to the floor. In this way, uncondensed ether vapor is prevented from accumulating on the table top in the vicinity of the flame. Solvents which boil over 100°C. are usually distilled using an oil bath in which the oil is heated 20–30° higher than the boiling point of the solvent. Solvents with very high boiling points, such as nitrobenzene, are suitably distilled in vacuum, or steam distilled.

A solution which may have taken up some water is *dried before*

distilling off the solvent. The drying is accomplished by letting the solution stand for a few hours, or better, overnight, over one of the common drying agents (calcium chloride, zinc chloride, sodium sulfate, potassium carbonate, sodium hydroxide, potassium hydroxide, calcium oxide, etc.). A drying agent is selected which will not dissolve in the solvent or react in any way with the product present. Thus, calcium chloride or zinc chloride are unsuitable for use with amines, as are potassium carbonate or potassium hydroxide for use with acids. Sodium sulfate is indifferent and can almost always be used, but it should be freshly dehydrated in order to have good drying activity. Before distilling off the solvent, the drying agent is filtered off because, on warming, the absorbed water may be set free again.

When liquids are heated in smooth-walled containers, such as glass, boiling may be delayed until finally a sudden, violent boiling-up occurs. This "bumping" may blow out the stopper or throw some of the liquid over into the condenser, and cause not only a loss of material but also a fire in some cases. These difficulties are avoided by adding boiling stones (pieces of clay or pumice about the size of a pea) or boiling rods (wooden sticks about the thickness of a match which are placed upright in the flask and which extend up into the neck), not only in distillations, but also when boiling under reflux. The wooden rods have the advantage that they can be removed easily at the end of the distillation when crystallization of the residue is expected, but of course they are useful only with liquids which do not attack wood.

A spiral condenser is best for use with low boiling solvents since it gives very efficient cooling and occupies little space. If a spiral condenser is not available, a long, straight condenser, inclined downward, may be used satisfactorily. An ordinary Liebig condenser may be used for substances of somewhat higher boiling point, and for still higher boiling solvents, a simple air-cooled condenser is best.

The connection between the condenser and the flask should be made with a rubber stopper in most cases. However, it should be noted that many solvents attack rubber (benzene, ligroin, etc.), not only causing damage to the stopper, but also introducing impurities into the materials. In such cases, it is preferable to use cork stoppers which have been carefully rolled before boring. If the vapors attack both cork and rubber, the use of an apparatus with ground glass joints is necessary.

If water is the solvent, it is generally removed by evaporation rather than by distillation unless products are present which are volatile with steam. Evaporation should be done with constant stirring. The process can be accelerated still more by removing the steam rapidly by means

of an air stream. For this purpose, one can set up a wooden propeller to rotate over the surface of the liquid in a porcelain dish or the like, or, when the evaporation is being done in a beaker or similar container, an air stream can be blown or drawn through a glass tube with its open end near the liquid surface. Any of these methods will permit rapid evaporation, without boiling, at temperatures from 80 to 90°C. Such procedures should obviously not be used if the solution contains an easily oxidizable substance. If this is the case, evaporation should be done under vacuum.

Rectification. This process usually involves substances with high boiling points, so that intensive cooling is not necessary. A fractionating flask with a long side arm is best suited for use as the distillation flask because, with this, contact between the vapor and the rubber or cork stopper is minimized. The long side arm affords sufficient cooling in many cases, but if necessary a Liebig condenser or an air condenser can be attached, or a small jacket for water cooling can be installed on the side arm itself. If the distillate solidifies, the receiver should be cooled and the distilling flask should have a wide, somewhat shorter, side arm which does not clog so easily. Substances with very high boiling points should be distilled from flasks having the side arm attached close to the bulb of the flask, so that severe overheating of the vapor is not necessary.

A thermometer is always used in rectification. It should be placed so that the upper edge of the thermometer bulb is exactly opposite to the opening into the side arm. No other arrangement will give the correct temperature of the vapor going over. Regarding thermometer corrections, see the later section on testing the purity of products (page 41).

The portion of distillate coming over below the correct boiling point (remainder of solvent, unchanged starting material, etc.) is collected separately as the "forerun." Any water which is present should be removed carefully before rectification, if not before distilling off the solvent, because water frequently delays the attainment of a sharp boiling point. The main fraction should come over within a temperature range of one degree. Any portion that distills over beyond this range of the main fraction is collected as the "afterrun," which can often be redistilled to yield more of the pure material.

An oil bath is usually used for heating the distilling flask, and is to be recommended particularly for cases where an appreciable amount of residue remains at the end of the distillation, because excessive heating of such residues should be avoided. In other cases, the distilling

flask can be heated carefully with a free flame, or a hot air funnel can be employed.

Fractional Distillation. It is not possible to effect, by means of simple distillation, a separation of several products whose boiling points are not greatly different. In such cases, a fractionating tube, or fractionating column, must be used. The action of a fractionating column depends on the fact that the vapors ascending from the flask are in constant contact with the liquid mixture, causing the higher boiling constituents to be condensed and thus held back, while permitting the lower boiling substances to proceed into the condenser. This action takes place to a certain extent even when the vapors are passed through a long empty tube in which some condensation occurs on the side walls. The effect is greatly improved if the tube is alternately constricted and enlarged, or better, if the tube walls are indented with points, so that the partial condensation is favored and the contact area between vapor and liquid is increased. An apparatus of this type is quite suitable for the separation of substances whose boiling points do not lie too close together. It is of little use, however, if the boiling point difference is only a few degrees, as is the case with most mixtures of isomers. When this is the case, the contact surface between vapor and liquid must be increased still more by filling the column with a suitable packing. Raschig rings make a good packing. They are cylindrical rings of almost any material — usually glass for laboratory purposes — whose height is equal to their diameter, and which are put into the column in random orientation. In addition, the quantity of liquid flowing back through the column must be regulated by the use of a partial condenser installed in the top of the column. The partial condenser is constructed so that its cooling action can be regulated, while the rest of the column is insulated to prevent heat loss. The partial condenser can be cooled to a point depending on the boiling point of the substance, using water or other liquid, or air (see Fig. 37). The greater the proportion of the vapor condensed by the partial condenser, the more complete will be the separation of the components in the mixture, and, of course, the greater will be the length of time required for the distillation. The heating should always be uniform for fractional distillations, and the use of a water bath, an oil bath, or a graphite bath is recommended, the choice depending on the boiling point of the mixture.

With an efficient fractionating column, almost complete separation, for example, of a mixture of benzene, monochlorobenzene, and dichlorobenzene, can be achieved on a laboratory scale (see page 64). On the other hand, the isomeric dichlorobenzenes, whose boiling points differ

by only four or five degrees, cannot be separated completely, even on a large scale. In some cases involving liquid mixtures of isomers which are solids in the pure state, good separation is obtained by careful fractionation. The first and last fractions, each containing predominantly one or the other of the isomers, are cooled, whereupon the pure isomers are crystallized. The crystals are then separated from the residual liquid by centrifuging, the liquid residues being returned to the process (see the separation of 2,4- and 2,6-nitrochlorotoluenes, page 160).

2. Vacuum Distillation

This subject is discussed in the section entitled "Vacuum Distillation in the Laboratory and Plant" (page 341).

3. Steam Distillation

Distillation with steam in plant operations is a relatively expensive process because it requires large volumes of steam and cooling water. For laboratory work, however, it is a very suitable method for the smooth separation of organic products, which are volatile with steam, from non-volatile inorganic impurities and high molecular tarry by-products. The separation of isomers is also possible in those instances where only one of the isomers is volatile with steam (e.g., *o*- and *p*-nitrophenols, page 147). Volatile acids and basic compounds can be separated from each other, and from neutral products, by successive steam distillations from acid and alkaline solution.

If the steam is taken from a steam line, it is advisable to insert, between the line and the distillation flask, a safety flask fitted with a vertical tube. This safety flask serves both to collect the condensed water carried along with the steam and to permit control of the pressure (2, in Fig. 23a, page 141). If the steam is produced in the laboratory, the steam kettle is provided with a safety tube.

A long-necked round-bottomed flask is most suitable for the distillation flask. It is mounted at an angle so that the liquid thrown up when steam is introduced hits the side of the flask and not its neck. (The tubulated receivers formerly used in distillation from retorts are especially suitable. The tube serves for introducing the steam, and the neck for taking off the distillate.) The tube through which the steam enters should extend to the bottom of the distillation flask. The tube carrying the distillate to the condenser should be wide and beveled at the bottom, so that drops of the liquid are not carried over into the condenser, but run back into the flask. The flask should not be more than one third

full, so that the liquid is prevented from bumping or foaming over. If for any reason the distillation flask must be set upright, or if a kettle must be used, then it is essential that the delivery tube be provided with a trap to catch entrained liquid. The distillation flask should be heated during a steam distillation or it will collect too large a volume of water. A hot air bath is a good method of heating for this purpose.

Since the heat of vaporization of water is very large, intensive cooling is required if a steam distillation is to be done at a rapid rate. In distilling materials which are liquid at room temperature, it is advisable to use two water cooled condensers arranged one after the other. For the distillation of materials which solidify, only one water cooled condenser is used, possibly in conjunction with an air cooled condenser. These condensers should be thin-walled and have wide inner tubes *not tapered at the end*. Any solid distillate forming in the condenser can be remelted by occasionally interrupting the flow of cooling water. It may also be possible to run the condenser warm enough to prevent solidification of the distillate, and to use as a receiver a round-bottomed flask cooled by a stream of water. For distilling high melting materials which unavoidably solidify in the condenser, one can only use a straight wide condenser which is equipped with a suitably bent, thick wire, or glass, push-rod (cf. 6 in Figure 23a, and 5 in Figure 23b, page 141).

Considerable quantities of volatile materials may be occluded and held back if a large amount of tarry material separates out in the distillation flask. In such cases, it is advisable to remove the tar after it has cooled, break it up as finely as possible, then return it to the flask for further distillation.

Separation of a mixture of substances by fractional steam distillation is not possible to any degree unless the difference in volatilities with steam is very large. Sometimes it is possible to separate compounds differing in basicity or acidity. For example, a mixture of amines may be subjected first to steam distillation from a solution which is quite strongly acid, to distill out the least basic amine. Then the mixture is made less acidic and the distillation is continued to remove an amine which is somewhat more basic than the first one. Finally, distillation from neutral or alkaline solution is carried out to carry over the most strongly basic compound.

The distillation of compounds which are only slightly volatile with steam can be accelerated appreciably by superheating the steam. Of course, nothing would be gained by introducing superheated steam into an aqueous solution or suspension, since a temperature above the boiling point of the mixture could not be attained in any case. Hence, the

substance to be distilled must be used in the dry state, or if water is present, this must be removed previously. The distillation flask is heated to the same temperature as the steam, preferably with an oil bath. Where strong superheating is used, the connection between the steam heater and the tube through which the steam enters the flask cannot be made with rubber tubing. Only cork, or metal packed with asbestos, should be used.

Separation of Reaction Products

Confronted with the isolation of an organic compound which has either acidic or basic properties, and which therefore forms salts, the beginner is often in doubt as to whether the compound should be isolated in its free state or in the form of one of its salts. Since the literature frequently contains little helpful information on this point, it will be taken up here at some length in connection with the general problem of the most suitable methods for isolating compounds of various types.

Basic Substances

The aliphatic amines are, in general, volatile liquids soluble in water. They are strong bases which turn litmus blue, and react with mineral acids to form neutral salts. The reaction to litmus — apart from the physical form — shows immediately whether the base or a salt is at hand. For the isolation and identification of aliphatic amines, the salts formed with picric acid and similar acids are of value. These salts are usually nicely crystalline and have characteristic melting points.

The aromatic amines, which are much more important technically, have quite different properties. Let us take the simplest compound of the series, aniline, as an example. Free aniline is only slightly soluble in water, about 3 per cent. The aqueous solution does not turn litmus blue; therefore aniline is a weak base. Aniline gives easily soluble salts with strong mineral acids — hydrochloric, sulfuric, and nitric. Solutions of these salts react strongly acid to litmus; hence, the salts are hydrolyzed in solution, but not sufficiently to cause free aniline to precipitate. The hydrogen ion concentration of these salt solutions is not high enough to turn Congo red paper blue. Congo red paper can be used, therefore, to determine the presence of free mineral acids over that required for salt formation. Evaporation of a solution of an aniline salt

yields the unchanged salt. It follows that if a precipitate forms, or crystallization occurs, in an aniline salt solution which reacts acid to Congo red, then the separated material must be a salt of aniline and not the free base. A separation such as this may occur, for example, when a concentrated solution of aniline hydrochloride is treated with sodium sulfate, because aniline sulfate is considerably less soluble than the hydrochloride. Precipitation occurs also when concentrated hydrochloric acid is added to the aniline hydrochloride solution, because the salt is much less soluble in strong hydrochloric acid than it is in water. Precipitation is especially easily accomplished with the alkali metal salts of sulfonic acids (e.g., sodium naphthalenesulfonate), which often form difficultly soluble salts with aromatic amines. With aniline itself, of course, there is no difficulty in telling whether a precipitate consists of the free base or of a salt, because the former is a liquid at ordinary temperatures and the latter a solid. With solid amines, on the other hand, the appearance of the precipitate is not a sufficient indication.

Aniline does not give water-stable salts with weak acids like acetic acid. Some aromatic amines do give crystalline acetates with acetic acid, but these are decomposed by water with separation of the free base. This property is utilized industrially in the isolation of *m*-xylydine from a mixture containing its isomers. Hence, free aniline separates out of an aqueous solution of an aniline salt with a mineral acid if the mineral acid anion is replaced by the acetate ion, for example, by the addition of sodium acetate in sufficient concentration.

Homologs of aniline and naphthylamines have properties similar to those of aniline, as do polynuclear compounds which have only one amino group in each nucleus, such as benzidine, diaminodiphenylmethane, and di- and triaminotriphenylmethanes. If two or more amino groups are present in one nucleus, the basicity is somewhat higher, and the water solubility is greatly increased, although the essential character of the compound is not changed. Nuclear substitution products of these amines behave similarly, provided that the substituents have no appreciable effect on the base strength. Alkoxy groups ($-\text{OCH}_3$, $-\text{OC}_2\text{H}_5$, etc.) and acylamino groups ($-\text{NHCOCH}_3$, $-\text{NHCOC}_6\text{H}_5$, etc.) are examples of such indifferent substituents, and hence anisidine, phenetidine, and monoacetyl- and monobenzoyl-*p*-phenylenediamines behave like aniline with respect to salt formation. Also, the introduction of alkyl groups into the amino group effects no appreciable change in salt-forming properties; mono- and dimethylaniline, mono- and diethylaniline, ethylbenzylaniline, etc., are all quite similar to aniline. On the other hand, the introduction of a second aromatic residue into the amino group

completely removes the basicity. Diphenylamine, phenyl-naphthylamine, and the like, and carbazole, do not form salts with aqueous acids. Also, the introduction of certain substituents, called negative or acidic substituents, into the nucleus, lowers the basicity and finally removes it completely. Nitro groups show this effect most strongly, halogens to a smaller extent. Still less effective are the carbonyl groups in aldehydes, ketones, carboxylic esters and amides, etc. The sulfone group acts similarly to the carbonyl group. The azo group is also slightly negative. Not only the nature of the substituent group, but also its position, is an important factor. Groups in the ortho position have the greatest effect, para groups have somewhat less effect, and those in the meta position, much less. Thus, *m*-nitroaniline gives a hydrochloride which is stable in aqueous solution, while a concentration of hydrochloric acid of at least 10 per cent is necessary to prevent hydrolysis of *p*-nitroaniline hydrochloride. *o*-Nitroaniline forms a hydrochloride only with concentrated hydrochloric acid; the addition of only a small amount of water precipitates the free base. Dinitroanilines give no salts with aqueous acids, and neither do trichloroaniline and dichloronitroaniline. With aminoanthraquinones, the two carbonyl groups lower the basicity of the amino group to such an extent that 75–80 per cent sulfuric acid is necessary for salt formation; the free base separates from more dilute acids.

Amines having strongly negative substituents, therefore, may separate as the free base from solutions which react strongly acid to Congo red. With colored compounds, the color usually shows whether the free base or a salt has separated. For example, the nitrated amines are deep yellow but their salts are colorless. Similarly, the salts of aminoanthraquinones are colorless, while the free bases are orange to red. With aminoazo compounds, salt formation is accompanied by a color change from yellow to red, or from orange to violet. Nitrosated amines, such as *p*-nitrosodimethylaniline, are green and their salts are yellow. With colorless compounds, the character of the precipitate is most easily recognized by its behavior toward indifferent solvents, such as ether or benzene. The free bases are usually quite easily soluble in these solvents while the salts are insoluble.

It is to be noted that diazo compounds are much more strongly basic than the amines from which they are derived. A solution of diazotized *p*-nitroaniline, for example, can be diluted with water to any desired extent, or even neutralized with acetate, without setting the diazonium base free. The stability of the diazonium compound is much less under these conditions, however, than in strongly acid solution.

Acidic Substances

The acidic compounds, which react with bases to form salts, may be divided into three main groups: phenols, carboxylic acids, and sulfonic acids.

The phenols correspond to the aromatic amines. With caustic alkalis, they give salts which are soluble in water without visible decomposition. Solutions of these salts, however, give a strongly alkaline reaction to litmus and are decomposed, with liberation of the free phenol, by the weakest acids, such as CO_2 or SO_2 . The salts give a neutral reaction to thiazole paper or auramine paper, and if there is present an excess of alkali over that required for salt formation, thiazole paper is turned red and auramine paper is decolorized. Hence, if the solution reacts alkaline to these indicators, only the phenol salt will be obtained by evaporation or salting out. Analogous to the behavior of aromatic amines with acetic acid, the phenols do not form water-stable salts with ammonia. Aqueous solutions of phenol salts, therefore, can be treated with an ammonium salt to set the phenol free, and to precipitate it if the salt concentration is high enough.

Negative substituents enhance the acidic properties of phenols, an effect opposite to that produced with aromatic amines. *o*- and *p*-Chlorophenols are considerably stronger acids than phenol itself, and *o*- and *p*-nitrophenols are still stronger. Trinitrophenol, picric acid, is a strong acid whose salts are neutral and not decomposed by carbonic acid or by ammonium salts. These salts of picric acid can be salted out of neutral solutions by sodium or potassium chloride. With negatively substituted phenols, it may be possible to separate the phenolate from solutions which are neutral or weakly alkaline to litmus. In doubtful cases, just as with the amines, the precipitated material must be studied to determine whether it is the free phenol or one of its salts. The color of the precipitate gives an indication in the case of the nitrophenols, since the free phenols have only a weak yellow color, whereas the alkali salts are deep yellow. Solubility tests with indifferent solvents may be used in the case of uncolored compounds. Only the free phenol can be separated from acidic solutions.

In aminophenols, the amino and hydroxyl groups retain their individual properties, each group having little influence on the other. It is possible, therefore, under certain conditions to salt out the sodium salt from a solution of the aminophenol containing excess alkali, or the hydrochloride from a solution containing hydrochloric acid. The free aminophenol itself can be separated from neutral, ammoniacal, bicarbonate, or acetic acid solutions.

The carboxylic acids are considerably stronger acids than the phenols. They turn litmus red, and yield alkali metal salts which are neutral to litmus. They do not turn Congo red paper blue, however; at best only a violet coloration is formed. In contrast to the phenols, the carboxylic acids dissolve even in bicarbonate solutions, and very easily in carbonate and ammonia solutions. The free acids are regenerated from their salts by strong mineral acids.

The influence of amino and carboxylic groups on each other, when they are present in the same molecule, is quite small. Anthranilic acid dissolves as easily in carbonate solution as does benzoic acid, and as easily in aqueous hydrochloric acid as does aniline. Hence, an excess of either alkali or mineral acid must carefully be avoided if it is desired to isolate an aminocarboxylic acid in the free state. On the other hand, a slight excess of acetic acid does no harm.

The sulfonic acids make up the third group of acid compounds. These acids play a very important role in industrial chemistry. They are, however, less important in pure research, and therefore are often treated very briefly in textbooks and lectures on organic chemistry. The sulfonic acids behave quite differently from the carboxylic acids. They are as strongly acidic as the mineral acids, such as hydrochloric and sulfuric acids, and therefore are not liberated from their salts by the mineral acids. For example, if a dilute aqueous solution of sodium benzenesulfonate is treated with the equivalent quantity of hydrochloric acid, the solution then merely contains four ions: H^+ , Na^+ , Cl^- , and $\text{C}_6\text{H}_5\text{SO}_3^-$. If the dilution is not sufficiently high to give complete ionization, then the four possible combinations of these ions will be present — HCl , NaCl , $\text{C}_6\text{H}_5\text{SO}_3\text{H}$, and $\text{C}_6\text{H}_5\text{SO}_3\text{Na}$ — all in equilibrium with the four ions. If such a solution is concentrated by evaporation to the point where the solubility limit of one of the four compounds is reached, then the least soluble product begins to separate from the solution. Continued evaporation leads to the exclusive formation of the insoluble compound, or more accurately, of one pair of compounds (e.g., sodium benzenesulfonate and HCl , or benzenesulfonic acid and NaCl). Unfortunately, the solubility relationship determines which compound will separate, and since this relationship varies widely with different sulfonic acids, no theoretical predictions can be made. Experience has shown, however, that the free sulfonic acids are, as a rule, very soluble in water, although often their solubilities are much smaller in strong hydrochloric or sulfuric acid. If, for example, naphthalene is sulfonated with ordinary sulfuric acid at high temperature in such a way that naphthalene- β -sulfonic acid is the chief product (see page 187), and

then the sulfonation mixture is diluted with water (3 parts of water to 4 parts of sulfuric acid) and cooled, the naphthalene- β -sulfonic acid free from by-products⁴ separates almost completely. The sulfonic acid can be purified further by dissolving it in a little water and adding concentrated hydrochloric acid; it is only very slightly soluble in about 10 per cent hydrochloric acid. Procedures such as this are successful, however, only if the solution contains no metal ions. If one starts with a salt of the sulfonic acid, or introduces metal ions into the solution by the addition of common salt or Glauber salt, then the product which separates is the corresponding sulfonate which is usually less soluble than the free sulfonic acid. Thus, if the sulfonation mixture of the foregoing example is poured into a salt solution, instead of diluted with water, a voluminous precipitate of sodium naphthalene- β -sulfonate is formed in spite of the fact that the solution contains a large excess of free sulfuric acid. *It is not possible, as a rule, to transform an alkali metal sulfonate into the free sulfonic acid by treatment with strong mineral acids.* If such a transformation is ever required, the barium salt of the sulfonic acid must be prepared, for example, and this must be treated with the calculated amount of sulfuric acid. The conversion is accomplished quantitatively because the barium is removed as the insoluble barium sulfate. Alternatively, the lead salt may be prepared and then decomposed with hydrogen sulfide to eliminate the metal as insoluble lead sulfide.

With di- and polysulfonic acids, the formation of acid salts is possible, of course, by neutralizing only part of the sulfo groups, and it is conceivable that in some cases these acid salts would be sufficiently insoluble to separate out. However, this is the exception; as a rule, the precipitate formed by salting out consists of the neutral salt, even with polysulfonic acids.

All that has been said above about sulfonic acids holds true only if there are no amino or other basic groups present in the molecule along with the sulfo group. Sulfonic acids with amino groups behave quite differently. As was mentioned earlier, if water solutions of aniline hydrochloride and sodium naphthalenesulfonate are mixed, the difficultly soluble aniline salt of naphthalenesulfonic acid is precipitated. An analogous situation is obtained if the amino and sulfo groups are in the same molecule; an intramolecular equalization of polarity results in the formation of an inner salt. Such inner salts are generally quite insoluble. For example, if an aqueous solution of sodium sulfanilate or sodium naphthionate is acidified with a mineral acid, the inner salt

⁴ Witt, *Ber.*, 48, 750 (1915).

is precipitated almost completely. Usually, these inner salts are not formulated as such, but are referred to as free sulfanilic or naphthionic acid. These so-called free aminosulfonic acids retain the acidic character of the sulfo group; they give an acid reaction to litmus, neutral to Congo red, and they dissolve in alkalis, alkali carbonates, or bicarbonates with the formation of the corresponding salt, just as though the amino group were not present. They also form salts with organic bases, a reaction illustrated by the precipitation of aniline sulfanilate by mixing solutions of sodium sulfanilate and aniline hydrochloride. On the other hand, the basic properties of the amino group are completely absent in the aminosulfonic acids. They do not form salts with even a large excess of mineral acid. *The hydrochloride and sulfate of sulfanilic acid do not exist.* This holds even for strongly basic groups like the diazonium group. When sulfanilic acid is diazotized, for example, the precipitated, difficultly soluble, diazo compound is not the chloride, despite the presence of excess hydrochloric acid, but is the inner salt in which the diazonium group and the sulfo group are mutually neutralized.

With aminosulfonic acids which contain several amino groups, the rule is that each basic group neutralizes one sulfo group, and vice versa. If the same number of amino groups and sulfo groups is present, the properties of the compound are the same as those of the monoaminomonosulfonic acid. Thus, *m*-phenylenediaminedisulfonic acid and benzidinedisulfonic acid show the same behavior as sulfanilic acid. If more amino groups than sulfo groups are present, then the excess amino groups retain their ability to form salts with acids. Thus, *m*-phenylenediaminemonosulfonic acid dissolves in hydrochloric acid just as aniline does. In the separation of these aminosulfonic acids containing excess amino groups, therefore, an excess of mineral acid must be avoided, just as in the case of aminocarboxylic acids, because excess acid would redissolve the product. If the reverse situation exists and the compound contains more sulfo groups than amino groups, acidification of the alkali metal salt will liberate as many sulfo groups as there are amino groups present. The other sulfo groups will retain the metal, behaving generally like the sulfo groups of benzene- and naphthalenesulfonic acids. That is, the free sulfonic acid is formed only in exceptional cases where the solubility relations are favorable. As a rule, an acid salt is precipitated, in which there is one free sulfo group for each amino group, and the remaining sulfo groups are attached to alkali metal atoms. These facts should be noted particularly, because the compounds of this type are usually designated in

industry by the names of the free acids. Thus, S acid, amino G acid, and C acid are actually the monosodium salts of 1-naphthylamine-4,8-disulfonic acid, 2-naphthylamine-6,8-disulfonic acid, and 2-naphthylamine-4,8-disulfonic acid, respectively; the so-called Koch acid is the disodium salt of 1-naphthylamine-3,6,8-trisulfonic acid and H acid is the monosodium salt of 1-amino-8-naphthol-3,6-disulfonic acid. Hydroxyl groups, such as that in the last example, have no significance except that they can be neutralized only in strongly alkaline solution. The basic salts formed in this way are usually much more soluble than the neutral salts, and hence, if it is desired to separate phenol- or naphtholsulfonic acids, conditions should be employed which exclude the possibility of salt formation on the hydroxyl group.

Purification of Products

It was pointed out in an earlier section that distillation in its various forms is generally the cheapest industrial method of purification. It is, of course, applicable only to those substances which can be volatilized without decomposition, and serves a useful purpose only if the impurities or by-products are sufficiently different in boiling point from the product being purified. Substances whose boiling points lie within a narrow range can often be separated sufficiently well for technical purposes by careful fractional distillation, although a complete separation may not be achieved. For example, technical benzene (b.p., 80°C.) cannot be freed, by distillation alone, from the thiophene (b.p., 84°) which is always present as an impurity. Also, technical *o*-nitrotoluene (b.p., 220°) always contains some of the isomeric substances (b.p., 228° to 238°), although the amounts of the isomers present are so small that they do not interfere with the technical use of the product. If very high purity requirements are to be met, it may be necessary to combine distillation with other methods of purification.

Next to distillation, the most important purification method, especially in the laboratory, is recrystallization. In this operation, the substance to be purified is dissolved by heating with a suitable solvent, usually by boiling under reflux, and the hot solution is filtered to remove any undissolved impurities. The clear filtrate is cooled slowly, whereupon most of the main product crystallizes out, leaving the more soluble impurities in solution. If crystallization occurs slowly, it may be hastened by stirring. Some substances tend to form supersaturated solutions, and with these it may be necessary to induce

crystallization by scratching the walls of the container with a glass rod, or by seeding with a few small crystals of the substance. The crystallization can be brought to completion by cooling the solution in ice, or by allowing it to stand in the ice chest. A quantity of the solvent is employed that will dissolve the product when hot (except, of course, for the insoluble impurities) and that will hold the soluble impurities in solution in the cold so far as possible. If the product is quite impure, it may be desirable to wash it, before crystallization, with a cold solvent which is a good solvent for the impurities but which does not easily dissolve the main product. The use of animal charcoal, blood charcoal, activated carbon, or other strong adsorption agents, is often of value for removal of colored or colloidal impurities. The adsorption takes place better from a warm solution than in the cold, and requires some time; hence, the solution should be heated about 30 minutes with the decolorizing agent, then filtered hot. (Alkaline solutions cannot be decolorized with animal charcoal or activated carbon.)

The correct choice of solvent is of the utmost importance in determining the success of a recrystallization. If the literature gives no information on this point, the best solvent must be selected on the basis of test tube experiments. The first requirement, of course, is that the solvent must dissolve the substance more easily when hot than when cold, and it must allow most of the material to crystallize out on cooling. In addition, it should either not dissolve the impurities, so that they can be removed in the hot filtration, or it should dissolve them so easily that they remain in solution and do not crystallize out with the main product. It is not always possible to find a solvent which fulfills these requirements, and it becomes necessary to repeat the crystallization, preferably with a change of solvent. If there are several solvents which are equally suitable, preference is given to the one which has a moderate solvent action on the material. The quantity of material to be purified is another factor to be taken into consideration. If this quantity is quite large, say 200 grams, a fairly active solvent would be selected, so that about 1 liter of solvent, for example, would suffice to dissolve the material when hot. On the other hand, if the same selection of solvent were made in a research experiment where only 0.1 gram of the material was available, then the crystallization would be very difficult to carry out, since only 0.5 cc. solvent would be used. Under these circumstances, it would be better to use a much less active solvent so that a quantity of 5–10 cc. could be used. In cases where one solvent

is too active and others are too inactive, the best results are often obtained by the use of a mixture of solvents, for example, water and alcohol, water and acetic acid, benzene and ligroin, or ether and chloroform. The use of a solvent mixture is resorted to only in necessary cases, because the results obtained are usually less satisfactory than when a single solvent is used. In addition, it is frequently difficult to work up the mother liquors when they contain more than one solvent.

The process of merely dissolving a substance in a solvent and then recovering the material by evaporation of the solvent does not constitute a recrystallization and does not effect a purification except insofar as less soluble impurities are removed by filtration. To be sure, one is frequently compelled to distill off part of the solvent after filtration in order to get full crystallization, but this concentration should never be carried to the point where the more soluble impurities are not really dissolved. Substances which are difficultly soluble can be subjected to a sort of continuous dissolving and crystallization process, known as extraction. The raw product may be extracted with a low boiling solvent in a Soxhlet apparatus, in which the extraction thimble is placed above the extraction flask. For high boiling solvents, the Noll apparatus is used, in which the thimble is suspended in the neck of the flask.

More or less of the substance being purified always remains dissolved in the recrystallization mother liquor, along with the soluble impurities. This material can be recovered by distilling off a part of the solvent, cooling, and filtering off the resulting crystals. The new filtrate can be concentrated again, and the process repeated as long as usable crystals are obtained. These mother liquor products are usually less pure than the first fraction, but they can be purified by subsequent recrystallization.

It should be noted that within a group of solvents having the same general character the solvent action runs parallel to the boiling point. Thus, a substance which dissolves only slightly in boiling benzene (b.p., 80°C.) is usually more soluble in boiling toluene (b.p., 111°), and still more soluble in boiling xylene (b.p., 140°) or chlorobenzene (b.p., 132°). Therefore, one is compelled to use high boiling solvents, such as trichlorobenzene, nitrobenzene, tetralin, aniline, phenol, etc., for recrystallizing very difficultly soluble compounds (frequently, e.g., with anthraquinone derivatives). The high boiling solvents have the advantage that they are good solvents at the boiling point, but poor solvents in the cold, so that the product crystallizes out quite com-

pletely. Unfortunately, the same solubility relations often hold also for the impurities, so that they too are dissolved in the hot solvent and separate on cooling. In such instances, no purification is accomplished. In general, a correctly performed recrystallization is an effective method of purification. It is, however, a rather costly operation on a technical scale, especially if it involves the use of organic solvents which must be recovered. The recovery of solvents is never accomplished without some loss.

For this reason, preference is often given in industrial work to a process which might be called reprecipitation. This can be an effective method of purification if correctly carried out. By reprecipitation is meant the process of dissolving a product in a suitable solvent, either hot or cold, and then precipitating it by the addition of any other component which decreases the solubility. Solution in alcohol and reprecipitation by the addition of a second solvent, such as ether or water, might be taken as an example of this process. In industry, preference is given, for economic reasons, to those reprecipitation procedures which do not require the use of organic solvents, but which operate in purely aqueous media. Such procedures are exemplified by the process used so frequently in purifying sulfonic acids and dyes, consisting of dissolving the material in water and then precipitating it by adding some suitable salt — common salt, sodium sulfate, calcium chloride, ammonium sulfate, etc. Usually, solution of the material is assisted by warming, and, if at all possible, the precipitation is carried out in the warm solution in order to obtain the material in a more coarsely granular form which is easier to filter. If the precipitation is sufficiently complete, the mixture may also be filtered warm; frequently, however, the product does not separate completely unless the mixture is cooled. Stirring during the cooling accelerates the crystallization and makes it more uniform. Unless the solution is clear, it should be filtered before the addition of the precipitating agent, and the latter should be used, if possible, in the form of a clear solution (e.g., a filtered saturated salt solution). In this way, the introduction of new impurities along with the precipitating agent is avoided. The precipitating agent is used in an amount which will precipitate the desired product completely without throwing out the impurities. After the product has separated completely, it is filtered with suction and washed on the funnel with a salt solution of the same concentration present in the mixture after precipitation. Thus, if in the precipitation process, an aqueous solution was mixed with an equal volume of saturated salt solution, then a mixture of equal

volumes of saturated salt solution and water is used for washing the precipitate. In order to remove as much salt from the product as possible, it is often desirable to wash the product again with a somewhat more dilute salt solution, and finally with a very small volume of cold water if the product is not too soluble. In the laboratory, a still further purification of sulfonic acids and their salts can often be achieved by a final washing of the precipitate with alcohol and then with ether. In this way, colored or tarry impurities are frequently removed. Furthermore, the precipitate dries more rapidly and without caking, so that a loose, light-colored product is obtained. Washing with alcohol should never be undertaken until a test has been made to show that the product is not appreciably soluble in alcohol. Most, but not all, sulfonates are sufficiently insoluble in alcohol. Some of them, however, are very easily soluble.

Another reprecipitation method commonly used is applicable to compounds which are difficultly soluble in water, but which form easily soluble salts. These include bases which dissolve in dilute acids and which are thrown out of solution by the addition of alkalis, as well as acidic substances, such as carboxylic acids, sulfonic acids, and phenols, which are dissolved in alkalis and thrown out by the addition of acids. This type of reprecipitation is effective in removing only those impurities which have no basic or acidic properties, and which, therefore, are not dissolved by the acid or alkali and are removed by filtration. Impurities having the same chemical properties as the main product are not removed to any extent by such a process. The effectiveness of the method is greatly increased, however, by two modifications.

The first modification is fractional precipitation. As an example, a basic crude product is dissolved in just the necessary amount of dilute hydrochloric acid. The alkali required to neutralize the acid is not added all at once, but first only a small portion of it, perhaps 5 or 10 per cent, is added, so that any less basic impurities which may be present are precipitated first. These less basic impurities are then filtered off, and on further neutralization of the filtrate an essentially pure base separates. Conversely, if the impurities are more strongly basic than the main product, they begin to precipitate only toward the end of the neutralization. In this case, a pure base is obtained by adding only 80 or 90 per cent of the quantity of alkali required to neutralize the hydrochloric acid. Obviously, the same method can be applied to compounds of an acidic nature. It gives good results where compounds of different basicities or acidities are to be separated, as

is often the case with mixtures of isomers. It was mentioned earlier, for example, that a nuclear ortho or para halogen greatly reduces the basicity of an amino group, but a halogen in the meta position has much less effect. Hence, if a reaction gives a *m*-chlorinated amine as the main product and a small amount of the ortho or para isomer as by-product, the latter can be removed by fractional precipitation.

In the second modification, which is of more general application, the dissolved salt is not transformed into the free base or acid, but is separated as such. Usually this is done, in the case of alkali metal salts of acids, by salting out, as described above. With amine salts, an excess of the acid used in dissolving the amine often effects the salting out. For example, as was pointed out before, aniline hydrochloride is very soluble in water but quite insoluble in concentrated hydrochloric acid. The difference is still greater with other amines. *α*-Naphthylamine hydrochloride, for instance, is almost completely precipitated from its solutions by the addition of only a small excess of hydrochloric acid. Instead of separating the easily soluble salt as such, it may be transformed into a less soluble salt, for example, by changing a hydrochloride into the sulfate, or an alkali metal salt into a barium salt or lead salt, if these are less soluble. Thus, the usual procedure for purifying benzidine is to dissolve the crude base in dilute hydrochloric acid and then precipitate it as the sulfate by adding sodium sulfate. The sulfate of benzidine is practically insoluble and separates completely, while the sulfates of the isomeric bases formed as side products remain in solution. Obviously, the salts precipitated by any of these methods must be filtered off and washed before they are reconverted to the free compounds. In many cases, the salt as such is usable directly. Thus, anthranilic acid can be purified either by dissolving in hydrochloric acid and precipitating its hydrochloride, or by dissolving in sodium carbonate solution and isolating the sodium salt. Compounds purified in this way are usually much more pure than those purified by solution in acid and precipitation with alkali or vice versa. In general, the purity is high enough for practical purposes. In cases where especially high purity is necessary, more complete purification can be accomplished by recrystallizing or reprecipitating the isolated salt before converting it back to the free compound.

A related reprecipitation procedure, particularly valuable with difficultly soluble anthraquinone derivatives, consists in dissolving the crude product, which has weakly basic properties, in *concentrated* sulfuric acid. The acid is then diluted, by careful addition of water, just to the point where the sulfate separates out but is not decomposed

by hydrolysis. Ordinarily, this point is reached when the sulfuric acid content is about 70 or 80 per cent. The precipitated sulfate is filtered off on a sintered glass funnel and washed with acid of the same concentration, and then finally converted back to the free base by stirring with a large volume of water.

In addition to those described, there are many other methods for purifying organic compounds. Examples which might be mentioned are sublimation, chromatography, and conversion into more crystallizable derivatives, such as amines into their acetyl, benzoyl, or other acyl derivatives, or acids into their chlorides, amides, esters, etc. These are the methods which are generally used in research laboratories. Although they are used also in industrial laboratories, and the technical chemist should be familiar with them, it is beyond the scope of this book to treat them in detail.

Testing the Product for Purity

When a previously unknown compound has been made for the first time, the only criterion of its purity and homogeneity is the constancy of its properties after repeated purification operations. The compound is subjected to the various purification procedures (distillation, recrystallization from as many different solvents as possible, conversion into salts, esters, amides, etc., and regeneration), and is regarded as pure and homogenous if its properties remain unchanged after all these treatments. Even then one cannot be absolutely certain. Again and again, compounds, which have been assumed to be pure, are proven to be mixtures by later research using more refined methods.

In the industrial laboratory, however, the work more often involves compounds which are described in the literature. In such cases it suffices, as a rule, to establish an agreement between the properties of the compound prepared and those described in the literature. The physical constants are the properties which are most easily expressed numerically, and of these, the melting point and the boiling point are the most easily determined.

The determination of the boiling point has already been mentioned briefly in the discussion on distillation, and here we shall deal with the corrections which may be necessary. It is well known that the boiling point is dependent on the pressure and therefore the pressure must be taken into account in an accurate boiling point determination. This correction is not very large, not exceeding about 2°C., at barometric pressures above 700 mm. A larger error under some conditions

may be caused by the fact that only the bulb, and not the whole thermometer, is immersed in the vapor of the boiling substance. A correction must be made for the part of the mercury column, the so-called "exposed stem," which is not heated to the temperature of the vapor. The correction is proportional to the length (l) of the exposed stem (in degrees) and to the difference between the boiling point and room temperature (t). The correction is calculated by the formula:

$$\text{correction} = 0.00015lt$$

It is seen that the correction may be quite large when the boiling point is high. Whenever a boiling point is given, the pressure at which it was taken should be stated, and an indication given as to whether or not a correction for the exposed stem has been applied.

There are instances where a correct boiling point does not demonstrate the purity of a substance. This might apply to cases involving mixtures of substances which boil at the same, or nearly the same temperature, so that the presence of a mixture is not detected from the boiling point. However, if one has prepared a substance, one knows, as a rule, whether such a mixture can be present; and if there is this possibility, the boiling point is not used as a criterion for purity. If, on the other hand, the presence of a by-product having the same boiling point is excluded, then a correct, sharp boiling point may be taken as evidence that no appreciable quantities of impurities are present, and that the material is sufficiently pure for technical use. To be sure, complete purity is not demonstrated, since small amounts of a much higher boiling impurity might go over with the vapor of a lower boiling compound and this would not be apparent from the boiling point. If the specifications call for very high purity, the determination of boiling point is not adequate.

The melting point is much more sensitive to impurities than the boiling point. Just as the freezing point of a liquid is lowered by dissolving a foreign substance in it, so is the melting point of a solid material lowered by the presence of an impurity which is soluble in the melt. A melting point which is too low, therefore, is infallible evidence for the presence of an impurity. Some impurities which are not dissolved in the melt have no effect on the melting point. There are other cases where two isomeric, homologous, or otherwise closely related substances are isomorphous and form mixed crystals, or form a molecular compound which has a characteristic melting point and behaves in every respect like an individual compound. A particularly striking ex-

ample of this phenomenon is afforded by acetyl-*m*-aminophenol and *n*-butyryl-*m*-aminophenol. These two compounds melt at 145° and 138°C., respectively, and an equimolecular mixture of the two melts at 154–155°C. Molecular compounds of this type cannot, as a rule, be separated into their constituents by recrystallization, and their non-homogeneity is usually detected only by conversion to derivatives. Such cases do not occur often, but they are not so rare as is generally assumed; the possibility should always be kept in mind if errors are to be precluded.

Another possibility for difficulty in melting point determinations lies in the presence of solvent of crystallization. It is well known that many compounds crystallize with water of crystallization, or with alcohol or benzene of crystallization, etc. Frequently, the solvent of crystallization is driven off below the melting point and does not affect the latter. In other cases, however, an apparent melting, or solution in the solvent of crystallization, occurs far below the true melting point. A well known example of this behavior from inorganic chemistry is afforded by soda crystals which melt very easily in their water of crystallization. In organic chemistry, it is mainly the high molecular compounds, such as those of the triphenylmethane type, which stubbornly retain solvents of crystallization. A compound of this nature melts at different temperatures depending on the particular solvent of crystallization present, and hence on the solvent from which it was recrystallized. Such a situation can give rise to great confusion if the circumstances are not considered, and therefore melting points should be determined only with samples which have been dried to remove all of the solvent of crystallization.

Finally, difficulties are encountered in determining the melting points of substances which begin to decompose below their melting points. An example of such a compound is phthalic acid which melts at 206–208°C., but which begins to split out water far below this temperature with the formation of its anhydride which melts at 131°. If the melting point apparatus is heated slowly and carefully, and the test sample remains in the warm bath for a long time, the compound is completely converted to the anhydride long before the true melting point of the acid is reached, and the sample gives the appearance of having melted. The melting point obtained is therefore much too low. In such cases, the bath should be preheated to a temperature only slightly below the melting point of phthalic acid before introducing the test sample. Then the heating should be continued as rapidly as possible, so that the acid has little time to undergo anhydride formation, but melts first. Only in this way can one obtain the correct melting point value.

In all the numerous cases where melting with decomposition occurs (usually with high melting compounds), the possibility always exists that what is observed is not the true melting point of the material, but the point at which the compound is decomposed into liquid products. Decomposition points do not depend solely on the temperature, as do true melting points, but also on the length of heating, and the more rapidly the heating is carried out, the higher will be the observed "melting point."

The difficulties which have been mentioned are only partly to blame for the fact that the literature often gives several melting points for a compound, differing from each other by several degrees. A much greater part of the trouble arises from the fact that substances, not entirely pure, were regarded as pure originally. In addition, an appreciable part of the disagreement can be ascribed to the different methods which have been used for determining melting points. First, it must be remembered that the correction for the mercury column not immersed in the heating bath is just as important here as it is in boiling point determinations, but this fact has not always been borne in mind. The necessity for this correction can be eliminated to a certain extent by the use of the shortened thermometers introduced by Zincke. These thermometers cover only a narrow temperature range, for example, 0–50°, 50–100°, 100–150°C., etc., so that the exposed stem is never more than about 50° long. Under these conditions the correction is so small that it can be disregarded. Of course, one must have a complete set of these thermometers, and must know beforehand approximately what the melting point is, in order to be able to select the correct thermometer. The chief use for the Zincke thermometers is in the final checking of a melting point, perhaps before publishing it.

A further source of error in melting point determinations is introduced if the temperature in the melting point tube and in the thermometer bulb is not the same. This difficulty is avoided most easily by using as a heating bath an open beaker with a stirrer so that the entire bath is heated uniformly. The apparatus must be kept open so that the stirrer can be installed without difficulty, and therefore a bath fluid must be used which is neither volatile nor hygroscopic. Practically, one is limited to paraffin oil which is quite satisfactory for moderate temperatures. It rapidly turns dark at higher temperatures, however, so that it must be renewed frequently when melting points around 200°C. are being determined. An enclosed apparatus is more suitable under these conditions because it permits the use of concentrated sulfuric acid as the bath fluid. Sulfuric acid remains colorless even when heated

to its boiling point (about 280°) and, if it should become colored due to contamination by organic materials, it can be decolorized by adding a small particle of saltpeter. The simplest closed apparatus consists of a small round-bottomed flask with a long narrow neck in which the thermometer is held by a cork (Fig. 2). The cork should have a narrow groove cut in it so that pressure is not built up inside the flask. Satisfactory results can be obtained with the apparatus if care is taken to apply the heat slowly and uniformly, by using either a small flame directly under the flask or a larger flame kept in constant motion. It is

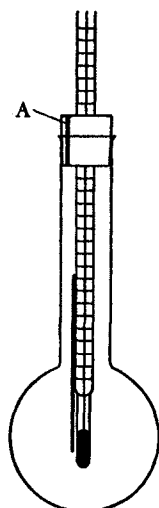

Fig. 2. Melting point apparatus:
A, groove in cork
for pressure equalization.

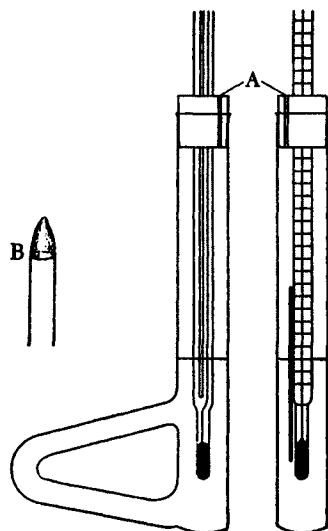

Fig. 3. Thiele melting point apparatus:
A, groove for pressure equalization;
B, flame.

also necessary that the melting point tube be placed so that the sample is at the same height as the middle of the mercury bulb. It has been found that uniform heating of a bath can be obtained by applying the heat, not directly under the thermometer, but to an attached side piece, whereby the bath fluid is made to circulate. The Thiele apparatus is built to make use of this principle (Fig. 3). More accurate tests show, however, that the circulation of the liquid is not entirely uniform, and frequently the side of the tube to which the side piece is attached becomes appreciably hotter than the opposite side. One must be sure, therefore, that the melting point tube is always located in the same place, preferably in the exact center of the tube. If two samples are to

be compared, both of them should be placed at the same distance from the openings into the side piece.

In recent times, apparatus which make use of a metal block, usually copper, instead of a liquid bath medium, have come to be preferred (Fig. 4). The melting point tube is placed in a narrow slit through

Fig. 4. Iseli melting point apparatus, with metal block and three-point illumination. Only the side lights are used until sintering begins, and then the rear light is turned on to permit close observation of the formation of a clear melt. The apparatus is also built with an electrical heating element.

A, block
B, block closure
C, 3 melting point tubes
D, thermometer
E, rear light
F, side lights
G, magnifier
H, microburner
J, mica cylinder
K, air control sleeve
L, stand
M, switch for lights.

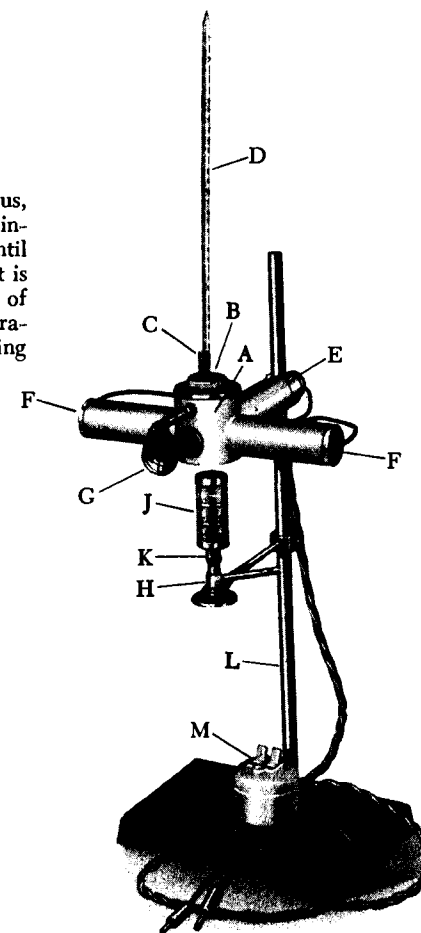

which the melting can be observed, and the thermometer is inserted in a hole directly behind the slit. An apparatus such as this has the great advantage that it can be used for temperatures above the boiling point of sulfuric acid, 280° . Care must be exercised in using it, however; heat must be applied very slowly and uniformly. This may be accomplished by electrical heating, using a constant current, or a very small gas flame

(microburner), always placed in the same position. If the thermometer is then calibrated by melting, under constant conditions, a series of absolutely pure compounds having accurately known melting points, the melting point block is capable of giving reliable results.

Whichever apparatus is used, the safest procedure is always to compare the melting point of the product being tested with that of an authentically pure sample of the same material. The two samples should be melted *simultaneously* in the same apparatus and under exactly the same conditions. Melting point tubes are selected which have as nearly as possible the same diameter and are filled to equal height, taking care that both samples are equally packed. The packing may be done by holding the tubes between two fingers and tapping lightly on the table, or by dropping them onto the table through a fairly long glass tube. The two tubes are attached to the thermometer at the same height, and at the same distance from the heat source.

The same precautions should be observed in establishing the identity of two substances by the so-called mixed melting point. In this case, melting point tubes are filled with the two substances, and a third tube with a mixture of the two substances. The melting points of all three samples are determined *simultaneously in the same apparatus*. If the mixture melts at a lower temperature than the two individual substances, then the two substances are not identical. If the mixture has the same melting point as the individual substances, it is highly probable that the two materials are identical. This conclusion cannot be drawn with absolute certainty, however, because it could be that the two materials are different but are not mutually soluble in the melt, or that they form mixed crystals or a molecular compound accidentally having the same melting point.⁵ One should not be satisfied, therefore, with a mixed melting point determination alone, but should evaluate other properties as well for better control.

The beginner is often uncertain as to which phase of the melting should be taken as the melting point. The following definition might be given. Melting begins when the substance on the wall of the tube begins to flow down; melting is ended when a completely clear melt can be observed. The temperature interval between the beginning and end of the melting is stated as the melting point. As soon as melting begins, the heating should be interrupted and the temperature maintained as nearly constant as possible. The heating is then carefully continued only when it is seen that the melting is not going to be complete. Pure, homogeneous substances, which melt without decomposition,

⁵ Cf. Kofler and Brandstätter, *Ber.*, 75, 496 (1942).

have sharp melting points as a rule; the interval between beginning and end of melting is about 0.5° at the most. This temperature range may be much larger with impure materials or with compounds which melt with decomposition. Frequently, a substance softens and shrinks before melting; this should be designated as sintering, not as melting. An accurate statement of the melting point would read, for example: m.p., $124\text{--}125^\circ$, sinters at 118° .

The infrequently used microdetermination of melting point by the method of Kofler⁶ can only be mentioned here.

Insofar as it is applicable and despite all of its attendant uncertainties the determination of melting point is the most widely used control method because of the ease and rapidity with which it can be carried out. It cannot be used, of course, with substances which are liquid at ordinary temperatures or with solid substances which carbonize or otherwise decompose before melting. Most of the sulfonic acids and their metal salts belong to the latter group. Many liquid substances are distillable without decomposition and with these the boiling point may be used as a criterion of purity. In addition, the determination of density, which is easy to perform, is valuable for purity control if a large enough sample is available. The refractive index and, in the case of optically active materials, the optical rotation, are more difficult to determine, but are very sensitive to the presence of impurities. These latter two properties are of great value for identification and purity control in the terpene field, for example.

Other optical properties to be considered, for both solids and liquids, are color and fluorescence. The great majority of organic compounds are colorless when in a pure state, but crude products are always more or less colored. Most of the colored impurities are removed by the ordinary purification operations (distillation, reprecipitation, recrystallization, perhaps using animal charcoal, etc.), but frequently a slight coloration remains and is not removable without a disproportionately large loss of product. Now a very weak coloration in a substance, which is colorless when pure, is an indication of lack of complete purity. The quantity of colored impurity, however, may be so small that it causes no trouble even for pure research purposes and is completely unimportant in technical work. Naturally, it is difficult to say how strong a coloration is permissible. It might be said that a substance is suitable for technical purposes if its solutions do not appear appreciably colored when viewed in thin layers or single drops. In many in-

⁶ Kofler, "Mikroskopische Methoden zur Identifizierung organischer Substanzen," Supplement to *Z. Ver. deut. Chem.*, No. 36 (1940).

stances, a stronger coloration does no harm; the decision depends on the particular application and must be made for each individual case.

The determination of absorption spectrum is very valuable for the identification of products which are colored in themselves, such as the true dyes. It is of less value as a means of controlling purity because the *position* of the absorption bands is frequently not shifted by the presence of impurities. Test dyeing is used industrially as the chief method for testing dyes for purity, provided that a sample of the pure dye is available for comparison.

Fluorescence is often a valuable indicator of purity, and can often be used for differentiating and recognizing isomeric or closely related compounds, especially those in the naphthalene series. For example, the alkaline solutions of β -naphthol and almost all of its sulfonic acids show strong fluorescence; only those sulfonic acids having the sulfo group in the 1 position show no fluorescence. Hence, in the preparation of 2-naphthol-1-sulfonic acid from β -naphthol, the fact that the product has no fluorescence shows that it contains neither unchanged β -naphthol nor an isomeric sulfonic acid (see page 199). Furthermore, sodium 2-naphthol-6-sulfonate (Schaeffer salt) in aqueous solution exhibits only a very weak violet-blue fluorescence. The salts of both disulfonic acids formed simultaneously (2-naphthol-3,6-disulfonic acid, R salt, and 2-naphthol-6,8-disulfonic acid, G salt) fluoresce much more strongly and with a greenish blue color. The fluorescence of these compounds is increased by the addition of soda, but the character of the fluorescence is unchanged. The presence of a very small amount of R salt or G salt in Schaeffer salt is enough to mask the violet-blue fluorescence completely. Thus, a recognizable violet-blue fluorescence with Schaeffer salt shows immediately that it is practically free from disulfonic acids (cf. page 196).

With all crystalline substances, the crystal form is an intrinsic indication of purity. Impurities are often recognized macroscopically, but more generally their presence is revealed by microscopic observation of a different crystal habit or amorphous character. There are cases where the impurity crystallizes with the main product and is not directly detectable. Such mixed crystals, however, frequently have a different crystal form from that of the pure compound, and are distinguishable if a direct comparison is made with a pure sample. The control of purity of sulfonic acids, which is made difficult by the lack of characteristic melting points, is simplified somewhat by the fact that numerous salts can be prepared from them, and one or more of these will usually be found to have a recognizable characteristic crystal form.

All tests for purity are made easier if a comparison sample of authentic purity is available. If such a sample is not available, it can be prepared by careful purification of a portion of the product itself. One bothersome, but generally applicable, method of testing for purity is carried out by recrystallizing a sample of the product being tested, and comparing the recrystallized material with that retained in the mother liquor. To this end, the mother liquor may be fractionally evaporated, whereupon the impurities, as a rule, will become so concentrated in the last mother liquor that they are easily detected.

Of course, the control of purity must be based not only on the physical properties discussed above, but also on the chemical behavior of the substance being tested. It is extremely difficult to generalize on this point, however. The testing methods must be adapted to the chemical properties of the particular compound being tested and of the impurities suspected to be present; all this requires a general knowledge of the reactions of organic chemistry, which cannot be supplied here. Mention might be made of only one reaction, namely, the formation of azo dyes. This reaction is not frequently encountered in scientific literature but is often used in industrial laboratories with good results. The reaction can be applied to all compounds which are capable of being diazotized or capable of coupling with diazonium compounds. In many cases, impurities likely to be present, such as isomers, give dyes which are sufficiently different from the dyes yielded by the main product to be distinguishable. The components suitable for each individual case must be established by test experiments, and this requires some practice. Schaeffer salt may again be used as an example. We have already seen how an admixture of R salt in Schaeffer salt is recognized. How can the reverse situation be detected, i.e., the presence of Schaeffer salt in R salt? Completely pure R salt reacts in carbonate solution with the diazonium compound from monoacetyl-*p*-phenylenediamine to give a bluish red dye which is practically insoluble in the reaction mixture which contains some salt. When the dye is filtered off, a pale rose colored filtrate is obtained. Schaeffer salt, treated in the same way, yields a more soluble, yellowish red dye which is not fully precipitated under the conditions of the experiment. If the R salt being tested contains even a little Schaeffer salt, then one obtains, after filtering off the dye, a yellowish colored filtrate much stronger in color than when pure R salt is used. The amount of Schaeffer salt present in the original sample can be estimated by the depth of color in the filtrate.

The beginner in the industrial laboratory frequently wants to know when a product which is not completely pure may be designated as

sufficiently pure for technical purposes. A product is sufficiently pure if it is usable for the particular purpose at hand, and hence, if the impurities present do not interfere in the proposed use of the compound. Thus, a great deal depends on the intended application of the compound. The same product might be sufficiently pure for one use, and entirely unsuitable for another. Furthermore, a product considered quite satisfactory for a certain purpose might be unusable if the procedure is changed. The technical applicability varies from case to case, and can be determined only by suitable experiments.

As a starting point for the beginner, it might be said that substances which melt 2 to 3° too low are, in general, suitable for industrial use. It has already been mentioned that moderate color in the product does no damage. Finally, it may be pointed out that inorganic salts, always present in products isolated by salting out, have no damaging effect in most applications, and are generally not even regarded as impurities. Such salts need be considered only with respect to their effect on the quantity of starting material to be used.

Orientation Rules

The dye chemist is frequently faced with the problem of preparing a new intermediate having a prescribed constitution and location of substituents. The solution of this problem is made much easier by an accurate knowledge of all of the laws governing the positions taken by substituents when they are introduced into the various aromatic ring systems. Hence, "orientation rules" will be discussed rather extensively.

1. Orientation in the Benzene Series

Monosubstitution products of benzene exist in only one form, but when a second substituent is introduced into the molecule, any one of three isomers may be formed: ortho, meta and para. Which of the three isomers will be formed in any particular case depends, to a small degree, on the nature of the entering group and on the specific reaction conditions, but it depends chiefly on the nature of the substituent already present. According to this "directing" or "orienting" influence, substituents may be divided into two classes. Groups⁷ in Class 1 include alkyl, aryl (diphenyl bond), halogen, $-\text{OH}$, $-\text{OR}$, $-\text{O-acyl}$, $-\text{NH}_2$, $-\text{NHR}$, $-\text{NR}_2$, $-\text{NH-acyl}$, $-\text{NR-acyl}$, $-\text{N=N-}$, and others. These groups direct an incoming substituent exclusively, or nearly so,

⁷ R = alkyl or aryl.

to the ortho and para positions. Class 2 includes the groups: $-\text{NO}_2$, $-\text{SO}_3\text{H}$, $-\text{SO}_2\text{Cl}$, $-\text{SO}_2\text{R}$, $-\text{CO}_2\text{H}$, $-\text{CO}_2\text{R}$, $-\text{CONHR}$, $-\text{COR}$, $-\text{CHO}$, $-\text{CN}$, etc. These groups orient predominately, but seldom exclusively, to the meta position.

Whether the ortho or para position is favored by the Class 1 substituents depends partly on the particular substituent present, but also to a large degree on the nature of the entering group and often on the reaction conditions, especially the temperature. The sulfo group usually enters the para position preferentially, even exclusively in the sulfonation of chlorobenzene or toluene or in the sulfonation of phenol at elevated temperatures. On the other hand, sulfonation of phenol in the cold gives an appreciable amount of phenol-*o*-sulfonic acid. In halogenation and nitration reactions, both the ortho and para isomers are usually formed; nitration of toluene gives, in addition, a small percentage of *m*-nitrotoluene.

The directing influence of primary, secondary and tertiary amino groups is greatly weakened by the presence of large amounts of concentrated sulfuric acid. Hence, considerable quantities of the meta isomers are formed in the nitration of amines in concentrated sulfuric acid solution, and in the sulfonation of amines by concentrated sulfuric acid or oleum.

The orienting power of the meta directing substituents is much smaller throughout than that of the Class 1 substituents. This is the reason that, as a rule, ortho and para isomers are formed as by-products along with the meta compound.

If there are already two substituents in the benzene ring, they may either direct a third entering group to the same position, or work in opposition to each other. The former is the case if the two groups already present belong to the same class and are located meta to each other, or if one group belongs to Class 1 and the other to Class 2 and they are located ortho or para to each other, for example:

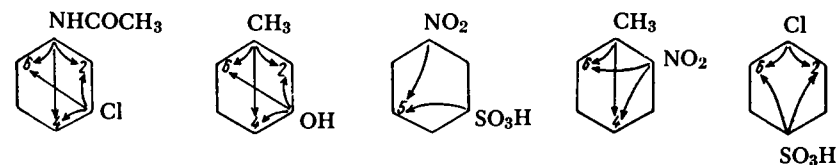

In these cases, the new substituent is directed to the position favored by the joint action of the two groups already present, as indicated by the arrows in the formulas.

If, however, the two groups already present belong to the same class and are ortho or para to each other, or if they belong to different classes and are meta to each other, as in the following examples:

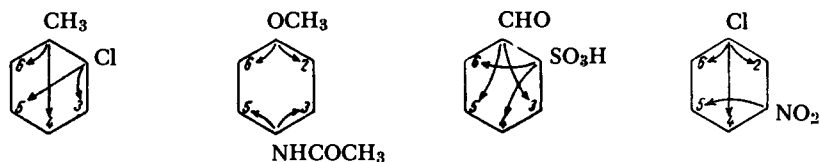

then they will exert opposing influences. Usually this results in the formation of all possible isomers. If one of the substituents is a hydroxyl group, however, its influence outweighs that of the other substituents and is the determining factor. Thus, with *p*-cresol, *p*-chlorophenol, and *p*-acetaminophenol, any new substituent enters exclusively the position ortho to the hydroxyl. The directing power of the hydroxyl group is distinctly reduced by alkylation or acylation. Such substituted hydroxyl groups have about the same directing influence as free or acylated amino groups. Halogen and alkyl groups are very similar in their directing activity; if they are located in a molecule so that they have opposing directing effects, a mixture of the possible isomers in nearly equal amounts is always obtained (e.g., in the nitration of *p*-chlorotoluene).

As mentioned before, the very strong directing effect of the amino group is significantly reduced by the presence of large quantities of concentrated sulfuric acid. This is true especially for free amines, but also to a smaller extent for their acyl derivatives. Thus, acetone-*p*-toluidide is nitrated by aqueous nitric acid exclusively in the position ortho to the acetamido group; in concentrated sulfuric acid solution, however, a considerable quantity of 2-nitro-4-acetaminotoluene is formed along with the 3-nitro compound. *p*-Toluidine itself gives 2-nitro-4-aminotoluene almost exclusively when it is nitrated in the presence of much concentrated sulfuric acid (see page 165). The behavior of *p*-chloroaniline and its acetyl derivatives is similar. In the sulfonation of amines with concentrated sulfuric acid or oleum, the influence of the other substituents may become important or even predominant. On the other hand, in sulfonation by the baking process (see page 126), the sulfo group always enters a position ortho or para to the amino group, regardless of other substituents. Also, the formation of *m*-nitroaniline derivatives can be avoided completely if the arylsulfonyl (especially the *p*-toluenesulfonyl) derivative of the amine

is nitrated with nitric acid in water or an organic solvent.⁸ (*p*-Toluenesulfanilides behave like phenols in many respects; they dissolve in caustic alkalis, couple with diazonium compounds, etc.)

Of the different isomers which might be formed, according to the above rules, by further substitution into disubstituted derivatives, the unsymmetrical (1,2,4) derivatives are strongly favored. Symmetrical (1,3,5) trisubstitution products are formed only with difficulty, and vicinal (1,2,3) derivatives are generally formed only as by-products in insignificant amounts. (The chlorination of *o*-nitrotoluene is an exception, see page 160.)

When substituents of the two classes are working in opposition, the influence of the Class 1 groups usually predominates, or completely masks the influence of the Class 2 groups.

The same principles which govern the introduction of a third group into disubstituted benzene derivatives hold, in general, for the further introduction of a fourth group into trisubstituted derivatives. It is to be observed that here there is a strong tendency for the formation of symmetrical (1,2,4,5) derivatives. These are often the chief products even in cases where predominant formation of other isomers might be expected on the basis of the directing influence of the three groups already present. Thus, nitration of 2-chlorotoluene-4-sulfonic acid gives chiefly 2-chloro-5-nitrotoluene-4-sulfonic acid, even though the methyl and sulfo groups both direct to the 6 position, and only the chloro directs to the 5 position. The same results are obtained in the nitration of 1,2-dichlorobenzene-4-sulfonic acid, 2-chloro-4-nitrotoluene, etc.

2. Orientation in the Naphthalene Series

In the naphthalene series, two isomers, α and β , are possible when only one substituent is present. Nitration and halogenation of naphthalene give practically only the α compound. On the other hand, sulfonation with concentrated sulfuric acid always gives a mixture of the two isomers (pure α -naphthalenesulfonic acid can be obtained by sulfonation with chlorosulfonic acid in an organic solvent), the relative amounts of the two depending on the sulfonation temperature. In the cold, the chief product is the α -sulfonic acid, while at temperatures above 120–130°C., the β -sulfonic acid predominates. It might be emphasized here that the naphthalenesulfonic acids, once formed, frequently undergo rearrangement when heated with concentrated sul-

⁸ Akt.-Ges. Anilin-Fab. Berlin, Ger. Pat. 157,859 (1904), 164,130 (1905), and 163,516 (1905) [*Frdl.*, 8, 104–110 (1905–1907)].

furic acid or oleum, forming finally an equilibrium mixture of the various isomers, the composition of the mixture being dependent on the temperature.

The introduction of a second substituent, and of subsequent ones, is governed by the rules holding in the benzene series, but in greatly modified form. The modified rules may be summarized as follows.

Strongly orienting groups of Class 1 (hydroxyl, alkoxy, and amino or acylamino groups in the absence of concentrated sulfuric acid), when present in the 1 position of the naphthalene nucleus, direct the entering substituent to the *ortho* or *para* position (2 and 4 positions) just as in the benzene series. Less active groups of Class 1 (halogen, and amino in the presence of concentrated sulfuric acid) often give rise to the 5 isomer, instead of the 2 isomer, along with the 4 substituted compound.

Groups of Class 1, when present in the 2 position, direct partly to the 1 position (in direct relation to the strength of their orienting influence), and partly to positions in the other ring, especially the 8 position, then the 6 position. Sulfonation of β -naphthylamine gives a mixture of all four heteronuclear monosulfonic acids. The 3 position is seldom entered, and then only if the other ring bears at least one substituent. The reaction of carbon dioxide with sodium β -naphtholate is an exception to this rule. In this case 2-hydroxy-1-naphthoic acid is formed at lower temperatures, but at higher temperatures the product is 2-hydroxy-3-naphthoic acid.

Groups of Class 2 favor the entrance of a second substituent into the other ring almost exclusively; the meta position of the same ring is usually entered only if there are other substituents already present in the other ring.

Another rule holding generally for the introduction of the second and subsequent substituents is that halogen and nitro groups usually enter the α position, while sulfo groups enter predominantly the α position at lower temperatures and the β position at higher temperatures.

Of greater importance is the rule stated by Armstrong and Wynne, governing the course of sulfonation reactions. This rule says that in direct sulfonation reactions, sulfo groups never enter positions *ortho*, *para*, or *peri* to each other. However, rare and technically unimportant exceptions to this rule are possible under the influence of other strongly directing substituents, but never where substitution by sulfo groups alone is concerned. Thus, the almost unlimited number of possible isomers is greatly reduced, and sulfonation proceeds according to the following scheme:

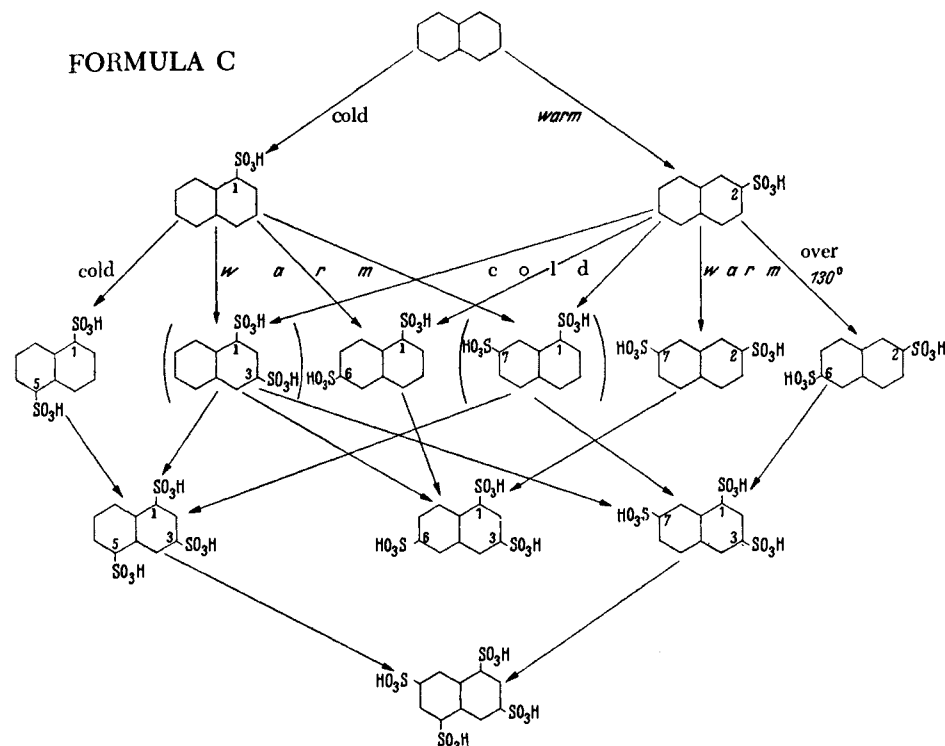

The 1,3- and 1,7-disulfonic acids (in parentheses) are formed in very small amounts.

Further nitration of α -nitronaphthalene leads almost exclusively to 1,5- and 1,8-dinitronaphthalenes.

In the nitration of naphthalenesulfonic acids, the α position of the non-sulfonated ring is attacked preferentially. If a sulfo group is present in each ring, the entering nitro group seeks out whichever α position is not *ortho* or *para* to a sulfo group. If no such position is available, mixtures are formed; in part, the nitro group enters a position *para* to a sulfo group, and in part it takes a β position *meta* to a sulfo group. Naphthalene-1,3,5,7-tetrasulfonic acid cannot be nitrated.

Concerning the sulfonation of naphthols and naphthylamines, see the discussion under the individual compounds.

3. Orientation in the Anthraquinone Series

The relationships in the anthraquinone field are somewhat more complicated than those in the benzene and naphthalene series.

In contrast to benzene and naphthalene compounds, anthraquinone can scarcely be sulfonated with concentrated sulfuric acid because the temperature required is so high that the anthraquinone is largely destroyed. Therefore, fuming sulfuric acid must be used, permitting a lower reaction temperature. Under these conditions, it turns out that it is not possible to introduce a single sulfo group, but a second sulfo group is also introduced. In order to obtain a reasonably pure mono-sulfonic acid, it is necessary to conduct the sulfonation so that only about 50 per cent of the anthraquinone is attacked. Even under such mild conditions, appreciable quantities of disulfonic acids are formed.

When anthraquinone and ordinary fuming sulfuric acid are used, the sulfo groups enter the β positions almost exclusively, as shown in the following structural formulas:⁹

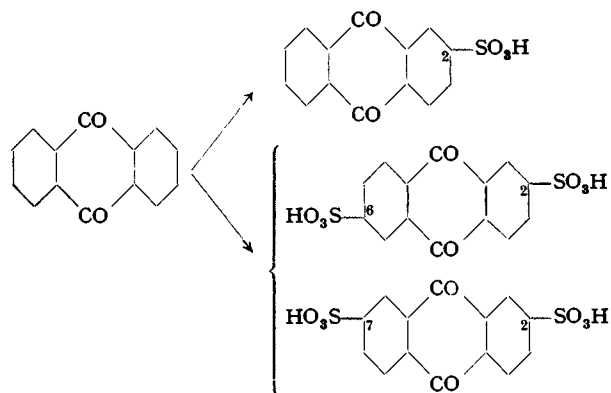

If sulfonation is carried out in the presence of mercury salts, the first sulfo group enters the α position preferentially. If the sulfonation is then carried to the disulfonic acid, the relationships become very complicated, and at least four isomers are formed: the 1,5, 1,8, 1,6, and 1,7 isomers. These isomers can be separated very satisfactorily by keeping the reaction mixture cold (under some conditions with the

⁹ See, for example, Fierz-David, *Helv. Chim. Acta*, 10, 219 (1927).

addition of a little water), whereupon the 1,5-disulfonic acid separates out almost quantitatively. On further dilution, the 1,8 compound precipitates, leaving the 1,6 and 1,7 isomers in the sulfuric acid solution.¹⁰

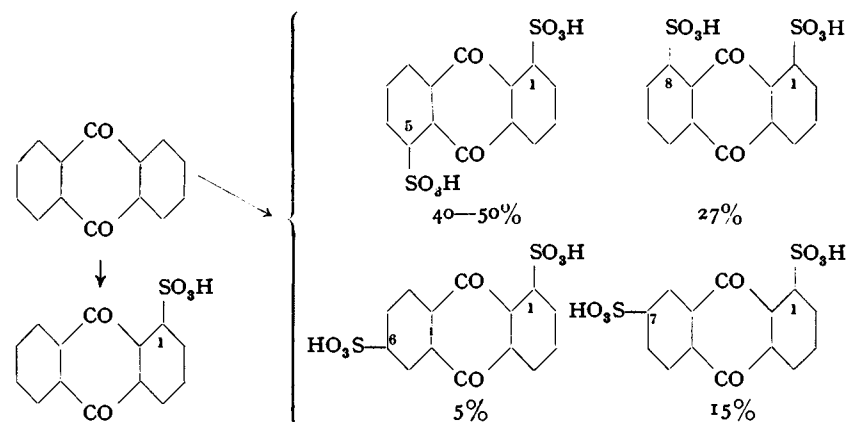

In the anthraquinone series, the α -sulfonic acids are characterized by the fact that the sulfo group is easily split out and replaced by nascent chlorine (also bromine). α -Chloroanthraquinone may be obtained in this way in excellent purity and yield. The β -sulfonic acids also are capable of undergoing this reaction, but the reaction goes very slowly and not quantitatively because, besides replacement of the sulfo group by halogen, some replacement by hydrogen takes place also.

Nitration of anthraquinone proceeds in a manner analogous to sul-

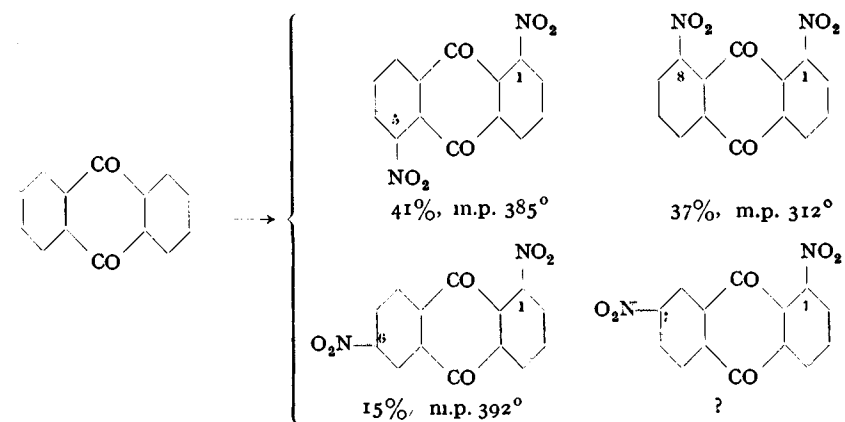

¹⁰ See, for example, Fierz-David, *Helv. Chim. Acta*, 10, 200 (1927).

fonation, except that mercury salts have no effect on the orientation. A technically satisfactory preparation of mononitroanthraquinone has not yet been found.¹¹ The formulas just preceding give the pertinent facts about the dinitroanthraquinones.¹² Here again, the 1,5 derivative is the most difficultly soluble and can be easily obtained pure.

Nitration of anthraquinonesulfonic acids follows the same general pattern as in the naphthalene series. A mixture of various isomers is always formed, and of these the 1,5 derivative is easily separated, the others with more difficulty.

Amination of anthraquinone can be accomplished in various ways. Either the sulfo group is replaced by the —NH_2 or the corresponding nitro compound is reduced. The reduction of nitro compounds in this series takes place very smoothly by heating with sodium sulfide solution. The formation of a green hydroxylamine derivative, soluble in sodium sulfide solution, is always observed as an intermediate step, after which the pure amine separates as a red crystalline precipitate which needs only to be washed. In the replacement of the sulfo group by —NH_2 , effected with ammonia at high temperature (hence, under pressure, see pages 229 and 231), it is necessary to remove the ammonium sulfite formed in the reaction in order to prevent extensive reductive destruction of the anthraquinone derivative. For this purpose, reagents are used which either oxidize the sulfite, such as pyrolusite, arsenic acid, *m*-nitrobenzenesulfonic acid, and many others, or precipitate it as the alkaline earth or magnesium salt so that it is harmless (see page 230). These aminations do not proceed quantitatively, and today, for example, β -aminoanthraquinone is usually prepared from 2-chloroanthraquinone, which in turn is easily prepared from phthalic anhydride and chlorobenzene.¹³

The introduction of an hydroxyl group into the anthraquinone molecule is accomplished by heating the corresponding sulfonic acid with an alkaline earth hydroxide, whereby again the harmful sulfite is precipitated. If caustic alkali is used, undesired side reactions occur which lead, under certain conditions, especially in the presence of oxidizing agents, to more highly oxidized anthraquinone derivatives (see alizarin, page 314). Quinizarin, i.e., 1,4-dihydroxyanthraquinone, is prepared most satisfactorily today by condensing phthalic anhydride with *p*-chlorophenol in the presence of concentrated sulfuric acid,

¹¹ Concerning the mononitration of 2-methylanthraquinone, see p. 227, as well as Locher and Fierz, *Helv. Chim. Acta*, 10, 642 (1927).

¹² Hefti, *Helv. Chim. Acta*, 14, 1404 (1931).

¹³ M., L., and B., Ger. Pat. 75,288 (1894) [*Frdl.*, 3, 260 (1890–1894)].

usually also in the presence of boric acid which transforms the quinizarin into the boric acid ester, thus preventing its further reaction.¹⁴

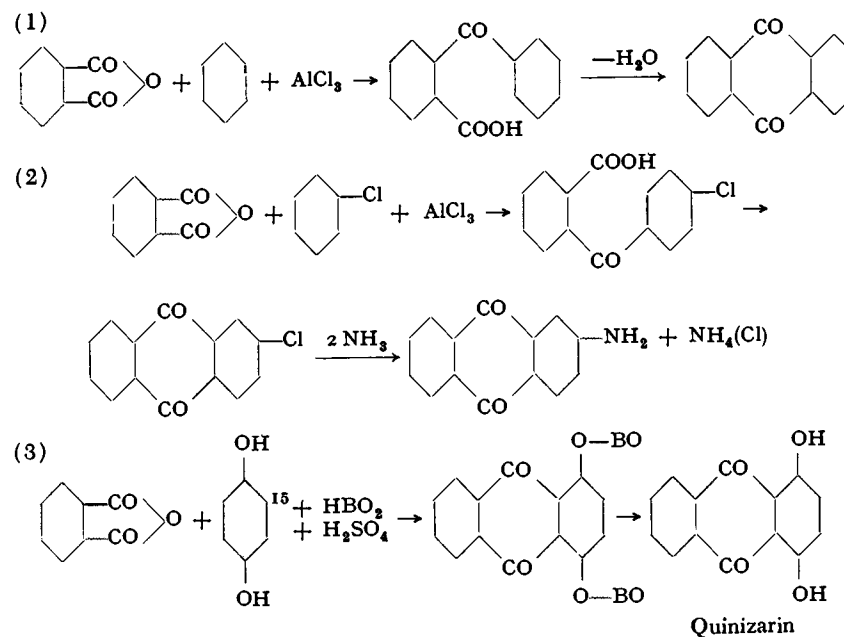

Further transformations of the anthraquinone derivatives mentioned above lead to very complicated relationships under some conditions, and these can be discussed only briefly here.

1-Aminoanthraquinone can be sulfonated relatively easily in the 2 position by treating it with fuming sulfuric acid in the presence of bisulfate. The 1-aminoanthraquinone-2-sulfonic acid thus formed can also be prepared smoothly by baking the acid sulfate of 1-aminoanthraquinone at 200°C.¹⁶ It is a very important starting material for the preparation of valuable acid anthraquinone dyes.^{16a}

Instead of the amino group, other amine residues can be introduced. Of special importance are the dianthraquinonylamines, which can be converted by condensation into brown carbazole-anthraquinone vat dyes. This condensation is usually brought about by aluminum

¹⁴ See p. 237 and Bayer & Co., Ger. Pat. 255,031 (1912) [*Frdl.*, 11, 588 (1912–1914); *C.A.*, 7, 1587 (1913)]. Also Murch, U.S. Pat. 1,746,736 (1930) [*C.A.*, 24, 1651 (1930)]. General literature: Houben, *Das Anthracen und die Anthraquinone*, Thieme, Leipzig, 1929.

¹⁵ Or *p*-chlorophenol (Ger. Pat. 255,031, see footnote 14).

¹⁶ Cf. Huber, *Dissertation*, Zürich, 1931, p.49.

^{16a} Fierz-David, *Künstliche organische Farbstoffe*, Ergänzungsband. Springer, Berlin, 1935, p. 77.

chloride, less often by aluminum sodium chloride or aluminum chloride and pyridine. These reactions are described in an interesting book by Kränzlein,¹⁷ along with a large number of other syntheses which are very important technically, such as the preparation of dibenzopyrene-quinone (indanthrene golden yellow GK) from benzanthrone and benzoyl chloride in the presence of aluminum chloride and oxygen.

Halogenation of anthraquinone takes place only with difficulty, but the hydroxyl and amino derivatives are easily halogenated, particularly with bromine. Thus, 1-aminoanthraquinone is brominated smoothly in glacial acetic acid to yield 1-amino-2,4-dibromoanthraquinone, an important starting material for the preparation of beautiful acid wool dyes (page 232).

For the sake of completeness, the so-called Bohn-Schmidt reaction should also be mentioned. This reaction is an oxidation of anthraquinone with fuming sulfuric acid or, under some circumstances, the oxidation of the nitro derivative in the presence of sulfur and boric acid. At the present time, these reactions are of little importance technically.¹⁸

Because of the high reactivity of anthraquinone toward various reagents, reactions are possible in this series which are unknown in the benzene and naphthalene series. Two examples might be mentioned: the indanthrene fusion, whereby two anthraquinone molecules are joined through two —NH— groups, and the dibenzanthrone fusion, in which two dibenzanthrone molecules are joined to form important vat dyes. This heightened reactivity often appears to an even greater degree in the derivatives of anthraquinone, as, for example, in the preparation of quinizarin green base (page 317).

4. Orientation in the Carbazole Series

Carbazole behaves on substitution like a derivative of diphenylamine, i.e., it is attacked first in the positions which are ortho or para to the imino group. Introduction of a substituent in the position meta to the nitrogen can only be accomplished indirectly. Thus, strongly

¹⁷ G. Kränzlein, *Aluminiumchlorid in der organischen Chemie*. 2nd ed., Verlag Chemie, Berlin, 1935.

¹⁸ See Fierz-David, *Künstliche organische Farbstoffe*, Hauptwerk. Springer, Berlin, 1926, p. 538 ff.

directing Class 1 groups may be introduced into both para positions so that the group entering subsequently is directed to a position meta to the nitrogen.

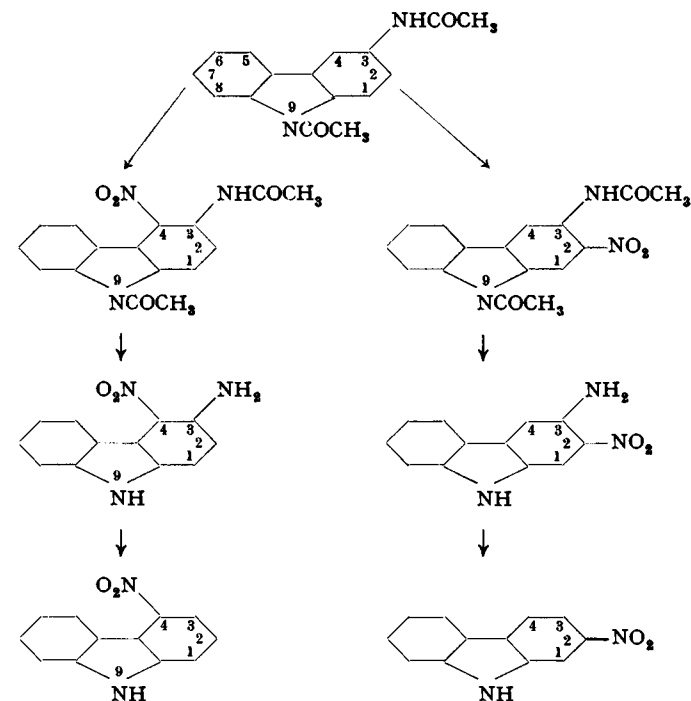

Another possibility is to start out with biphenyl, introduce the desired substituents, and then introduce amino groups into the 2 and 2' positions and close the carbazole ring.

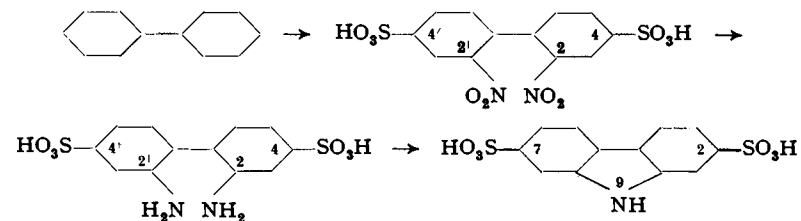

A. COMPOUNDS OF THE BENZENE SERIES

I. Chlorobenzene

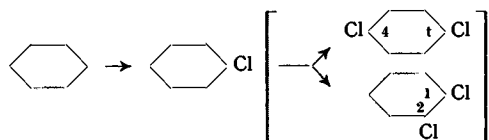

Benzene undergoes a substitution reaction with chlorine only in the presence of halogen carriers. An addition reaction takes place in the absence of a carrier, leading to the formation of benzene hexachloride. Iron is the only halogen carrier used extensively in industry, a suitable form being fine iron powder.

Chlorination is best carried out at about 30°C. At lower temperatures, the reaction proceeds poorly, while at higher temperatures the formation of by-products is favored (di- and polychlorobenzenes, or even benzene hexachloride, especially if the reaction is carried out in sunlight). Chlorine is taken from a cylinder provided with a reduction valve which permits accurate regulation of the gas flow. In all chlorinations of this type, it is important to exclude moisture, since even traces of water retard the absorption of chlorine and favor the formation of by-products. Hence, the reaction flask should be preceded by at least two ordinary gas washing bottles containing concentrated sulfuric acid. More effective still is a so-called "spiral gas washing bottle" in which the gas is made to flow along a long spiral path through the sulfuric acid. The gas washing bottles should be followed by a drying tower filled with pumice, or a "reversed" gas washing bottle filled with glass wool, to catch entrained droplets of sulfuric acid (see Fig. 5).

A relatively tall and narrow glass cylinder may be used advantageously as a chlorination vessel, so that the chlorine is made to pass through a thick layer of the liquid. The vessel is equipped with an efficient reflux condenser, preferably connected by a ground glass joint or, if this is not available, by a cork treated with cellulose acetate varnish. The reaction vessel is placed in a water bath through which cold water can be circulated. The hydrogen chloride escaping from the condenser is conducted to a round-bottomed flask containing caustic soda or water. This flask must not be connected to the reflux condenser with an

air-tight seal, or the air cannot escape from the apparatus. The tube from the condenser should discharge directly above the surface of the absorption liquid, but should not dip into it or the liquid will be drawn back into the apparatus.

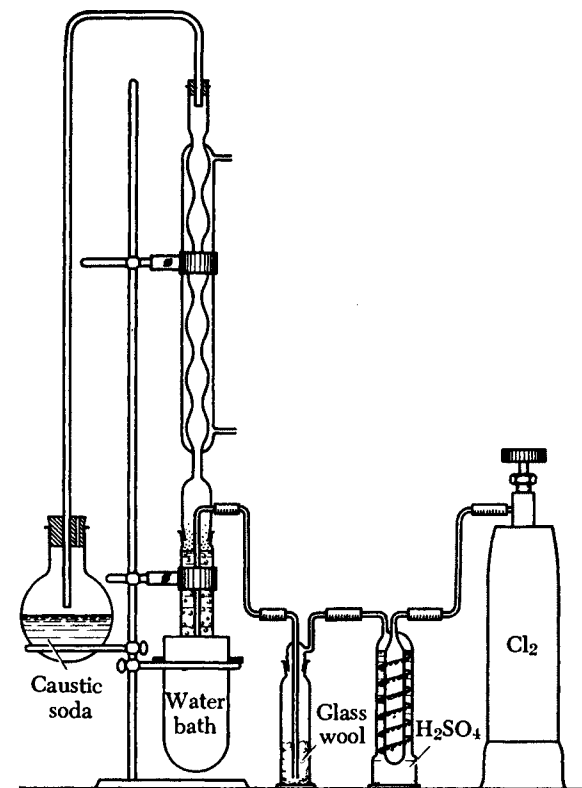

Fig. 5. Laboratory chlorination apparatus.

The separate parts of the apparatus are connected glass-to-glass, so far as possible, by means of short pieces of thick-walled rubber tubing (pressure tubing). Where longer connections are unavoidable, they should be made with either glass or lead tubing; the latter, before use, should be cleaned carefully and dried by a blast of air.

A vigorous stream of chlorine is passed through a 500-cc. chlorination flask in which are placed 312 g. (4 moles) dry benzene (the quantity of benzene that can be chlorinated conveniently in the laboratory in the course of a day) and 5 g. iron powder.

After a considerable quantity of chlorine has dissolved in the ben-

zene, the start of the reaction is evidenced by a sudden rise in temperature. The stream of chlorine is diminished and the flow of cooling water is started, after which the introduction of chlorine is again accelerated to such a rate that the reaction temperature is maintained at about 30°C. A much more rapid stream of chlorine leads to incomplete absorption of the gas. Efficient cooling in the reflux condenser is necessary in order to retain as much as possible of the benzene entrained in the hydrogen chloride.

The hydrogen chloride formed in the reaction is led into a 2-liter flask which contains a mixture of 300 cc. sodium hydroxide solution (30° Bé) and 700 cc. water, or water alone.

The progress of the reaction is determined from time to time by weighing. For this purpose, the loss in weight of the chlorine cylinder, the gain in weight of the reaction flask, or the gain in weight of the absorption flask, can be determined. In industrial work, the chlorine cylinder is usually weighed, but this may not be possible in the laboratory due to the lack of a suitable balance weighing accurately to 1 gram and having the necessary capacity. Weighing of the absorption flask is usually most suitable, but this procedure can be used only if the chlorine is completely absorbed, as it should be in this experiment. It is recommended that the weight increase of the chlorination flask also be determined as a check at the end of the reaction. It is to be noted that the absorption of one gram atom of chlorine should correspond to a weight increase of the reaction flask of 34.5 grams (Cl minus H), an increase in weight of the absorption flask of 36.5 grams (HCl), and a decrease in weight of the chlorine cylinder of 71 grams (Cl₂).

The reaction is interrupted when 80 per cent of the chlorine calculated as necessary for the formation of monochlorobenzene has been taken up, that is, when the weight of the reaction flask has been increased by 117 grams. If the chlorination is continued beyond this point, the amounts of higher chlorination products increase rapidly and the yield of monochlorobenzene is not increased appreciably. The iron is now allowed to settle and the liquid is decanted into a separatory funnel, washed thoroughly with dilute hydrochloric acid, then with soda solution, and finally with water. The reaction product, weighing about 410 to 420 grams, is subjected to fractional distillation, preferably in vacuum. In order to effect a separation of the mixture in one distillation operation, a column should be used which is at least 60 cm. high, filled with glass rings, and provided with a partial condenser (see page 342). Typically, the following fractions are obtained at *atmospheric pressure*:

- (1) 70–100°, benzene with a little chlorobenzene, about 70 grams
- (2) 120–130°, almost pure chlorobenzene, about 295 grams

and at 9 mm. pressure:

- (3) up to 55°, mono- and dichlorobenzene, about 10 grams
- (4) 55.5°, *o*- and *p*-dichlorobenzene, about 40 grams
- (5) higher boiling products and residue, very small amount.

By cooling fraction 4 to about 10° and centrifuging, about 12 grams of pure *p*-dichlorobenzene can be obtained.

The yield of monochlorobenzene is 295 grams, or 65 per cent based on the benzene started with, 84 per cent based on the benzene actually used up in the process.

Technical Observations. Chlorobenzene is an important intermediate in the preparation of a whole series of other compounds (see Section 6 and Tables 1 to 5). It is produced in batches of 2000 kilograms or more in cast iron kettles equipped with agitators and reflux condensers.

Only about 60 per cent of the theoretical amount of chlorine is introduced, whereby the formation of higher chlorination products is greatly reduced and the yield of chlorobenzene, based on the unrecovered benzene, is appreciably increased. The unused benzene is always put back through the process. The rectification is carried out under rigorous control. (Concerning fractional distillation, see also page 341 ff.)

The hydrochloric acid formed in the chlorination is collected in water, and the small amount of chlorine carried over is neutralized by the addition of a small amount of sodium bisulfite. The resulting "chlorination hydrochloric acid" plays an important role in the dye plant. It is cheap and very pure.

The dichlorobenzene which is always formed in small quantity along with the monochlorobenzene is a mixture of the *ortho* and *para* compounds. The latter isomer is easily obtained pure since it is a solid at ordinary temperatures; it is used in the preparation of a series of intermediates (see Section 6 and Table I), and finds use also as a moth repellent. The liquid *o*-dichlorobenzene, on the other hand, can be freed from the last traces of the *para* isomer only with great difficulty. It is difficult to manufacture, therefore, and it is generally used only as a high boiling, inert solvent.

An interesting method for chlorination of benzene consists in mixing benzene with chlorine and passing the solution through a contact column filled with iron turnings (Poma-Cesano-Maderno).

The formation of di- and polychlorobenzenes is greatly reduced by mixing the chlorine with a large excess of benzene flowing continuously through a tube, then passing the mixture over the catalyst and into the boiler. The unreacted benzene is continuously distilled off through a good fractionating column and returned through the chlorination chamber, while the chlorobenzene remains in the boiler. Up to 95 per cent of the benzene can be converted to monochlorobenzene in this way.

Halogenation in General

Chlorination is almost always carried out technically by the direct action of gaseous chlorine. Substances which are liquid at the reaction temperature are usually treated, without dilution, with chlorine gas, as described above for

benzene. Solid substances, on the other hand, must usually be dissolved or suspended in a suitable liquid. For this purpose, of course, only those solvents are suitable which are attacked with difficulty, or not at all, by chlorine under the conditions employed. Suitable inorganic liquids are water and concentrated sulfuric acid, and the organic liquids most commonly employed are carbon tetrachloride, tetrachloroethane, nitrobenzene, *o*-dichlorobenzene, trichlorobenzene, and glacial acetic acid. Efficient stirring should be provided in all cases in order to ensure good utilization and uniform action of the chlorine. It is advantageous to introduce the chlorine in a finely divided state, for example, by passing it through a cylinder of porous material (porous stone). It is also recommended, particularly if the chlorine is taken up slowly, that a high and relatively narrow vessel be used so that the gas is made to pass through as thick a liquid layer as possible.

Many chlorinations take place smoothly only if no trace of water is present. In these cases, the substance to be chlorinated, the solvent, and the chlorine should all be dried as carefully as possible. Even in those cases where the chlorine might be used without drying, it should be passed through a wash bottle containing sulfuric acid so that the velocity of the gas stream can be observed. The progress of the chlorination is followed by weighing the chlorine cylinder, the reaction flask, or the flask for absorbing the hydrogen chloride, the latter only if no unused chlorine is collected. In this connection, it should be noted that only one-half of the chlorine is used in the substitution reaction, the other half escaping in the form of hydrogen chloride. It should also be remembered that not only hydrogen chloride, but also chlorine, may be appreciably soluble in the reaction mixture, and for this reason a rapid absorption of chlorine may be deceiving. In addition, the stream of escaping hydrogen chloride gas can easily entrain volatile substances or solvents. Their loss is prevented by using an efficient reflux condenser.

Because of the high toxicity of chlorine, the whole chlorination apparatus should be placed under an efficient hood and tested carefully for leaks. Long lengths of rubber tubing should not be used, because rubber is rapidly destroyed by chlorine. All joints through rubber tubing should be wired.

The optimum conditions for chlorinations vary within wide limits, depending on the nature of the starting material. Aromatic hydrocarbons, as well as their halogen and nitro derivatives, usually undergo nuclear chlorine substitution only in the presence of a halogen carrier. In the absence of a carrier, the chlorine adds, or a side chain may be chlorinated if one is present. In industrial operations, the most commonly used carrier is iron, either as the metal or in the form of ferric chloride. Sometimes iron is used in combination with iodine, and less often, iodine itself, antimony, or antimony chloride is used. In order to bring about the substitution of chlorine in the side chain of a homologous aromatic hydrocarbon, it is necessary to exclude, very carefully, the aforesaid carriers and to work at higher temperatures, usually under illumination; it is also often advantageous to add phosphorous or its chloride.

Amines are seldom chlorinated in the free form because of the strong oxidizing action of chlorine. An exception is *p*-nitroaniline which reacts smoothly with chlorine in the presence of concentrated hydrochloric acid to yield, first, 2-chloro-4-nitroaniline, and then, 2,6-dichloro-4-nitroaniline:

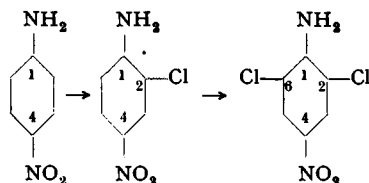

Usually, it is necessary to protect the amino group by acylation and carry out the chlorination under cooling, in order to avoid side reactions. These amino derivatives react very readily with chlorine even in the absence of a carrier.

Halogenation of phenols takes place still more easily, so that with these it is often difficult to prepare a monohalogen derivative by direct action of free halogen. In order to obtain monochlorinated phenols, it is usually necessary to use a mild chlorinating agent. Sodium hypochlorite is used for this purpose. It reacts smoothly with phenol to yield the monochloro compound, predominantly *o*-chlorophenol, when used in equimolecular quantity in alkaline solution. Sulfuryl chloride (SO_2Cl_2), on the other hand, reacts with phenol to yield chiefly the *p*-chlorophenol (see page 145). Sulfuryl chloride is usable not only for phenols, but finds frequent use as an easily controllable chlorinating agent, especially in the anthraquinone series.

Sometimes it is possible to obtain an energetic and smooth chlorination by the use of nascent chlorine, generated in the reaction mixture itself, from hydrochloric acid and an oxidizing agent. Suitable oxidizing agents are hypochlorite (e.g., in the chlorination of acet-*o*-toluidide), chlorate, or even nitric acid (e.g., in the preparation of chloranil by means of aqua regia, see page 146).

Under some conditions, chlorine can replace not only hydrogen, but also certain substituent groups such as sulfo, carboxyl, nitro, etc. Use is made of these reactions especially in the anthraquinone series (see page 236). They are, however, not unknown in the benzene series. Thus, *p*-toluenesulfonyl chloride, when treated with chlorine at a high temperature in the absence of iron and antimony but in the presence of phosphorus pentachloride, gives *p*-chlorobenzo-trichloride (replacement of the $-\text{SO}_2\text{Cl}$ group by chlorine):¹⁹

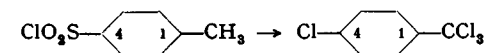

What has been said about chlorination applies generally for bromination, except that bromine is usually added in the liquid form to the reaction mixture. In isolated cases, however, better results are obtained if the bromine is introduced in the gaseous form. With sensitive substances, bromination often takes place more smoothly than chlorination and yields a purer, more easily crystallized product. Under these circumstances, the higher price of bromine is more than offset by the better yields. If concentrated sulfuric acid is used as the solvent in brominations, the hydrogen bromide formed in the reaction is more or less completely oxidized back to bromine by the sulfuric acid. In such cases, less than the calculated amount of bromine is used, sometimes only one-half or a little more.

Iodination and fluorination are encountered only rarely in dye chemistry.

It is not always possible to introduce, by direct halogenation, a chlorine or a bromine atom entirely or predominantly into the desired position. Thus, *m*-dichlorobenzene cannot be obtained by further chlorination of chlorobenzene. Similarly, *o*-chlorotoluene cannot be prepared satisfactorily by direct chlorination of toluene, because it is always formed along with the para compound and the two cannot be separated in any practical way. For these preparations, it is usually necessary to use the Sandmeyer reaction (replacement of an amino group by halogen through the diazonium compound), although it is a rather costly and unreliable technical process and seldom runs smoothly. In other cases, a roundabout method can be used, involving blocking the position where the halogen is not desired by means

¹⁹ Soc. Chim. Usines Rhône, Ger. Pat. 98,433 (1898) [*Frdl.*, 5, 41 (1897-1900)].

of a sulfo group, and then splitting out the sulfo group after the halogenation reaction.²⁰

2. Nitrobenzene

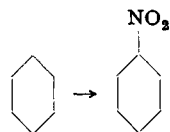

In a three-necked flask fitted with an efficient stirrer, thermometer, and dropping funnel (see Fig. 6) 100 grams of benzene is placed. To

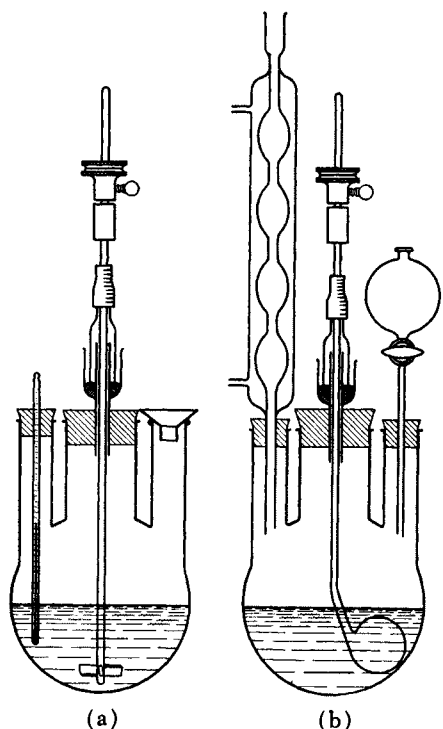

Fig. 6. (a) Three-necked flask fitted with thermometer, filling funnel, and propellor stirrer with gas-tight seal; (b) three-necked flask fitted with reflux condenser, dropping funnel, and paddle stirrer with gas-tight seal.

²⁰ Cf. the preparation of *o*-chlorotoluene from *p*-toluenesulfonic acid according to Badische A. und S. F., Ger. Pat. 294,638 (1916) [*Frdl.*, 12, 908 (1914-1916); *C.A.*, 11, 2582 (1917)]. See also, p. 163.

this is added, over a period of about 30 minutes, with vigorous stirring, a cooled mixture of 110 grams of nitric acid (sp.gr. 1.44, 44° Bé, 75 per cent HNO₃) and 170 grams of concentrated sulfuric acid (66° Bé). The temperature of the reaction mixture is held at 50°C. by external cooling. Instead of a glass flask, a porcelain beaker having a tight cover, or a covered enameled kettle can be used. In any case, it is essential that both the thermometer and the stirrer are immersed in the liquid at all times. In order to ensure a smooth nitration, nitric acid of sp.gr. 1.46 (46° Bé, 80 per cent HNO₃) may be used; in the plant, the 44° Bé acid gives good results. When the addition of the mixed acid is completed, the mixture is stirred for 2 hours at 50°, and then the temperature is raised to 60°. Completion of nitration is established by a nitrometer test showing that the residual nitric acid corresponds to the small excess used. The nitrobenzene is separated from the acid layer in a separatory funnel, washed with water, then with soda solution, and finally with water. The neutral nitrobenzene (litmus test) is distilled directly, giving a first fraction containing water and a small amount of benzene, and then a fraction of pure nitrobenzene. High boiling liquids are usually distilled in the simple apparatus shown in Figure 7; sometimes the Liebig condenser is omitted and the receiver is cooled by a stream of water.

The yield of pure nitrobenzene boiling at 205° is about 150 grams, or 95 per cent of the theoretical amount.

Technical Observations. Nitrobenzene is one of the large volume products of the dye industry. It is used in the preparation of aniline and benzidine, as well as a series of other intermediates, particularly those of the meta series (see Table VI); it is also used in the preparation of the important dye, nigrosine. Nitrobenzene is also used as a solvent, and occasionally as a mild oxidizing agent (fuchsin fusion, quinoline synthesis). In the industrial preparation of nitrobenzene, batches of up to 1500 kilograms of benzene are used and yields of 98 per cent are obtained. A large scale nitration requires about 12 hours, and up to 97 per cent of the nitric acid is utilized. The course of nitration is followed by quantitative determination of the nitric acid in the reaction mixture, using the Lunge nitrometer. At the end of the reaction, the waste acid should contain only about 1 per cent of nitric acid. The nitrobenzene is commonly used without further purification, but if it is to be purified, vacuum distillation is always used.

Figures 8 and 9 show a nitration kettle with inner cooling, such as is used for nitrating aromatic hydrocarbons, and a separating funnel equipped with a hard lead or ceramic stopcock and having a window (lunette). The apparatus used for nitrating benzene must be completely lead lined because the spent acid is highly diluted at the end of the nitration and attacks iron.

Nitration in General

Nitration of aromatic compounds is carried out industrially, in most cases, using a mixture of nitric and sulfuric acids (mixed acid or nitrating acid). The sulfuric acid serves to take up both the water formed in the nitration reaction and

that originally present in the nitric acid; in this way a sufficiently high concentration of nitric acid is maintained throughout the reaction, and almost complete utilization of the nitric acid is made possible. Sulfuric acid is also an excellent solvent for many substances. Due to its high heat capacity, the sulfuric acid serves to absorb the heat of reaction, making for a smooth and uniform reaction. When used in large excess, sulfuric acid even protects a free primary amino group from attack by nitric acid (cf. 2-nitro-4-aminotoluene, page 165).

In dye plants, a whole series of nitrating acids is kept on hand, prepared by mixing, with cooling, nitric acid of various concentrations with concentrated sulfuric acid or with oleum. From these various mixtures, containing different amounts of water and different ratios of nitric to sulfuric acids, one can be selected as suitable for any specific nitration. The more difficult a substance is to nitrate, the less water should be present in the mixed acid. Indeed, in many cases a mixed acid containing free SO_3 is used (see page 150).

Since nitration is a strongly exothermic reaction, good cooling should be provided, as a rule, particularly since many nitrations go smoothly only at lower temperatures; at higher temperatures, oxidation or some other side reaction may be strongly favored. If several isomers are formed simultaneously in a nitration, the temperature may have some, but usually a rather small, influence on the relative amounts of the isomers formed. In order to avoid a dangerous rise in temperature on the addition of the nitric or mixed acid, it is *absolutely necessary to have continuous, vigorous stirring in all nitrations*, especially if the substance being nitrated does not dissolve in the nitric acid, as in the case of benzene. Under the latter condition, two layers are formed if no stirring is used, and when the reaction starts at the liquid-liquid interface, strong local overheating occurs which might lead to an explosion. A terrible explosion once occurred during the preparation of nitrobenzene in the aniline plant at Rummelsburg, when the nitrating acid was added while the stirrer was not running and the stirrer was started later. Since then, such accidents have been prevented by the use of devices which permit the addition of the acid only when the stirrer and the cooling system are functioning. Accidents have happened in the laboratory when the stirrer was installed so that it did not reach the liquid level at the start of the reaction; in a matter of seconds after the liquid level reached the stirrer, an explosive reaction occurred. Extreme precautions are taken in the laboratory, therefore, especially when using nontransparent reaction vessels, to see that the stirrer and the thermometer are immersed in the liquid at the start.

The type of procedure described in the foregoing example — addition of the mixed acid to the substance being nitrated — is used only in a few, but technically very important, nitrations. More often, the substance to be nitrated is dissolved in concentrated sulfuric acid and to this solution is added nitric acid or mixed acid with stirring and cooling. The use of mixed acid here has the advantage that the heat arising from mixing nitric and sulfuric acid is not generated in the reaction mixture, and thus does not add to the heat of nitration. If a nitration follows a sulfonation reaction, it is usually carried out right in the sulfonation mixture (cf. 2-nitrochlorobenzene-4-sulfonic acid, page 104).

In many nitrations, for example, of primary amines, the nitric acid must be completely free from nitrous acid; in such cases, before the nitric acid is used, or before it is mixed with the sulfuric acid, it should be freed from nitric oxide by blowing air through it (cf. nitration of *p*-toluidine, page 165). It is also possible to add saltpeter, instead of nitric acid, to the sulfuric acid solution; this procedure is less satisfactory, however, because saltpeter is not readily soluble in sulfuric acid at low temperatures, and a steady reaction is hard to maintain.

It is often observed that prolonged treatment with the nitrating mixture results in a lowering of the yield and purity of the product; it is advisable, therefore, to remove the product immediately after the nitration is complete. Using the

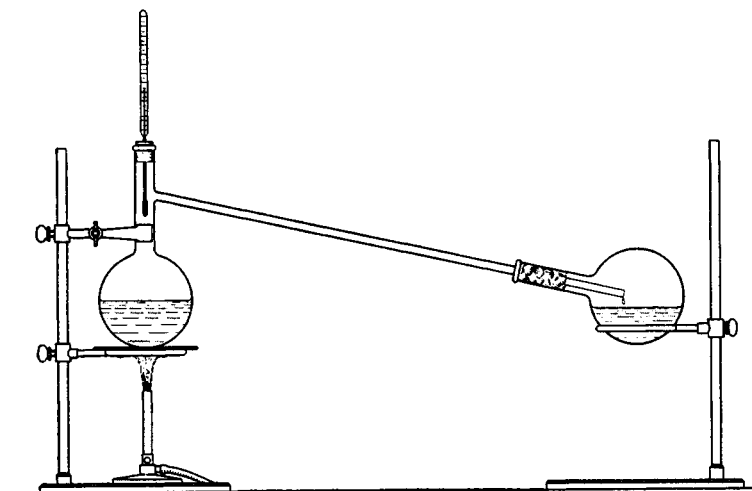

Fig. 7. Distillation apparatus for high-boiling liquids.

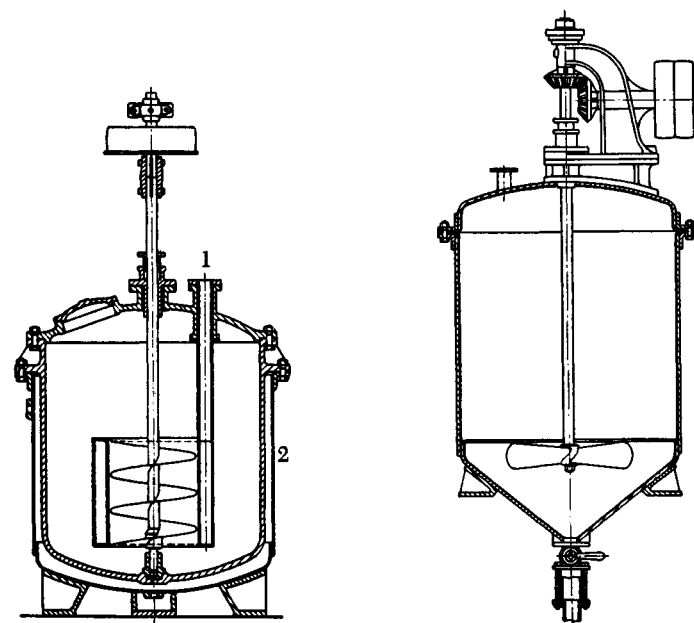

Fig. 8. Nitration kettle with auger-type stirrer, equipped for external and internal cooling: (1) water inlet tube for internal cooling; (2) heating and cooling jacket.

Fig. 9. Separating funnel and extraction apparatus with propellor stirrer and transparent window.

Lunge nitrometer, the consumption of the nitric acid can easily be followed and the end of the reaction determined.

The presence of concentrated sulfuric acid, in many cases, influences the position taken by the nitro group. For example, it weakens the orienting action of acetylated or formylated amino groups, and that of free amino groups to an even greater extent; the other substituents present may then have an influence on, or even determine, the position taken by the nitro group. This effect may be undesirable and make it necessary to avoid the use of mixed acid.

In addition, substances which are easily sulfonated, hydrolyzed, or otherwise changed, by concentrated sulfuric acid cannot be nitrated in sulfuric acid solution. In these circumstances it is necessary either to use aqueous nitric acid of suitable concentration, or to carry out the nitration with concentrated nitric acid in a solution or suspension in an organic liquid. The organic liquid must be one which is affected as little as possible by nitric acid under the conditions prevailing in the process (for example, glacial acetic acid, nitrobenzene, or *o*-dichlorobenzene).

Indirect introduction of a nitro group into an aromatic nucleus is rarely encountered in industrial operations.

The Lunge Nitrometer

The Lunge nitrometer provides a simple and very useful means for controlling nitrations carried out in concentrated sulfuric acid solution. Its usefulness for the determination of the oxyacids of nitrogen, especially nitric and nitrous acids, depends on the fact that these acids (and their salts and esters) are quantitatively and rapidly reduced to NO by metallic mercury in the presence of concentrated sulfuric acid, even at ordinary temperatures, according to the reaction:



The gaseous NO can be measured volumetrically.

Stable nitro compounds, in contrast to the nitric acid esters, are not attacked.

The nitrometer (Fig. 10) consists of a reaction and measuring tube (a) of 50-cc. capacity graduated in 0.1-cc. divisions. At the top of this tube is a three-way stopcock connecting the tube to the filling cup (c) and the exit capillary (d). The reaction tube is connected at the bottom with the leveling tube (b) by means of thick-walled rubber tubing.

For carrying out a determination, 1 to 2 grams (about 1 cc.) of the nitration mixture is weighed out in a small test tube to an accuracy of 0.01 gram. After the measuring tube (a) has been filled up to the stopcock with mercury, the sample is transferred to the filling cup (c) and then run into the measuring tube by lowering the leveling tube (b) and carefully opening the stopcock. Care must be taken that no air is admitted to the measuring tube. The weighing tube is rinsed three or four times with 1–2 cc. portions of concentrated sulfuric acid, which

are transferred successively into the measuring tube in the same manner, in order to get all traces of the sample into the tube. The total volume of the acid layer over the mercury should be about 6–10 cc. The measuring tube is now removed from its clamp and, while the stopcock is carefully held closed with one hand, brought to a nearly horizontal position so that the acid layer moves toward the other end of the tube. Before the acid reaches the rubber tube connection, the

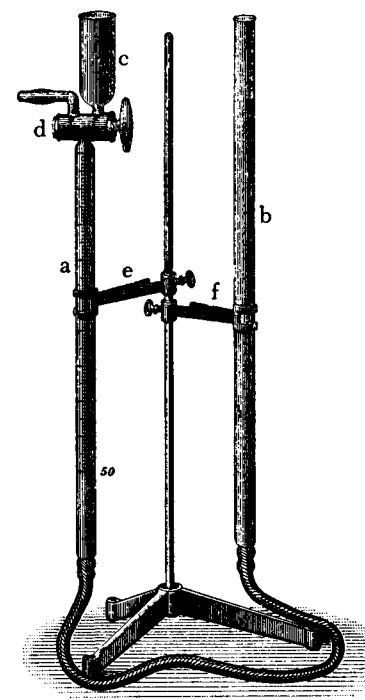

Fig. 10. The Lunge nitrometer.

tube is quickly righted while being shaken so that the acid passes through the mercury up the tube. This operation of inverting and righting the tube is continued for about 5 minutes in a manner to bring about the most intimate contact between the acid and the mercury. If the original sample contained nitric acid, gas bubbles soon begin to form and collect over the acid. When the volume of gas no longer increases, the measuring tube is replaced in the clamp, and the leveling tube is positioned so that the top of the mercury column in it stands higher than that in the measuring tube by about one-seventh or one-eighth of the height of the acid layer (ratio of sp.gr. of mercury to sul-

furic acid = $13.6 : 1.84 = 7.4$). The volume of gas over the acid is read, then the shaking operation is repeated for a few minutes and the volume is read again to ensure that the gas volume is no longer increasing.

If a relatively large amount of nitric acid is present in the nitrating mixture being tested, the gas formation starts to take place very soon after shaking is begun, and the gas bubbles assist greatly in mixing the mercury and acid layers, so that the reaction is soon completed. If, on the other hand, only a little nitric acid is present, a considerable time may elapse before the first gas bubbles are formed. In these cases, shaking must be continued uninterruptedly for at least 5 minutes before all the nitric acid is decomposed.

The amount of nitric acid in the sample of nitrating mixture is calculated from the volume of NO in the following manner: If an exact determination is desired, the temperature and barometric pressure must be taken at the time the volume of NO is read, and the gas volume corrected to 0° and 760 mm. pressure; this volume is multiplied by 1.3402 (weight in milligrams of 1 cc. NO at 0° and 760 mm.) to obtain the weight of NO in milligrams. Such high precision is not necessary in controlling nitrations; hence the corrections can be dispensed with, and the weight of NO calculated on the basis of an average laboratory temperature of 20° and average barometric pressure, according to the values given in the following table:

Barometric pressure, mm.	700	710	720	730	740	750	760	770
Mg./cc. NO at 20°	1.15	1.17	1.18	1.20	1.22	1.23	1.25	1.26
Mg. HNO ₃ corresponding to 1 cc. NO	2.41	2.45	2.48	2.52	2.55	2.59	2.62	2.66

The weight of NO is multiplied by 2.1 to give the weight of HNO₃, since HNO₃ : NO = 63 : 30 = 2.1. The bottom line in the table gives the weight of HNO₃, thus calculated, corresponding to 1 cc. NO at the various pressures. Multiplication of this weight of HNO₃ per cubic centimeter NO by the volume of NO gives the weight of HNO₃ in the weighed out sample. One has only to multiply this latter weight by the total weight of the nitration mixture and divide by the weight of the sample to get the total weight of HNO₃, in milligrams, in the nitration mixture.

The nitrometer test is usable only for nitrations which are carried out in concentrated sulfuric acid solution. It is to be noted that nitrous acid and nitrosylsulfuric acid also generate NO in the nitrometer. If, as is often the case, nitration is accompanied by some oxidation, the HNO₂ formed is determined along with the HNO₃. On the other hand, this reaction of nitrous acid makes it possible to use the nitrometer in

controlling diazotization and nitrosation reactions when these are run in concentrated sulfuric acid solution.

3. Aniline from Nitrobenzene

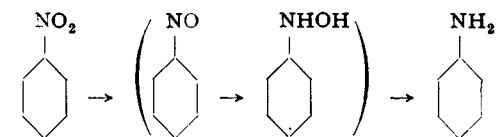

Reduction of nitrobenzene to aniline is carried out in a copper or iron vessel which is tightly covered and equipped with a stirrer reaching to the bottom of the vessel. In the laboratory, a kettle such as the one shown in Figure 11 is commonly used. In the apparatus, fitted with reflux condenser and dropping funnel, are placed 200 grams of cast iron shavings ground to a fine powder, 300 cc. water, and 20 cc. 30 per cent hydrochloric acid. The mixture is boiled for 10 minutes to etch the iron, and then, with continuous stirring (the iron must be thoroughly stirred up), 123 grams (1.0 mole) of nitrobenzene is added over a period of 45 minutes. The mixture is kept at the boiling point throughout; but since the reduction generates considerable heat, the external heating can be diminished or entirely removed. The iron is almost completely oxidized to Fe₃O₄, which deposits as a thick, easily filtered precipitate. Boiling is continued until the liquid running back from the reflux condenser is completely colorless. Then 15 grams of soda ash is carefully added to the reaction mixture (foaming!), and the aniline is distilled out with steam. Steam is introduced through one of the side openings, the condenser is connected to the main opening by means of a bent glass tube which should be at least as wide as the steam tube, and the third opening is plugged.

Aniline is somewhat soluble in water (3.0 grams in 100 grams of water); therefore enough salt should be added to the distillate to make it a 20 per cent salt solution in which aniline is very insoluble. After standing for several hours, the aniline can be separated in a separatory funnel and distilled over a free flame (see Fig. 7, page 71). The first fraction, containing traces of benzene and some water, is removed, and the main fraction is collected, about 99 per cent boiling at 182°C . The yield of aniline from 123 grams of nitrobenzene is about 85 grams, or 91 per cent of the theoretical amount.

Technical Observations. In large scale operations, the aniline is distilled with steam which is already saturated with aniline. This is done by feeding the steam kettle with the waste water from the steam distillation process. In the Weiler-Ter

Meer process, the aniline water is simply extracted with nitrobenzene which removes the aniline completely, and then the aniline-nitrobenzene solution is reduced directly. This process avoids the disadvantages attending the use of aniline water in the steam kettle.

In the industrial preparation of aniline, the iron is added gradually and less water is used.²¹ The yields obtained are practically quantitative; about 110 kilograms of pure aniline from 100 kilograms of benzene. The aniline is vacuum distilled in batches of 10,000 to 30,000 kilograms, the heat being supplied by a system of steam coils inside the kettle.

In recent times, the reduction of nitrobenzene to aniline by hydrogen or water gas, in the presence of suitable catalysts, has been introduced. Compared to the iron reduction method, the catalytic method has the advantage of being a continuous process and therefore requiring a considerably smaller apparatus for the same production.²²

It should be mentioned incidentally that alkali metal sulfides can also be used as reducing agents for this purpose if they happen to be available cheaply.

An important new process for the production of aniline, originating with Dow Chemical Company, has attained great significance. Dow Chemical Company produces large quantities of aniline (also phenol by an analogous method, see page 88) from chlorobenzene and ammonia. The reaction is carried out at very high pressure (up to 340 atmospheres) and temperatures (340°), forming aniline and ammonium chloride.

The coal tar dye industry received its first stimulus when the manufacture of aniline was started — first in England — and aniline has remained one of its most important products. A considerable amount of aniline is still used today in the production of aniline black on the fiber. Large quantities are also used in the preparation of dyes of various classes, either directly or after conversion into numerous other intermediates. Aniline is also an important starting material in the preparation of pharmaceutical products. Apparently, the largest consumer of aniline derivatives in modern times, however, is the rubber industry, which uses huge quantities of diphenylguanidine, thiocarbanilide, and other sulfur containing aniline derivatives as vulcanization accelerators.

Aniline and nitrobenzene, and many of their homologs and substitution products, are *strongly poisonous*. They produce the so-called "aniline poisoning" which is a blood poisoning accompanied by cyanosis (i.e., blue coloration of the skin, especially noticeable around the lips and finger nails, due to an excess of CO₂ in the blood). These compounds are especially dangerous because they can be absorbed not only through the stomach, but also through the respiratory system, and even through the skin. In all plants where these products are made or worked with, therefore, good ventilation and efficient removal of dust and vapor should be provided, and the greatest cleanliness should be practiced (washing of hands before meals, bathing and laundering of clothing after each work day). More malignant than the acute poisoning and cyanosis is cancer of the bladder (more recent experience indicates that β -naphthylamine is chiefly responsible for the origin of cancer of the bladder) which often occurs after many years of working in an aniline plant and is not generally recognized until it is too far advanced to be remedied. In addition to the precautionary measures already mentioned, the workers in aniline plants should be under constant medical supervision, and should be transferred to nonhazardous work at the first sign of impairment of health.

²¹ For the construction of industrial equipment, see, for example, Ullmann, *Enzyklopädie der technischen Chemie*. 2nd ed., Vol. 1, Urban und Schwarzenberg, Berlin, 1928, pp. 465 and 467.

²² See, for example, I.G., Ger. Pat. 436,820 [*Frdl.*, 15, 391 (1928)].

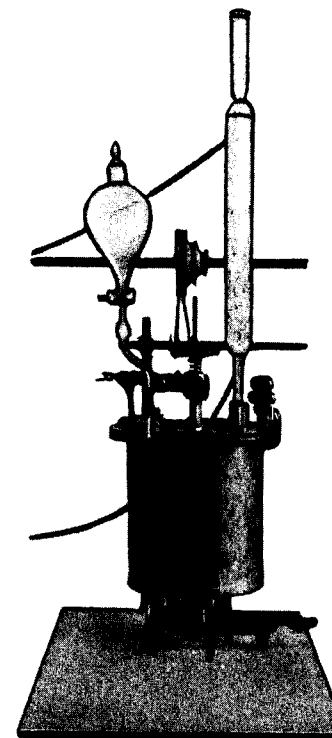

Fig. 11. Closed, coppered reduction vessel fitted with stirrer, dropping funnel, and reflux condenser, for use with substances volatile with steam.

Reduction in General

The reduction method described above, using iron in the presence of a small amount of acid, was originated by Béchamp and Brimmeyr and is the most widely used technical reduction method. In general it runs very smoothly, provided that the following conditions are adhered to:

1. The reaction vessel must be metal. Only wrought iron is used industrially, but in the laboratory copper vessels can be used to advantage. Glass, porcelain, and enameled vessels are not usable. However, if it is desired to use such vessels in the laboratory, a small quantity of a soluble copper salt must be added. Then metallic copper deposits on the surface of the iron and this appreciably increases the reactivity of the iron.

2. The iron used in the reduction must be *cast iron*. Borings or shavings are washed with an organic solvent to remove grease, then they are ground to a fine powder in a ball mill. For sensitive reactions, it is recommended that the iron powder be screened to remove the larger particles. Wrought iron waste, nails, and the like are not usable.

3. The stirrer must extend to the bottom of the reaction vessel and run rapidly enough to stir up the iron powder despite its weight.

4. Precautions should be taken that the intermediate phenylhydroxylamine (see reaction above) be reduced as rapidly as possible. When working with laboratory quantities it is advisable, therefore, to add the nitro compound slowly to the reaction mixture so that each portion is reduced to the amine stage as rapidly as possible. The reverse procedure is often used in large scale operations where longer reaction times are undesirable.

The reduction of nitrobenzene proceeds through the intermediate steps of nitrosobenzene and phenylhydroxylamine, as shown in the reaction above. Although nitrosobenzene is reduced so rapidly that it can scarcely be isolated, phenylhydroxylamine can be obtained in good yield as the main product under suitable reduction conditions. Phenylhydroxylamine is also easily reduced to aniline, but it undergoes other transformations very easily too. Thus, it condenses extremely easily with nitrosobenzene to form azoxybenzene, especially in the presence of alkali (see preparation of benzidine, page 124), or reacts with itself to form azobenzene (yellow coloration!). These products, on continued reduction, yield hydrazobenzene and finally aniline; the reductions, however, are often much slower and less smooth than the direct reduction of the hydroxylamine to aniline. In order to avoid these side reactions the reduction mixture must be kept acid at all times, even if only weakly so. On the other hand, phenylhydroxylamine can be rearranged to *p*-aminophenol by dilute sulfuric acid, or converted to halogenated derivatives by the action of halogen acids. Hence, the surest method for obtaining smooth reduction is to use acetic acid in the reaction. Equally good results are obtained in many cases by the use of hydrochloric or sulfuric acid in sufficient dilution. The nature of the acid and the optimum amount must be determined for each individual case.

It is frequently advantageous to use somewhat more acid in the laboratory than is used in technical operations, perhaps up to one-half equivalent per mole of nitro compound. If too much acid is used, however, too much of the iron goes into solution and then, when the reaction mixture is made alkaline, a voluminous precipitate of iron hydroxide is formed, making filtration very difficult.

The Béchamp-Brimmeyr reduction is usually carried out at the boiling temperature, but with especially sensitive substances (for example, *p*-nitrosodimethylaniline) a temperature of 80° is used. The reaction generates heat and the externally applied heat is regulated so that too vigorous boiling does not occur. Severe foaming occurs in many of the reductions. In these cases, the reaction vessel is filled no more than half full, and the nitro compound is added very slowly and carefully; if the mixture still threatens to foam over, the foam is broken by being sprinkled with a few drops of cold water.

Working up of the reaction mixture varies according to the nature of the reduction product. If the product is volatile with steam, the reaction mixture is made alkaline and the product separated by steam distillation. In other cases, the reaction mixture is filtered with suction after having been made alkaline. Then water or alkali soluble amino compounds, especially sulfonic and carboxylic acids, are found in the filtrate, from which they may be isolated by acidifying, salting out, or evaporation. Alkali insoluble bases remain in the iron sludge and must be separated from it by extraction with a suitable organic solvent. Frequently the reduction mixture, after removal of the iron, can be used directly in the next step without isolation of the reduction product.

The method described can be used also for the reduction of nitroso and azo compounds, and other substances, to amines.

The reduction of nitro compounds by iron can also be carried out in the presence of enough acid to cause all of the iron to go into solution. This procedure is used in industry in those cases where a nitro compound has been prepared in

concentrated sulfuric acid solution and cannot be separated from the acid in any simple manner. However, this procedure is advisable only when the reduction product can be isolated directly from the acid reduction mixture without precipitating the iron (see the preparation of H acid, page 211). In contrast to the first method, the high-acid reduction can be carried out very well using wrought iron scrap.

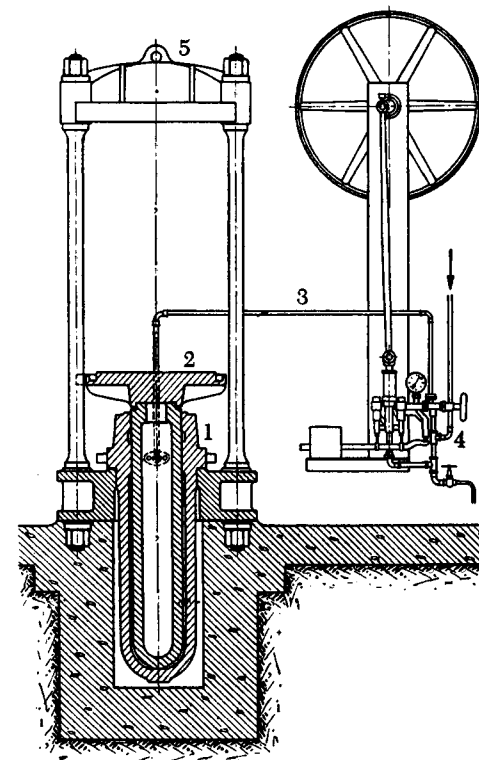

Fig. 12. Hydraulic press with automatic cut-out on pump: (1) cast steel cylinder; (2) press table; (3) inlet tube for pressure fluid (water) (250 atm.); (4) pump which cuts out at 250 atm. (the pressure can be varied by moving the weight; one pump easily serve 4 to 6 presses); (5) cast steel head-piece.

Finally, iron can also exert a reducing action when used in the presence of caustic alkali; and nitrobenzene is converted successively to azoxy-, azo-, and hydrazobenzene under these conditions. Especially finely ground cast iron powder must be used for this purpose, and it must be etched before its use in some cases.

Iron is not a suitable reducing agent for use when only one of several nitro groups present is to be reduced, or when a nitro compound is to be reduced without altering azo groups which are present. These "partial reductions" are usually carried out technically with hydrogen sulfide in the form of sodium sulfide (Na_2S) or sodium hydrosulfide (NaSH). This reduction method is not limited to partial reductions; it frequently finds use in the anthraquinone series for reducing

nitro compounds which contain no other reducible groups. It may be carried out not only in aqueous solutions but also in alcoholic solutions and is very useful, therefore, in the reduction of substances which are difficult to handle because of complete insolubility in aqueous media. For further details, see *m*-nitroaniline (page 113).

Many of the reducing agents used in laboratory work find some application in dye manufacture. The most prominent of these are zinc and zinc dust, which are usable in various reductions in acid and alkaline solution, and in hot or cold solutions. Because of their high price, however, these reducing agents are used technically only in those cases where the cheaper reagents, such as iron or sodium sulfide, either fail to work or give less satisfactory results (cf. benzidine, page 124). This applies in even greater measure to the still more expensive reagents, tin and stannous chloride, which are used industrially only in exceptional cases.

Sodium hydrosulfite ($\text{Na}_2\text{S}_2\text{O}_4$) is also a very good reducing agent (see page 157), but its general technical use is also excluded on the basis of cost. Nevertheless, hydrosulfite is a valuable reducing agent for special purposes, especially in the preparation and application of vat dyes (cf. page 321). Mention may also be made of the use of hydrosulfites and sulfoxylates in the destruction of dyes in discharge printing, in stripping of dyed textiles, and in bleaching.

Sulfurous acid and its salts are inexpensive reducing agents which are, however, usable only in special cases. These reagents frequently give sulfonation simultaneously with reduction (cf. the preparation of 1-naphthylamine-2,4-disulfonic acid from 1-nitronaphthalene, and of 1-amino-2-naphthol-4-sulfonic acid from nitroso- β -naphthol, pages 178 and 201). Also, in the reduction of diazobenzene to phenylhydrazine, a *N*-sulfonic acid is formed first and this must be split by vigorous treatment with hydrochloric acid (see pages 96 and 128).

Reduction by glucose and alkali is used only in a very special field: the reduction of nitro compounds to azoxy and azo compounds.

It should also be mentioned that electrolytic reduction and reduction with molecular hydrogen in the presence of suitable catalysts are also used in the dye industry in isolated instances.

4. Benzenesulfonic Acid

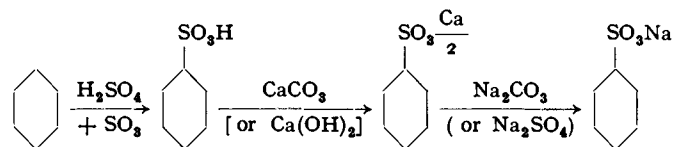

In an iron, porcelain, or enameled vessel provided with stirrer and reflux condenser, 200 grams of benzene is mixed carefully over a period of about 30 minutes with 450 grams of oleum containing 10 per cent SO_3 . The temperature should not be allowed to rise above 75° until the mixing is complete, then it is raised to 110° . Higher temperatures are not recommended, since the formation of disulfonic acid occurs readily. (Benzenedisulfonic acid is formed more easily than the literature would indicate. See the preparation of benzene-*m*-disulfonic acid, page 143.) After about 1.5 to 2 hours, the benzene has all disappeared.

The sulfonation mixture is poured into 1000 cc. water and neutralized, while boiling and stirring vigorously, with about 450 grams of pulverized chalk or the equivalent amount of slaked lime.

For laboratory purposes, the use of calcium carbonate is preferred because the CO_2 which is generated gives good mixing and an excess of the insoluble carbonate does no harm. If the container is sufficiently large and the operation is conducted carefully, foaming-over can be avoided without difficulty. Lime, on the other hand, tends to form hard lumps which are only slowly broken up by the usual laboratory stirrers, so that it is easy to add too much and a subsequent neutralization of the excess is required.

The opposite situation prevails in industrial operations. Here, strong foaming is much more troublesome than in the laboratory, and breaking up lumps of lime offers no difficulty with the much more efficient large scale stirring apparatus. Hence in plant operations, the bulk of the acid is neutralized with slaked lime, and, in those cases where an alkaline solution must be avoided, only the last part is neutralized with chalk.

The neutral solution of the calcium salt is filtered through a large suction funnel (Fig. 13) to remove the calcium sulfate, and the latter

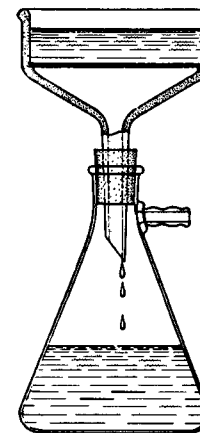

Fig. 13. Laboratory suction filter.

is washed thoroughly with water. The combined filtrate and washings total about 1500 cc. The calcium salt is now converted into the sodium salt by the addition of enough sodium carbonate to make the solution just alkaline to phenolphthalein (about 110 grams of soda ash). (Sodium sulfate can be used instead of sodium carbonate.) The material is satisfactory for use in the preparation of phenol if about 99 per cent of the sulfonate is present as the sodium salt. The hot solution of the sodium salt is filtered to remove the precipitated CaCO_3 , and the clear filtrate is evaporated over a free flame until crystals of sodium benzenesulfonate begin to separate. On cooling this concentrate, a paste is formed,

consisting of about 50 per cent solid material. The solid material consists of 90 per cent benzenesulfonate, 7 per cent sodium sulfate and carbonate, and a small amount of calcium salts. The paste can be used directly in the preparation of phenol by alkali fusion (see next preparation).

If the sodium benzenesulfonate is to be isolated, the mixture is evaporated to dryness on a water bath. If it is desired to have the product as free as possible from inorganic salts, the paste may be filtered and the precipitate dried. This procedure entails considerable loss, of course.

Technical Observations. In large scale production, quantities of benzene up to 1200 kilograms are sulfonated at one time. The gypsum is usually separated from the liquid by means of rotary filters similar to those used in soda manufacture. The specific gravity of the sodium salt solution is about 8–10° Bé, and after concentration, about 25° Bé (temperature 100°C.).

Benzenesulfonic acid can also be obtained by an entirely different process. Instead of sulfonating in the liquid state, benzene vapor can be passed through sulfuric acid of 66° Bé at 100–140°. The water formed is continuously distilled out along with some unchanged benzene, so that at the end of the reaction there is obtained a solution of benzenesulfonic acid containing very little sulfuric acid. This solution can be neutralized directly with soda, without liming, and the product fused with caustic soda. Toluene can also be sulfonated smoothly by this method. This new process was discovered by the Bakelite Corporation.

Sulfonation in General

Like halogenation and nitration, sulfonation is of the greatest importance in dye manufacture. Most of the water soluble dyes owe their solubility to the presence of sulfonic acid groups. In addition, sulfonic acids are extremely important intermediates in the preparation of phenols, especially those of the naphthalene series.

The majority of sulfonation reactions are effected by treatment with sulfuric acid, either ordinary concentrated sulfuric acid, 100 per cent sulfuric acid, or fuming sulfuric acid (oleum) of various SO₃ content. The reaction temperature to be maintained varies between wide limits – 0° to about 200° – depending on the reactivity of the starting material. Sulfonation occurs more easily in the naphthalene series than in the benzene series, but more difficultly with anthraquinone. It is greatly facilitated by the presence of phenolic hydroxyl groups and, to a smaller extent, by alkoxy, amino, and acylamino groups. Alkyl groups also have a similar, but quite small, effect. On the other hand, sulfonation is made more difficult by the presence of halogen, carboxyl, carbonyl groups, other sulfo groups, and especially by nitro groups. Dinitro derivatives of hydrocarbons, in general, cannot be sulfonated. In the sulfonation of sulfonic acids, it is frequently advantageous to use the alkali metal salt instead of the free acid; moreover, the addition of Glauber salt often makes the reaction run more smoothly. The temperature at which sulfonation is carried out often influences the position taken by the sulfo group, especially in the naphthalene series (see the section on orientation rules.) In these instances, an already formed sulfonic acid can be more or less completely isomerized, forming a state of equilibrium characteristic of the particular temperature. This behavior has great practical significance in the naphthalene series.

This rearrangement is usually explained by assuming that the sulfo groups are split out at elevated temperatures, with the establishment of an equilibrium such as:

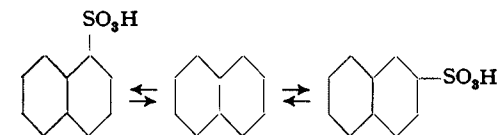

Now, experience has shown that splitting out of sulfo groups from naphthalene compounds, as well as their replacement by hydrogen, by the action of hot aqueous sulfuric acid, and their replacement by hydroxyl in alkali fusions, takes place more easily with the α -sulfonic acid than with the β isomer. Accordingly, the apparent wandering of a sulfo group usually, but not always, occurs from an α to a β position. It should be emphasized, however, that migrations of a sulfo group from one α position to another (e.g., 1-naphthylamine-8-sulfonic acid \rightarrow 1,4 isomer \rightarrow 1,5 isomer), or from one β position to another (e.g., 2,7-naphthalenedisulfonic acid \rightarrow 2,6 isomer), have been observed.

In the anthraquinone series, the presence of mercury salts favors sulfonation in the α -position.

Since water is formed in the sulfonation reaction and dilutes the sulfuric acid, an appreciable excess of the acid is always necessary in order that its concentration be maintained sufficiently high throughout the reaction. When sulfonation is done with oleum, usually only the SO₃ is used up, so that at the end of the reaction a large excess of sulfuric acid remains. The separation of the sulfonic acid product from the excess sulfuric acid is simplest in the case of sulfonic acid derivatives of amines. These compounds, if they contain an equal number of sulfo and amino groups, are generally so difficultly soluble in water, and particularly in dilute sulfuric acid, that they are almost completely precipitated on dilution of the sulfonation mixture, and need only to be filtered off and washed.

Polysulfonic acid derivatives of monoamines, on the other hand, behave like the sulfonic acid derivatives of hydrocarbons; usually their acid salts, in which one sulfo group is free and the others are present as alkali metal salts, are salted out quite easily. Monosulfonic acid derivatives of polyamines are, like the free amines, soluble in excess mineral acid (cf. page 33).

Two general methods are employed technically for the isolation of other sulfonic acids. The first method involves neutralizing the diluted sulfonation mixture with Ca(OH)₂ (slaked lime, milk of lime) or with CaCO₃ (chalk or finely powdered limestone) and filtering off the precipitated CaSO₄. The calcium salt of the sulfonic acid, left in the filtrate, is converted to the sodium salt by the addition of soda or Glauber salt, the precipitated CaCO₃ or CaSO₄ is filtered off, and the resulting solution of the sodium sulfonate is evaporated until crystallization occurs, or if necessary, until dry. (Alternatively, the sulfonation mixture may be treated at the outset with the necessary amount of Glauber salt to form the sodium salt, and then lime is added, whereby a solution of the sodium sulfonate is obtained directly after filtering off the CaSO₄.) This process, technically referred to as "liming", is usable with all sulfonic acids except those that form difficultly soluble calcium salts; it is, however, an inconvenient and rather costly process because it requires a large volume of liquid which must ultimately be evaporated. It is usually preferable, therefore, to use the second general method in which the diluted sulfonation mixture is treated with an inorganic salt (usually NaCl or Na₂SO₄, less often, KCl or (NH₄)₂SO₄) in order to salt out the corresponding salt of the sulfonic acid. This method is not always possible since not all sulfonic acids can be precipitated sufficiently completely. Also it must be remembered that sulfonates isolated

in this way are, as a rule, contaminated with some of the inorganic salt used in the precipitation. This contamination may not interfere with the use of the product, however.

Aromatic amines can often be sulfonated advantageously by a special method applicable only to these compounds. The method involves dry heating of the acid sulfate of the amine (containing 1 mole of H_2SO_4 for each amino group) to temperatures of about $170\text{--}220^\circ$, suitably in vacuum. By this so-called "baking process," the sulfonic acid group is always introduced ortho or para to the amino group, even with polynuclear substances. This method may be used, therefore, to prepare pure sulfonic acids in those cases where other methods lead to mixtures of isomers. Thus, α -naphthylamine gives exclusively 1-naphthylamine-4-sulfonic acid by the baking process, whereas other methods give mixtures of the 1,4 and 1,5 isomers. The baking process is also valuable in cases where the desired isomer is not formed at all by other methods, as in the case of *m*-xylidine. Here, the baking process introduces the sulfo group ortho to the amino group, but other methods put it in the meta position because of the orienting influence of the two methyl groups:

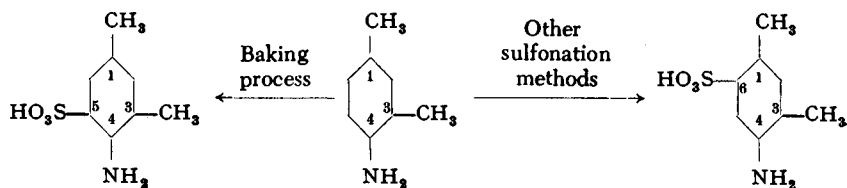

For further details of the baking process, see sulfanilic acid (page 126) and naphthionic acid (page 180).

The unavoidable excess of sulfuric acid in sulfonation reactions using sulfuric acid or oleum causes, under some conditions, such undesirable side reactions as further sulfonation or rearrangement of the sulfonic acid formed initially. These difficulties can be avoided by effecting the sulfonation with the calculated quantity of chlorosulfonic acid in an organic solvent which is not attacked by this reagent (usually nitrobenzene). For further details on this method, see the preparation of 2-naphthol-1-sulfonic acid, page 199.

If sulfonation is done with a large excess of chlorosulfonic acid without a solvent, the sulfochloride is formed, as a rule, instead of the free sulfonic acid. For example, large quantities of the mixture of *o*- and *p*-toluenesulfonyl chlorides are prepared in this way:

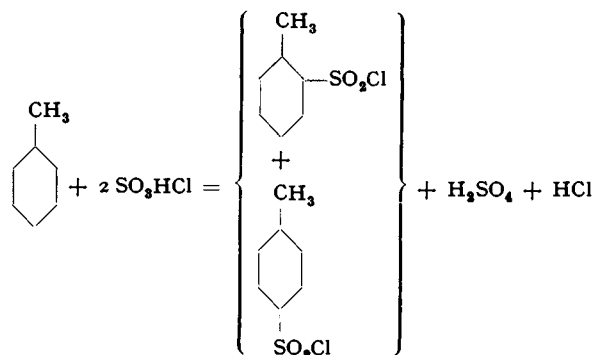

The ortho compound is used in the manufacture of saccharin, while the para compound, which was formerly regarded as a bothersome by-product, has more recently found many uses in dye manufacture and in the pharmaceutical industry.

In sulfonation reactions with chlorosulfonic acid, as well as with sulfuric acid and oleum, small amounts of sulfones are often formed as by-products. The sulfone is formed by the reaction of the sulfonic acid with unchanged starting material under the influence of the dehydrating action of the sulfonation reagent, according to the equation:

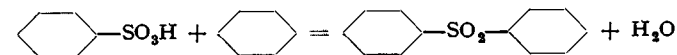

Compared with direct sulfonation, the indirect introduction of sulfo groups is of less importance in dye chemistry, although it is used in the preparation of a few technically important compounds. The methods used technically are:

(1) Replacement of an "active" halogen by a sulfo group by treatment with sodium sulfite. The "active" halogen may be aliphatically bound, as in benzyl chloride, or it may be in an aromatic nucleus and activated by negative substituents, such as nitro groups. Examples include the preparation of 2,4-dinitrobenzenesulfonic acid from 2,4-dinitrochlorobenzene (page 103) and the preparation of nitrobenzene-2,5-disulfonic acid from *o*-nitrochlorobenzene-*p*-sulfonic acid (page 106).

(2) Action of bisulfite on a nitro compound or on a quinone or quinonemoxime, in which the nitro and nitroso groups are simultaneously reduced to amino groups. Examples are the preparation of 1-naphthylamine-2,4-disulfonic acid from α -nitronaphthalene and bisulfite (naphthionic acid as by-product), and the manufacture of 1-amino-2-naphthol-4-sulfonic acid from nitroso- β -naphthol and bisulfite (page 201).

(3) Oxidation of a sulfinic acid, a mercaptan, or a disulfide. For example, the chlorine in *o*-nitrochlorobenzene is not reactive enough to be replaced directly by the sulfo group according to (1) above; the compound can be converted, however, to *o,o'*-dinitrodiphenyldisulfide by the action of Na_2S_2 , and this, in turn, can be oxidized to *o*-nitrobenzenesulfonic acid.²³ The reactions involved are:

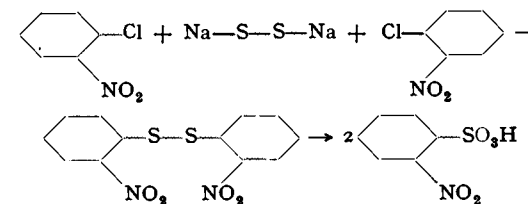

(4) Action of formaldehyde bisulfite on amines or phenols, introducing the $-\text{CH}_2\text{SO}_3\text{H}$ group into the amino group, in the first case, or into the nucleus, ortho or para to the hydroxyl, in the second. The sulfomethyl derivatives of phenols are very stable, but the *N*-sulfomethyl groups in the amine derivatives are easily split off by hydrolysis. This latter property is used in the synthesis of some azo dyes (see page 250).

²³ Fierz, Schlittler, and Waldmann, *Helv. Chim. Acta*, 12, 663 (1929).

5. Phenol

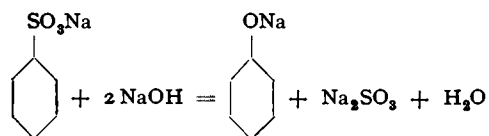

The crude paste of sodium benzenesulfonate (about 50 per cent), obtained as described in section 4 above, is used as the starting material. A test is made to determine the weight of solids in the paste, assuming arbitrarily that the solid substance is pure sodium benzenesulfonate. It is theoretically possible to fuse 2.25 parts of sodium benzenesulfonate with 1 part of caustic soda, but practically, only 1.65 parts can be used.

The best material for a fusion apparatus (see Fig. 14a) in the laboratory is copper, which saves on gas because of its good conductivity and which is therefore economical in operation. (It is important that the melt does not come in contact with two different metals, because then a galvanic cell is formed which causes deleterious oxidation and reduction reactions.) The high fusion temperature makes it essential that the stirrer sweep over the whole surface of the fusion vessel (see sketch). The thermometer is inserted in a copper tube closed at the end with hard solder and filled with dry cylinder oil to such a depth that at least 10 cm. of the thermometer is immersed. It may be practical also to insert the thermometer in the hollow shaft of the stirrer (Fig. 14b).

The fusion apparatus is placed directly over a small Fletcher burner and charged with 200 grams of solid (stick) chlorate-free sodium hydroxide and 100 cc. water. (Fusion with hydroxide containing chlorate lowers the yield and, moreover, is very dangerous; *explosive!*). The hydroxide is melted with a large flame, the melt becoming water-clear and foaming until the temperature reaches 270°C. The melt is heated further to 290° and then is added in small portions to the well stirred melt, the benzenesulfonate paste, corresponding to 330 grams of solid material, which is held at about 100° to keep it liquid (*caution, goggles!*). The addition, made at such a rate that the temperature inside the vessel remains at 290–300°, requires about 45 minutes.

When the addition has been completed, the temperature is raised to 325° over a period of 30 minutes, and held at this point for 40 minutes while continuous stirring is maintained, after which the melt, while still hot, is poured out onto a shallow plate. After cooling, the mass is broken up and returned to the kettle with 500 cc. water. The

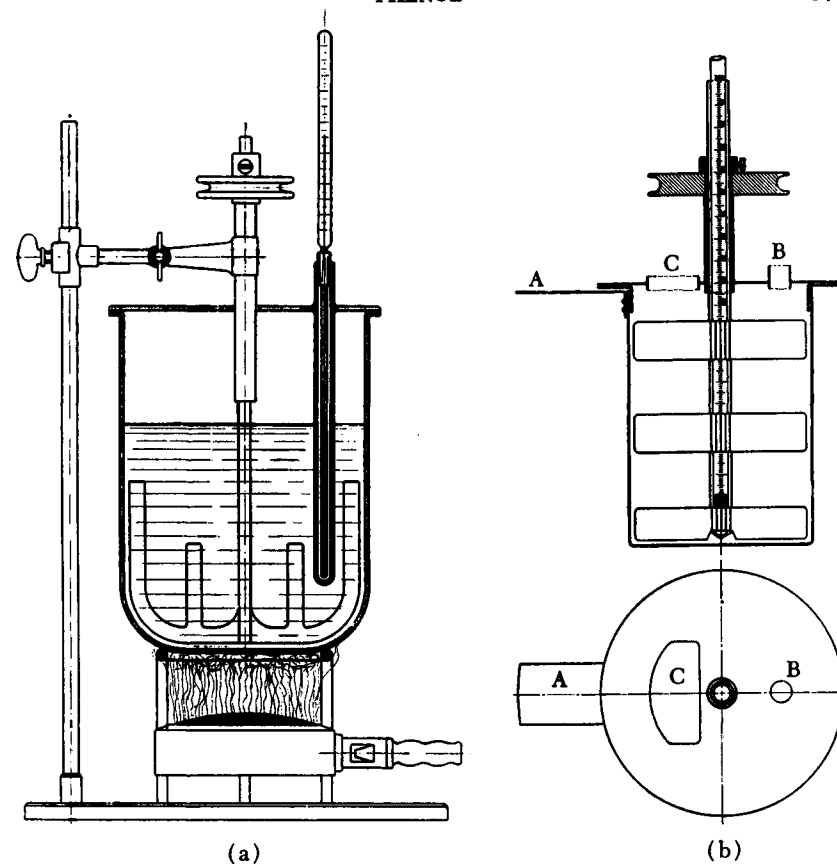

Fig. 14. (a) Fusion kettle for alkali fusions. (b) Fusion kettle with central thermometer tube: A, handle, attached by rivets, for securing the kettle; B, opening for introducing gases; C, filling port.

greater part of the material dissolves easily on careful warming, but a crust of sodium sulfite always remains undissolved. The solution is decanted, and successive additions of water are made until all of the material is dissolved. Not more than 2 liters of water should be required. The combined solutions are heated to boiling in a porcelain dish over an open flame and treated with sufficient 50 per cent sulfuric acid or concentrated hydrochloric acid to make the reaction to thiazole paper almost disappear. The solution is then cooled slightly and filtered through a large suction funnel into a warm flask, and the clear, warm filtrate is treated with stirring with concentrated hydrochloric acid until a permanent blue reaction with Congo red paper is obtained. The solution is then cooled and extracted with three 400-cc. portions of benzene to remove the phenol. The benzene is distilled off and the

phenol is fractionally distilled at ordinary pressure, or better, in vacuum. The yield amounts to as much as 85 per cent of the theoretical quantity, that is, 90 to 100 parts of phenol, melting at about 38°, from 100 parts of benzene.

Technical Observations. The fusion is carried out by direct firing in kettles having capacities up to 2400 liters. The stirrer requires 5 H.P. Fusion of the sulfonate from 1000 kilograms of benzene requires about 6 hours in all, including the mixing operation.

The phenol is not extracted, but is precipitated with sulfuric acid of 40° B \acute{e} and separated from the salt-containing mother liquor which contains less than 0.4 gram of phenol per liter. The phenol is then steam distilled. Upon concentration of this crude product by use of long rectifying columns, the phenol content—originally about 75 per cent—is brought to about 95 per cent. The remainder of the crude product is water and "salt." The Raschig column is especially useful for this purpose.

The phenol is then distilled in vacuum. The forerun, as well as the water separated from the crude phenol, contains a considerable amount of phenol and is used in the next fusion run. The residue is also returned to the process so care is taken not to char it. The boiling point of phenol is about 186°C. at 760 mm.

Recording thermometers are frequently used, affording excellent control of the process.

Phenol is also prepared technically by an entirely different method in which chlorobenzene is reacted with sodium hydroxide in the presence of copper at very high temperatures (about 340°) and pressures (about 320 atmospheres). This process is operated on a very large scale by Dow Chemical Company.²⁴ It has already been mentioned under aniline (page 76) that an analogous reaction between ammonia and chlorobenzene is used in preparing aniline.

Alkali Fusion in General

Alkali fusion brings about the replacement of a sulfo group in an aromatic nucleus by hydroxyl, and thus affords a synthesis for numerous technically important phenols and phenol derivatives. Particularly in the naphthalene series, alkali fusion is one of the most frequently used operations, along with sulfonation, nitration, and reduction.

There are two essentially different methods for carrying out alkali fusions in practice. The first method, as in the example given above, uses *molten*, dry, or almost dry, caustic soda in an open container. The other method employs an aqueous alkali *solution*, whose concentration may vary between wide limits, and the necessary high temperatures are obtained by working in autoclaves (see temperature-pressure curve, Fig. 15). The second method has the advantage that the reaction can be controlled more accurately, and the optimum conditions for each particular sulfonic acid can be arrived at by a suitable choice of alkali concentration and temperature. In addition, any deleterious action of oxygen at the high temperature is minimized by working in an autoclave. For this reason, purer products and better yields are often obtained in the autoclave reactions, particularly where sensitive substances are involved. Fusion in open kettles is less expensive, however, and is preferable if it gives as good results as can be obtained in an autoclave.

Sodium hydroxide is generally used as the alkali, for reasons of cost. There are cases, however, where good results are obtained only with potassium hydroxide,

²⁴ Hale and Britton, *Ind. Eng. Chem.*, 20, 114 (1928).

which melts more easily and is more active. Sometimes a mixture of potassium and sodium hydroxides is used because of its still lower melting point.

The reaction of di- and polysulfonic acids can usually be carried out so that the replacement of the sulfo groups by hydroxyls takes place stepwise (partial alkali fusion). Thus, phenol-*m*-sulfonic acid is obtained from benzene-*m*-disulfonic acid under mild conditions, while resorcinol is formed under more vigorous conditions (see page 144); similarly, naphthalene-1,5-disulfonic acid yields, first, 1-naphthol-5-sulfonic acid, then 1,5-dihydroxynaphthalene, both valuable azo dye

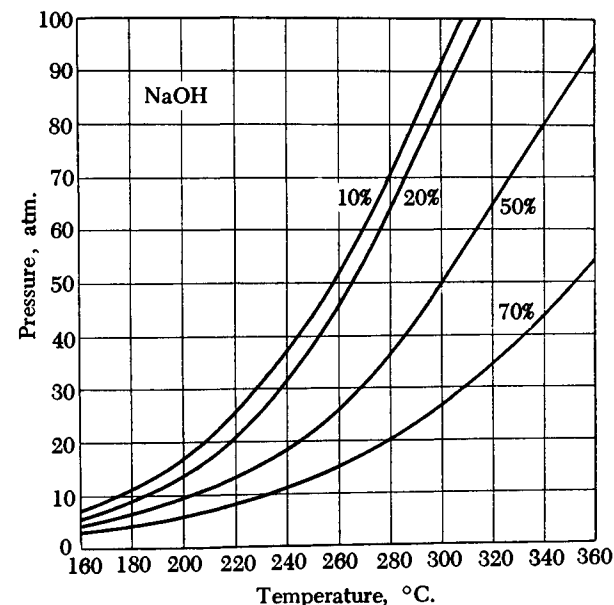

Fig. 15. Temperature-pressure curves for aqueous sodium hydroxide solutions.

components. In the naphthalene series, partial alkali fusion attacks the sulfo group in the α -position first. The technically very important 2,5,7-, 2,8,6-, 1,8,4-aminonaphtholsulfonic acids and the 1,8,3,6-, 1,8,4,6-, and 1,8,2,4-aminonaphtholdisulfonic acids are produced in this way from the corresponding naphthylaminedi- and -trisulfonic acids.

Of the side reactions which frequently occur in alkali fusions, the following might be mentioned:

(1) Replacement of the sulfo group by hydrogen instead of by hydroxyl, simultaneously forming sulfate instead of sulfite. This reaction is usually only an unimportant side reaction, but in certain cases it may become the main reaction. Thus, alkali fusion of 2,3-dihydroxynaphthalene-6-sulfonic acid does not give the expected 2,3,6-trihydroxynaphthalene, but instead, 2,3-dihydroxynaphthalene.

(2) The sulfite formed can exert a reducing action when easily reducible groups are present. For this reason, alkali fusion of nitrosulfonic acids rarely works well. Sometimes this reducing action can be counteracted, especially in the anthraquinone series, by the addition of an oxidizing agent or an alkaline earth hydroxide; in the latter case, the sulfite is precipitated as an insoluble salt and thus rendered harmless.

(3) The molten alkali can have the opposite effect and exert an oxidizing action. Thus, it is well known that anthraquinone- β -sulfonic acid does not yield β -hydroxyanthraquinone, but alizarin (1,2-dihydroxyanthraquinone). This reaction can be favored by the addition of an oxidizing agent.

(4) Other substituents, in addition to sulfo groups, may be replaced by hydroxyl. This is especially true for amino groups. If this reaction is undesirable, it must be minimized by using mild conditions, avoiding unnecessarily high temperatures.

As mentioned before, halogen atoms (practically only chlorine) as well as sulfo groups can be replaced by hydroxyl by means of alkali fusion. This reaction is accelerated by copper. Whether a given phenol can be prepared better from the sulfonic acid or from the chloro derivative depends on which of the two starting materials is more easily and cheaply made.

Alkali fusion is useful not only for preparing phenols, but also for effecting many condensation reactions, particularly those involving ring closures. Examples of these are the synthesis of indigo from phenylglycine or phenylglycine-*o*-carboxylic acid, the preparation of indanthrene from β -aminoanthraquinone, and the preparation of dibenzanthrone from benzanthrone. In order to get good yields in these condensation reactions, it is frequently necessary to exclude all water and also to take up the water formed in the reaction immediately, for example, by means of sodium amide or quicklime. When quicklime is used, the reaction mixture does not melt completely but only sinters (sinter-fusion). The removal of the water formed in the reaction can also be accomplished by working under vacuum or by passing through a stream of some indifferent gas.

6. Derivatives of Chlorobenzene

o- and *p*-Nitrochlorobenzene

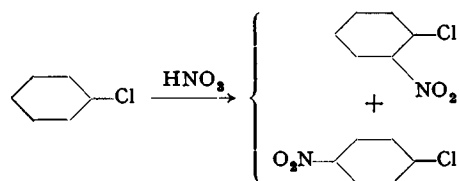

Nitration of chlorobenzene always gives a mixture of about one-third *o*-nitrochlorobenzene and two-thirds *p*-nitrochlorobenzene. The bulk of the para compound crystallizes out on cooling and can be obtained simply by centrifuging. The residual mixture cannot be separated into its constituents by fractional distillation alone because the boiling points lie too close together. However, careful fractionation through an efficient column yields a first fraction enriched in the para isomer, and a last fraction enriched in the ortho isomer. The pure compounds can be isolated from these by cooling and crystallizing, and then centrifuging.^{24a} In large scale operations, the noncrystallizing middle fraction, and the eutectic mixture from the centrifuging operation, are put back in the process so that the separation is finally complete. In laboratory operations, one must be satisfied with the isolation of the chief fraction of the para compound and a portion of the ortho isomer.

^{24a} Chem. Fab. Griesheim, Ger. Pat. 97,013 (1896) [*Frdl.*, 5, 47 (1897-1900)].

112 grams (1 mole) of chlorobenzene is heated in an enameled nitrating kettle or a round-bottomed flask on a water bath to 40°C. With vigorous stirring, mixed acid containing 60 grams of sulfuric acid (66° Bé) and 68 grams of nitric acid (sp.gr. 1.52) is added dropwise while the temperature is maintained between 40 and 50°. If the temperature goes much higher, some dinitro compound is formed. Addition of the acid requires about 10 minutes, and stirring is continued for an additional 2 hours, during which time the temperature of the reaction mixture drops slowly. The mixture is now poured out onto ice, while stirring with a glass rod from time to time and keeping the temperature at 0° by addition of more ice. After standing for a long time, the pasty precipitate is filtered off with suction, washed with cold water, and pressed as dry as possible. It is then centrifuged at about 15° until no more liquid is expelled. The final residue is about 80 grams of practically pure *p*-nitrochlorobenzene.

The liquid centrifuged out consists of some water and the eutectic mixture consisting of about 30 per cent *p*- and 70 per cent *o*-nitrochlorobenzene. The mixture is separated in a separatory funnel, and the eutectic mixture is washed until it is neutral.

The eutectic mixture is subjected to careful fractional distillation in vacuum, using a column such as that described on page 342. After a small forerun containing water and traces of chlorobenzene, and as soon as the temperature has reached about 105° (10 mm.), the first fraction is collected until about three-fifths of the total volume has come over. This first fraction gives, on cooling and centrifuging at 15°, a few more grams of *p*-nitrochlorobenzene. The last two-fifths of the total volume is distilled preferably without a column. After cooling, this fraction yields about 10 grams of *o*-nitrochlorobenzene on centrifuging at 15°.

The liquid eutectic mixtures centrifuged out of both fractions are combined and subjected to a second fractional distillation and crystallization. This process can be repeated as often as appears profitable.

The products obtained are already very pure. If they are desired chemically pure, 1-2 cc. benzene can be sprayed in during the centrifuging. The pure compounds have the following melting and boiling points:

p-Nitrochlorobenzene: m.p., 82.5°C.; b.p. (corr.), 106° at 10 mm., 234° at 727 mm.

o-Nitrochlorobenzene: m.p., 32.5°; b.p. (corr.), 109.5° at 10 mm., 241° at 727 mm.

An accurate melting point curve of mixtures of *o*- and *p*-nitrochlorobenzenes has been given by Holleman and de Bruyn.²⁵ From this curve, it is possible to determine directly the composition of any mixture.

p- and *o*-Nitroaniline from *p*- and *o*-Nitrochlorobenzene

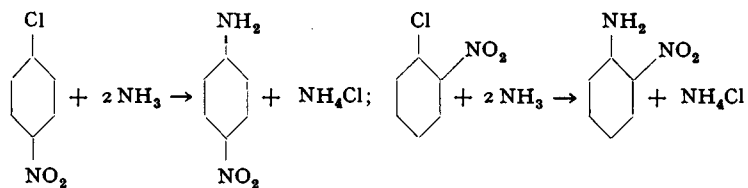

One mole of *p*-nitrochlorobenzene (or *o*-nitrochlorobenzene) is heated for 10 hours in an autoclave at 170°C. with 10 moles of 25 per cent ammonia. The pressure rises to about 35 atmospheres. After the con-

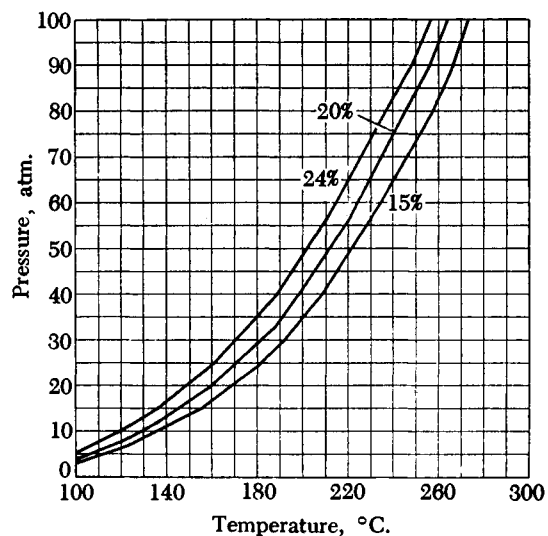

Fig. 16. Temperature-pressure curves for aqueous ammonia.

tents of the autoclave have cooled, the pressure, which is still high, is released. The nitroaniline has separated out in crystalline form, usually containing traces of unchanged nitrochlorobenzene which is removed by recrystallizing the product from boiling water. Since the nitroani-

²⁵ Holleman and de Bruyn, *Rec. trav. chim.*, 19, 192 (1900).

lines are somewhat volatile with steam and strongly poisonous, boiling is done under reflux. The yield is about 95 per cent of the theoretical amount.

Technical Observations. The procedure is different in large scale operations. As soon as the reaction is ended, the excess ammonia is blown out through a condensing system (water), and the autoclave contents, in which all of the nitroaniline remains dissolved at 150°, is put through a strong iron filter press. The nitroaniline is given no opportunity to crystallize out, but is poured directly into cold water, whereupon it crystallizes in finely divided form. This is highly desirable because it can then be diazotized smoothly in the cold.

Analogous procedures are used to prepare the nitroaniline derivatives from 1,4-dichloro-5-nitrobenzene and similar compounds. The larger the number of "negative" substituents present, the easier the conversion. The preparation of *p*-nitrobenzene-*o*-sulfonic acid (page 99) is another example.

The foregoing procedure has largely replaced the older method for preparing *p*-nitroaniline (nitration of acetanilide or formanilide, see page 131), although the total cost of the two processes is about equal. The newer procedure is better, however, not only because it yields a product completely free from isomers, but particularly because it supplies an outlet for *p*-nitrochlorobenzene which is formed in greater quantity than the ortho compound in the nitration of chlorobenzene (page 90). The large demand for the ortho compound for the preparation of *o*-nitroanisole (*o*-anisidine, dianisidine, see page 97) resulted in the formation of more *p*-nitrochlorobenzene than was needed for other purposes.

p-Nitroaniline is used chiefly for the preparation of numerous azo dyes, either in substance or on the fiber (para red). It is also used in preparing *p*-phenylenediamine and its derivatives (see next preparation). *o*-Nitroaniline is also used in the synthesis of azo dyes, but to a much smaller extent. It yields a valuable yellow dye for wool when condensed with benzaldehyde and sulfonated.²⁶

p-Nitrophenyloxamic Acid and *p*-Aminophenyloxamic Acid²⁷

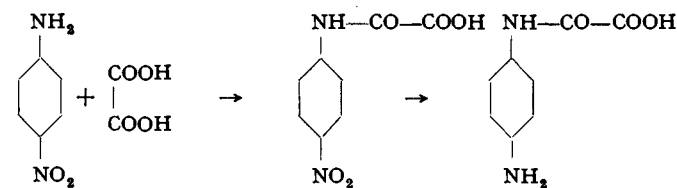

In a reaction kettle constructed as shown in Figure 36 (page 333), a mixture of 138 grams (1.0 mole) of *p*-nitroaniline and 225 grams (2.5 moles) of dry oxalic acid (anhydrous!) is heated with good stirring at 110°C. The two compounds should be finely pulverized and intimately mixed beforehand, and six steel balls of 25 mm. diameter should

²⁶ Badische A. und S. F., Ger. Pat. 289,111 (1915) [*Frdl.*, 12, 308 (1914-1916); *C.A.*, 10, 2529 (1916)].

²⁷ C. Curtis *Dissertation*, Zürich-Weida, 1929. This also gives the preparation of 1-antraquinoneoxamic acid and of indanthrene red 5 GK.

be put into the reaction kettle to ensure good mixing. The temperature is raised to 100° over a period of 2 hours, during which time the *p*-nitroaniline oxalate is formed. Thereafter the mixture is held at 110° for 12 hours with continuous stirring. The water formed is removed with a water pump, some oxalic acid being carried over with it. The end of the reaction is recognized from the fact that the reaction mixture becomes water insoluble. When this point is reached, the crude product is stirred with 1.5 liters of cold water, then filtered off from the

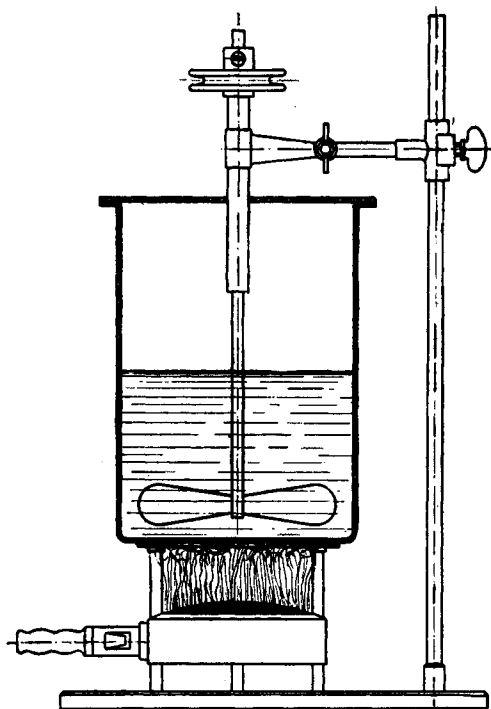

Fig. 17. Apparatus with propeller stirrer for Béchamp-Brimmeyr reductions.

oxalic acid solution. The precipitate is washed three times on the funnel with 250-cc. portions of cold water. The yield of technically pure *p*-nitrophenyloxamic acid is about 95 per cent of the theoretical amount. The product melts at 205–207°, and after recrystallization from water, at 210°.

Reduction. A mixture of 200 grams of cast iron powder (see pages 75 and 77), 1 liter of water, and 50 cc. concentrated hydrochloric

acid is heated to boiling, and to this is added, over a period of 40 minutes, 0.25 mole (one-fourth of the product obtained above) of *p*-nitrophenyloxamic acid. The solution should be kept boiling and vigorously stirred (cf. Fig. 17). The reduction is complete when a drop of the reaction mixture on filter paper shows no color. While the mixture is still boiling, 30 grams of prepared chalk is added and boiling is continued for 30 minutes to convert the product into the calcium salt. 45 grams of soda ash is now added to precipitate all the iron, and the *definitely alkaline* mixture is filtered. The iron oxide sludge is washed with 200 cc. of hot 2 per cent soda solution. Concentrated hydrochloric acid is added to the clear filtrate until the mixture is just acid to Congo red, whereupon the *p*-aminophenyloxamic acid separates as a white crystalline precipitate. After cooling, the product is filtered off, washed with cold water, and dried. The yield is about 42 grams, or 93 per cent of the theoretical amount.

p-Aminophenyloxamic acid is an important intermediate in the preparation of polyazo dyes. The oxalic acid residue, in contrast to the acetyl group, is easily removed by hydrolysis, freeing the amino group for diazotization.

p-Nitrophenylhydrazine²⁸

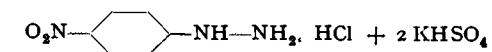
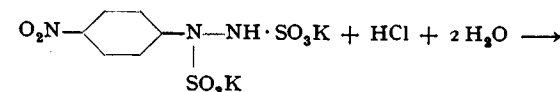
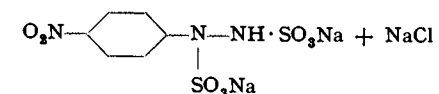
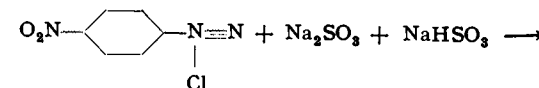
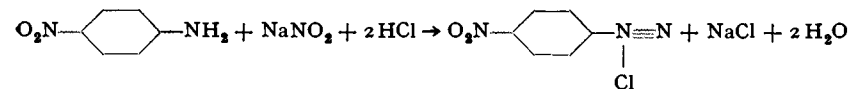

p-Nitroaniline (34.5 grams, 0.25 mole) is diazotized according to the procedure given on page 246. The diazonium solution is cooled in an ice-salt bath, and soda ash is added to it slowly, with continuous mechanical stirring, until the solution is only very slightly acid to Congo red (about 18–20 grams is required). Care should be exercised

²⁸ Bamberger and Kraus, *Ber.*, 29, 1834 (1896).

that the soda is immediately dispersed so that no portion of the solution becomes alkaline; the temperature should be kept as near to 0°C. as possible, and in no case should it be allowed to rise above 5°. The last traces of free acid are then neutralized with a small amount of sodium bicarbonate. The solution is filtered through a fluted filter to remove a few brown flocks, and the clear, light yellow filtrate is poured with continuous stirring into a solution, cooled to 10°, made by mixing 155 grams (0.55 mole) of sodium bisulfite solution (38° Bé) and 21 cc. (0.25 mole) sodium hydroxide solution (40° Bé). A clear, intensely greenish yellow solution, neutral to Congo red, is formed. Potassium chloride (120 grams) is now added to precipitate the difficultly soluble

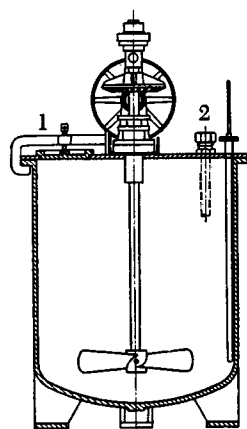

Fig. 18. Reduction kettle with auger-type stirrer: (1) filling port with clamped cover; (2) hole for blow-out tube.

potassium salt of nitrophenylhydrazinedisulfonic acid, and stirring is continued until all of the potassium chloride is dissolved. After standing overnight in a cold place to complete the precipitation, the thick yellow paste is filtered off with suction, pressed out, and washed with a cold 10 per cent potassium chloride solution. The filter cake, which should not weigh more than 170 grams when properly pressed out, is transferred to a porcelain dish and treated with 140 cc. concentrated hydrochloric acid (21° Bé), added gradually while stirring with a pestle. Stirring is continued until a completely homogeneous paste is formed, and the mixture is allowed to stand at room temperature for 4 hours. Then it is warmed on a water bath, again stirring thoroughly with a pestle, until the yellow, finely crystalline paste is converted to a coarsely crystalline, light red suspension of *p*-nitrophenylhydrazine hydrochloride. Heating on the water bath is continued for another 15 minutes, during which neither resinification nor the smell of nitroben-

zene should be noticeable. The mixture is placed in the cold chest overnight, then filtered with suction and washed with a cold mixture of equal volumes concentrated hydrochloric acid and water. The filter cake is dissolved in 300 cc. lukewarm water and filtered to remove a small residue of brown flocks; then most of the hydrochloric acid is neutralized with 25 cc. 25 per cent ammonia (the solution should still be acid to litmus; otherwise it is acidified with acetic acid). The precipitation is completed by adding a solution of 15 grams of crystalline sodium acetate in 40 cc. water. The mixture is chilled thoroughly, and the orange-red crystals are filtered off with suction. The filtrate should be tested with more acetate to see that no more precipitation occurs. The precipitate is washed with cold water and dried at about 80°C. in a steam heated drying oven.

The yield of product melting at 156–157° (sintering a few degrees lower) is about 30 grams, or 70–80 per cent of the theoretical amount. This product is suitable for most purposes without further treatment. Recrystallization from 20 parts of alcohol gives completely pure *p*-nitrophenylhydrazine in the form of slender brown plates with a bluish surface reflection, melting sharply at 157–158°.

o-Nitrophenylhydrazine is prepared in an entirely analogous manner from *o*-nitroaniline, except that here, in order to separate the potassium salt of the sulfonic acid, it is necessary to make the solution strongly acid with hydrochloric acid after the addition of potassium chloride.²⁹

In this case, the diazotization can be carried out satisfactorily according to the procedure given on page 246 for 3-nitro-4-toluidine, using 100 cc. concentrated hydrochloric acid and 120 g. ice for 0.25 mole *o*-nitroaniline.

Technical Observations. The nitrophenylhydrazines are used in preparing nitrophenylpyrazolones (page 129) which, after reduction of the nitro group to amino, are valuable components for substantive azo dyes. They can be diazotized and coupled on the fiber, or after treated with formaldehyde.³⁰

p- and *o*-Nitrophenylhydrazines are important reagents in research for the isolation and identification of aldehydes and ketones. They are especially important in sugar chemistry.

o-Nitroanisole from *o*-Nitrochlorobenzene

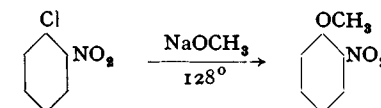

²⁹ Müller, Montigel, and Reichstein, *Helv. Chim. Acta*, 20, 1472 (1937).

³⁰ See, for example: Chem. Fab. Griesheim-Elektron, Ger. Pat. 278,871 and 278,872 (1914) [*Frdl.*, 12, 334–339 (1914–1916); *C.A.*, 9, 1847 (1915)]; M. L. B., Ger. Pat. 287,071 (1915) [*C.A.*, 10, 1933 (1916)]; Jordan and Neelmeier, Ger. Pat. 289,350 (1915) [*C.A.*, 10, 2802 (1916)]; M. L. B., Ger. Pat. 296,141 (1916) [*Frdl.*, 13, 527 (1916–1921)].

In an autoclave of 1-liter capacity, without stirrer, and heated by an oil bath, is placed 600 cc. dry methyl alcohol in which 23 grams of metallic sodium has previously been dissolved (reflux condenser), and to this is added 158 grams of pure *o*-nitrochlorobenzene (m.p. about 32°C.; b.p. 243°). The autoclave is sealed and the heating is started. The temperature is raised to 120° over a period of 1 hour, held at this point for 3 hours, and finally held at 128° for 1 hour more. The pressure is 8 to 10 atmospheres. At the end of the reaction, the methyl alcohol is blown out through the valve into a good condenser. The recovered methyl alcohol can be used without purification in a subsequent run. The reaction product is removed from the autoclave, washing the latter out with hot water to remove the sodium chloride. The crude product is washed twice with five times its volume of hot water, separated, and distilled in vacuum. The yield is 136 grams, or 88 per cent of the theoretical amount. The product boils at 141° at 15 mm.

Technical Observations. A whole series of alkyl and phenyl ethers in the benzene series (also in the naphthalene and anthraquinone series) can be prepared in an analogous manner. While anhydrous methylate gives satisfactory results in the case of nitroanisole, there are other cases (e.g., dinitroanisole from dinitrochlorobenzene) where it is better to use caustic potash, the small water content having no deleterious effect. Moreover, better results are often obtained if only 90 per cent of the calculated quantity of alkali is used.

An interesting technical example is the preparation of 1-amino-2,4-dimethoxy-5-chlorobenzene according to the following scheme:

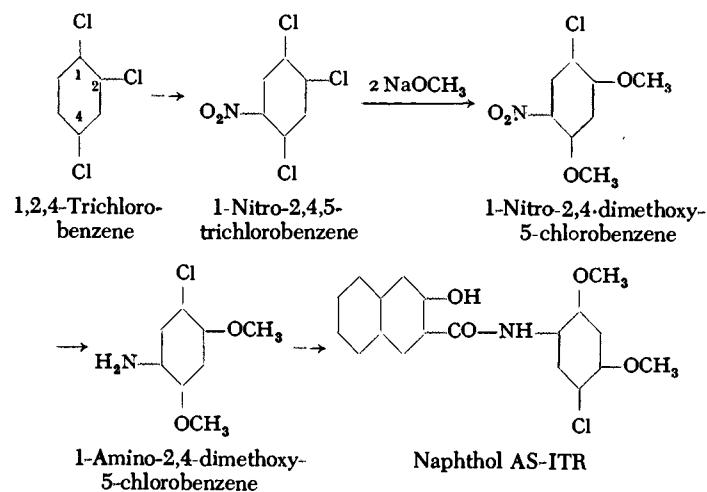

1-Amino-2,4-dimethoxy-5-chlorobenzene is used in preparing the important naphthol AS-ITR, which is used to produce turkey red shades on cotton. The

reactions above are quite similar to those used in the preparation of *o*-nitroanisole, so it is unnecessary to describe them further.

o-Nitroanisole is used in the preparation of *o*-anisidine and *o*-dianisidine, both of which are important bases for azo dye manufacture. The first base is prepared by a Béchamp-Brimmeyr reduction as was described for aniline (page 75). *o*-Dianisidine is prepared similarly to benzidine (see page 124), converting *o*-nitroanisole into the hydrazoanisole by dissolving in alcohol or solvent naphtha and treating with zinc dust and caustic soda, and then subjecting the hydrazoanisole to the "benzidine rearrangement."

The preparation of *o*-nitroanisole by the methylation of *o*-nitrophenol is described on page 148.

p-Nitrochlorobenzene-*o*-sulfonic Acid and *p*-Nitroaniline-*o*-sulfonic Acid from *p*-Nitrochlorobenzene

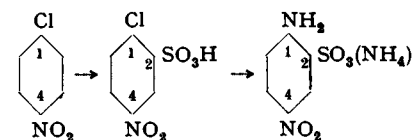

To a mixture (50°) of 100 grams of *p*-nitrochlorobenzene and 100 grams of 100 per cent sulfuric acid is added, with stirring, 280 grams of oleum (25 per cent SO₃). The mixture is heated at 100–110° until the nitrochlorobenzene has disappeared, then poured into 300 grams of ice and 300 grams of water and salted out with 200 grams of sodium chloride. After 24 hours, the product is filtered off and pressed out, yielding about 280 grams of moist filter cake. The conversion to *p*-nitroanilinesulfonic acid is accomplished by heating the broken up material with an equal weight of concentrated ammonia (20 per cent NH₃) in an autoclave at 150°C. for 8 hours. The pressure is about 6 atmospheres (steel tube manometer!). On cooling, the ammonium salt of the desired sulfonic acid separates in large, hard, ambercolored cubes. The isolated product weighs about 100 grams. In large scale operations, the mother liquor is worked up with chalk to recover the ammonia.

p-Nitroaniline-*o*-sulfonic acid is used particularly for the preparation of azo dyes; with β -naphthol, for example, it gives the useful dye, lake red P. Its reduction product, *p*-phenylenediaminesulfonic acid, is especially useful in the preparation of azine dyes; it is also used, in the form of its monobenzoyl derivative, in preparing azo dyes.

p-Nitrochlorobenzenesulfonic acid is finding increasing application in the preparation of diaminodiphenylaminesulfonic acid as well as aminodiphenylaminesulfonic acid. These preparations are shown in the following reactions.

1. Diaminodiphenylaminesulfonic Acid

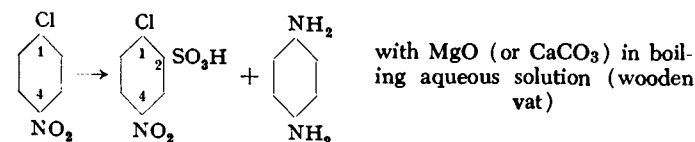

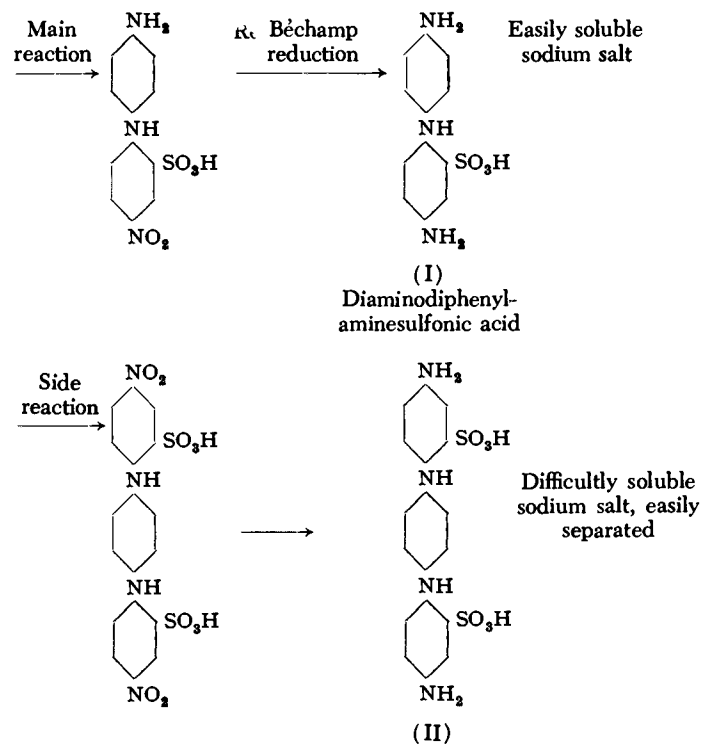

The intermediate (I), combined with aminonaphtholsulfonic acids, gives valuable dark cotton azo dyes.

2. Aminodiphenylaminesulfonic Acid (III), and Aminophenyl-tolylaminesulfonic Acid

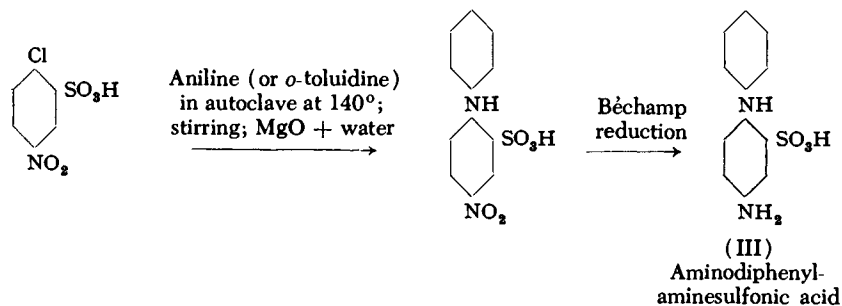

These components (III) are used in preparing the nerol dyes which are disazo dyes made by diazotizing (III) and coupling with α -naphthylamine, followed

by a second diazotization and coupling with Schaeffer salt or other coupling components.

It will be recalled that not only halogen atoms, but also nitro and sulfo groups, can be replaced by phenyl- or arylamines. The lability of the nitro group, particularly in the anthraquinone nucleus, permits the preparation of some important intermediates which cannot be discussed here. Also, highly nitrated benzene derivatives give access to interesting condensation products.

2,4-Dinitrochlorobenzene from Chlorobenzene

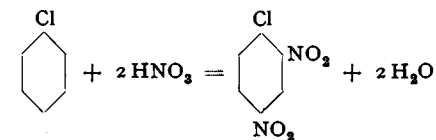
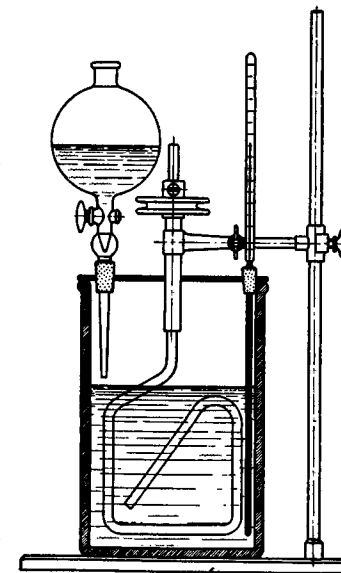

Fig. 19. Sulfonation and nitration vessel. The beaker is made of iron plate, or, better, cast iron (or porcelain or glass) and is about 11 cm. across and 20 cm. high. It is covered with a tightly fitting lead disk having openings for stirrer, thermometer, and addition tube. Stirrers of the type pictured have been found to be very practical. They can be made in the laboratory, preferably of iron, although glass rod can be used if the mechanical requirements are not too great. The bearing is best made of copper, since both iron and glass run well in copper and do not give rise to bothersome "freezing." The pulley is suitably made of bronze which also runs very well on copper (lubricant, petroleum jelly). The thermometer should have its scale near the top of the vessel. A dropping funnel with a dropping tip should be used whenever the introduction of the liquid must be watched carefully. The vessel is placed on a rigid tripod, and the stirrer bearing is secured rigidly with a strong clamp. The thermometer and the dropping funnel should also be secured, so that the stirrer can not hit the glass tubes inside the vessel.



In an iron nitrating vessel (Fig. 19) is placed 280 grams of mixed acid made from 140 grams of 100 per cent sulfuric acid and 140 grams of nitric acid (sp.gr., 1.52), and to this is added, dropwise and with good stirring, 113 grams (1.0 mole) of chlorobenzene, maintaining a temperature below 5°C. Stirring is continued at 5–10° for 1 hour after the addition is

completed, then the temperature is raised slowly to 50° and held there for another hour, after which 350 grams of concentrated sulfuric acid is carefully added dropwise to the vigorously stirred mixture. The mixture is then heated at 115° for 30 minutes, cooled, and poured into 2 liters of water whereupon it soon solidifies to a light yellow cake. This is separated from the mother liquor, and melted under water to remove all the acid, yielding a product almost chemically pure. The yield is 200 grams from 113 grams of chlorobenzene. The material melts at 51°. (A warning should be given about the unpleasant properties of dinitrochlorobenzene. Especially when in solution, it causes eczema and unbearable itching.)

Technical Observations. Dinitrochlorobenzene is manufactured on a very large scale, and is used in the preparation of sulfur black T (q.v.) and other important dyes. It is, moreover, the starting material for a whole series of condensation products made by replacing the very labile chlorine atom by basic and other residues. Thus, it is easy to prepare dinitroaniline and dinitrophenol, as well as picric acid and dinitroanisole, from dinitrochlorobenzene. The accompanying formulas show only a small part of the reactions actually used (also see Table V).

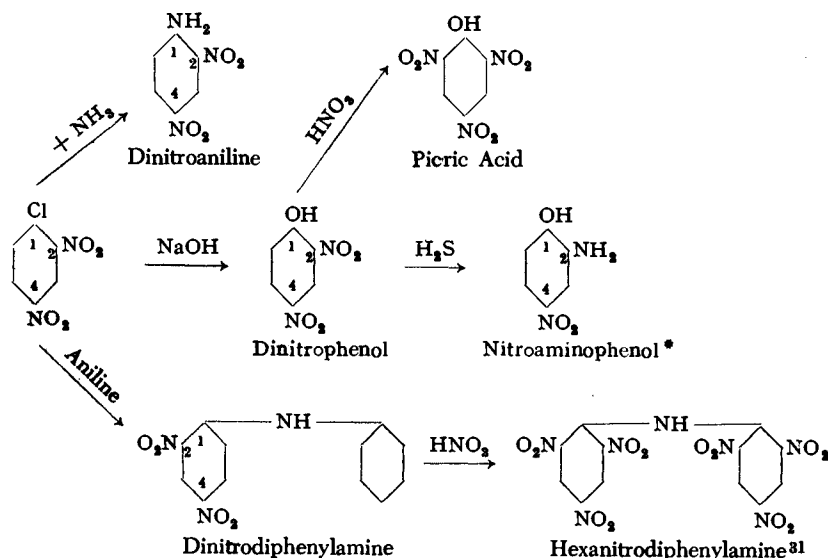

We have seen how smoother nitrations are obtained in the laboratory by using a 10 per cent excess of nitric acid. In plant processes, a much smaller excess is used and even this is recovered completely by separating the waste acid into its components, sulfuric and nitric acids. This is done with steam in denitrating towers.

* See page 115.

³¹ Carter, *Z. ges. Schliess- u. Sprengstoffw.*, 8, 205, 251 (1913).

m-Phenylenediaminesulfonic Acid from 2,4-Dinitrochlorobenzene³²

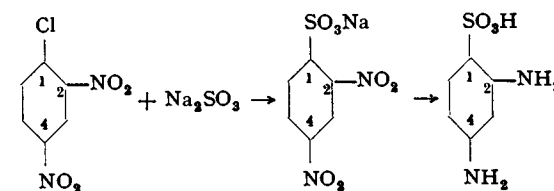

A solution is made of 202 grams (1.0 mole) of 2,4-dinitrochlorobenzene (page 101) in 500 cc. technical alcohol (not denatured with pyridine bases), exercising care that the solution does not come in contact with the skin (see page 102). To this solution is added the equivalent of 64 grams (1.0 mole) of SO₂ in the form of a saturated sodium sulfite solution. The sulfite solution is prepared from the calculated quantity of technical sodium bisulfite solution by the addition of concentrated sodium hydroxide solution. Enough sodium hydroxide is added to cause the disappearance of the yellowish color and give a faint red coloration with phenolphthalein paper. Some of the sulfite separates even from the hot solution, but this causes no difficulty. The mixture of dinitrochlorobenzene, sulfite, water, and alcohol is heated to boiling on the water bath for 5 hours with good stirring, then cooled as much as possible by placing in cold water. The sodium salt of dinitrobenzenesulfonic acid separates in lustrous yellow plates which are filtered off with suction and pressed out in a screw press. This product is reduced by exactly the same method used in the reduction of *m*-dinitrobenzene (see page 115). The solution of *m*-phenylenediaminesulfonic acid obtained in this way is not sufficiently pure for use in the preparation of azo dyes, however, and is purified by concentrating to about 400 cc. and adding 100 grams of salt. The solution is then acidified with hydrochloric acid causing the free sulfonic acid to crystallize out. It is important to use the correct amount of acid, since the sulfonic acid will redissolve in any excess acid. Congo red paper should not turn a distinct blue, but only a weak violet. After 2 days, the precipitate is filtered off and washed with a very small amount of water. The yield is 125 grams of pure material, or about 66 per cent of the theoretical amount.

Technical Observations. Reactions of this type are carried out most satisfactorily in lead lined iron kettles, and it is important that no other metal come in contact with the liquid. A few milligrams of copper or iron prevents the formation of even traces of the desired products. The dinitrobenzenesulfonic acid, as well as the final *m*-phenylenediaminesulfonic acid, is not filtered in a filter press, but is

³² Erdmann and Erdmann, *Ger. Pat.* 65,240 (1892) [*Frdl.*, 3, 41 (1890-1894)].

centrifuged. The residual alcohol is then removed in a hydraulic press. The alcohol is recovered by rectification and is used again. If care is exercised, the loss of alcohol in one operation does not exceed 5 per cent.

The preceding preparation is an example of the indirect introduction of the sulfo group, utilizing the lability of the chlorine in negatively substituted aromatic chlorine compounds (see also the following preparation).

m-Phenylenediaminesulfonic acid can also be prepared easily by sulfonation of pure *m*-phenylenediamine, dissolved in 100 per cent sulfuric acid, with oleum at 160°. It is used as a component in preparing azo dyes.

Aniline-2,5-disulfonic Acid from Chlorobenzene

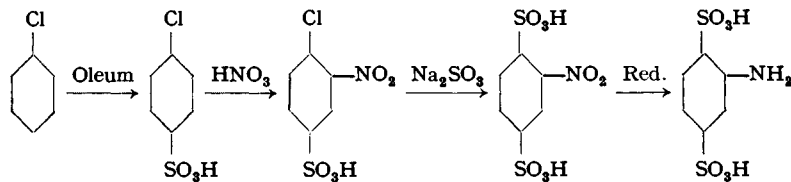

(a) 2-Nitrochlorobenzene-4-sulfonic Acid from Chlorobenzene³³

The reaction is carried out in a sulfonation kettle or a round-bottomed flask fitted with an efficient stirrer, thermometer, and dropping funnel, and surrounded by a larger container through which cold or hot water can be circulated (compare Figure 6, page 68, and Figure 20). 112.5 grams (1 mole) of chlorobenzene is added to a mixture of 220 grams of 100 per cent sulfuric acid and 125 grams of oleum (20 per cent SO₃) with stirring, over the course of about 30 minutes. The temperature rises to 70 or 80°C. When it begins to drop after the addition of the chlorobenzene has been completed, the surrounding water bath is heated to boiling and stirring is continued for about 2 hours, or until a test portion of the reaction mixture on dilution with water shows no oil droplets and has no odor of chlorobenzene when heated. (A completely clear solution is usually not obtained, because a very small amount of dichlorodiphenylsulfone is formed in the reaction. This does not separate as an oil on dilution, however, but as crystalline flocks.)

The reaction mixture is cooled in ice and 65 grams of nitric acid (sp.gr. 1.52) is added dropwise with stirring. The addition requires about 1.5 to 2 hours, and should be regulated so that the temperature of the reaction mixture remains between 15 and 20°. The cooling bath is

³³ Akt.-Ges. Anilin-Fab. Berlin, Ger. Pat. 116,759 (1900) [*Frdl.*, 5, 931 (1897-1900)].

removed and stirring is continued for 3 to 4 hours at room temperature. The nitrochlorobenzenesulfonic acid partially crystallizes, transforming the whole mixture to a stiff paste which must be broken up with a glass rod or a spatula to permit further stirring. When a nitrometer test shows

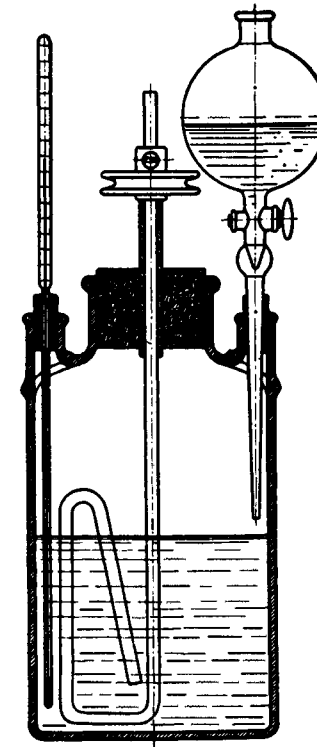

Fig. 20. Autogenously welded sulfonation vessel, especially for use with oleum.

that the residual nitric acid corresponds to the small excess used (about 2 grams), the reaction mixture is stirred with a cooled mixture of 1 liter of saturated salt solution and 500 cc. water. The precipitate is filtered off with suction and pressed out in a screw press (Fig. 21). The weight of moist filter cake is about 370 grams, consisting of about 72 per cent of solid material.

The sodium 2-nitrochlorobenzene-4-sulfonate can be obtained in a pure state by recrystallizing from hot water, dilute salt solution, or aqueous alcohol.

*(b) Nitrobenzene-2,5-disulfonic Acid*³⁴

The moist filter cake of sodium 2-nitrochlorobenzene-4-sulfonate (page 106) is dissolved in 400 cc. boiling water; the solution is filtered to remove any undissolved residue. To the filtrate is added 300 grams of crystalline neutral sodium sulfite ($\text{Na}_2\text{SO}_3 \cdot 7\text{H}_2\text{O}$), taking care that the resulting solution is not alkaline to phenolphthalein. (If it is, hydrochloric acid is added carefully just to the point of disappearance of the alkaline reaction.) The solution is now boiled under reflux for 2 hours, during which it becomes an intense yellow in color. The hot solution is then treated with 100 grams of solid salt, and when the latter is completely dissolved, the solution is allowed to stand overnight in the ice chest. The resulting thick paste is filtered with suction, and the filter cake is well pressed out and washed with cold saturated salt solution until the washings are only weakly yellow in color. Pure sodium nitrobenzene-2,5-disulfonate may be obtained by crystallization from aqueous alcohol, but the product obtained above is usable in the next reduction step without further purification.

(c) Aniline-2,5-disulfonic Acid

The reduction is carried out in the manner described for the preparation of aniline (page 75). The moist filter cake of nitrobenzene-2,5-disulfonic acid, obtained above, is added in small portions over the course of about 1 hour to a boiling, well stirred mixture of 200 grams of iron powder, 1 liter of water, and 20 cc. glacial acetic acid (Fig. 17, page 94). Stirring and boiling are continued for about 30 minutes, replacing the water lost by evaporation. The mixture is then made definitely alkaline with about 30 grams of soda ash and filtered hot to remove the iron sludge. The residue is boiled with a small amount of water and filtered, this process being repeated until the filtrate gives only a small amount of dye when it is diazotized and treated with an alkaline solution of β -naphthol or R salt. The combined filtrate and washings are made just acid to litmus by the addition of concentrated hydrochloric acid, and then evaporated to about 800 cc. 60 grams of solid salt is now added and the solution is made strongly acid by the addition of 200 cc. concentrated hydrochloric acid, after which it is cooled overnight. The colorless white paste is filtered with suction and the precipitate washed with saturated salt solution, pressed out, dried and pulverized. In this way is obtained about 210 to 220 grams of the monosodium salt of aniline-2,5-disulfonic acid in the form of a white powder. 1 gram of the product is equivalent

³⁴ Badische A. und S. F., Ger. Pat. 77,192 (1894) [*Frdl.*, 4, 37 (1894-1897)].

to about 3 cc. 1 N nitrite solution. The yield is about 65 per cent of the theoretical amount based on chlorobenzene.

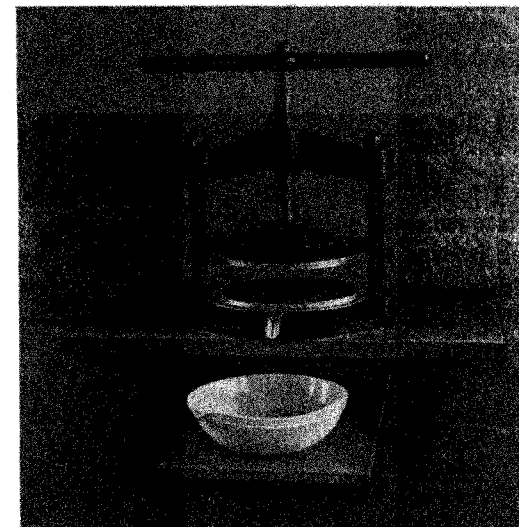

Fig. 21. Screw press with wrought iron frame. The press plate is covered with copper plate; the product is placed between small hardwood boards.

2-Nitrochlorobenzene-4-sulfonic acid can be prepared also by sulfonation of *o*-nitrochlorobenzene (see Table III). This method, however, is inherently more costly and less reliable than the one given above (nitration of chlorobenzene-4-sulfonic acid), because it requires the isolation of *o*-nitrochlorobenzene and its separation from the para isomer. Nevertheless, the second method may be preferable technically under those circumstances where the demand for *p*-nitrochlorobenzene is so large that a use for the by-product ortho isomer is needed. At the present time, the situation is reversed. The manufacture of *o*-nitroanisole uses so much *o*-nitrochlorobenzene that the accumulated para compound is partly used in making *p*-nitroaniline.

Reduction of 2-nitrochlorobenzene-4-sulfonic acid gives *o*-chlorometanilic acid which is used in making azo dyes. The real technical value of nitrochlorobenzene-sulfonic acid, however, lies in the ability of its chlorine atom to be replaced by various groups. For example, *o*-nitrophenol-*p*-sulfonic acid is obtained by treatment with sodium hydroxide, and this product, on reduction, yields *o*-aminophenol-*p*-sulfonic acid. Analogously, nitrochlorobenzene-sulfonic acid gives *o*-nitroanisole-*p*-sulfonic acid by treatment with alcoholic methanol, and from this is obtained *o*-anisidine-*p*-sulfonic acid. The action of ammonia on nitrochlorobenzene-sulfonic acid produces *o*-nitroaniline-*p*-sulfonic acid; aniline and its derivatives produce *o*-nitrodiphenylamine-*p*-sulfonic acids (cf. Table II).

Another replacement reaction of this same type is the reaction with neutral sulfite, whereby the chlorine is replaced by a sulfo group, leading to nitrobenzene-2,5-disulfonic acid which can not be obtained by direct sulfonation.

Aniline-2,5-disulfonic acid, the preparation of which is described above, is used as a starting material for azo dyes, especially disazo and trisazo dyes of the type of Sirius light blue (see page 279).

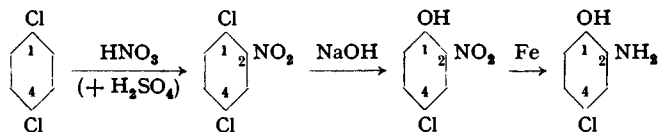
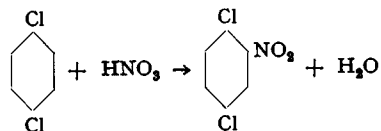
4-Chloro-2-aminophenol from *p*-Dichlorobenzene(a) Nitro-*p*-dichlorobenzene from *p*-Dichlorobenzene

In a three-necked flask equipped with stirrer, thermometer, and dropping funnel, 147 grams (1.0 mole) of coarsely pulverized *p*-dichlorobenzene (by-product of benzene chlorination, page 65) is covered with 300 grams of 100 per cent sulfuric acid. To this mixture is added with good stirring, over the course of 1 to 1.5 hours, a mixture of 68 grams of nitric acid (sp.gr. 1.52) and 68 grams of 100 per cent sulfuric acid. (The acid mixture is prepared by slowly adding the sulfuric acid to the nitric acid with cooling.) When the temperature reaches 30°C. the reaction flask is cooled slightly with water and the addition of acid is regulated so that the temperature remains between 30 and 35°. The crystals of *p*-dichlorobenzene gradually melt and when about half of the nitrating mixture has been added, an almost clear, oily layer is formed (eutectic mixture of *p*-dichlorobenzene and its nitro derivative). Vigorous stirring is necessary to achieve satisfactory mixing. Later, the nitro-*p*-dichlorobenzene begins to crystallize out. This may occur suddenly with the liberation of considerable heat, especially if the stirring has been inadequate, and hence this phase of the reaction should be watched carefully. If a rapid rise in temperature is observed, the addition of the nitrating mixture is interrupted and the cooling is increased in order to keep the temperature below 50° at the most. When the addition of the acids is completed, the reaction mixture is a thick, pale yellow, crystalline mass. Stirring is continued for 3 or 4 hours, or until a nitrometer test shows that the residual nitric acid corresponds to the excess used. The end of the reaction can also be determined by diluting a test sample of the reaction mixture with water, filtering off the solid and determining its melting point (56–57°). A mixture of 700 grams of ice and 300 cc. water is now added, and the precipitated material is filtered off with suction and washed with cold water. In order to remove the last traces

of acids, the product is melted under 500 cc. hot water, stirred well, and allowed to cool to form a compact cake. This operation is repeated once more, and the acid-free, light yellow, crystalline material is then dried on filter paper at room temperature. The yield of product melting at 56–57° is 186 to 188 grams, or 97 to 98 per cent of the theoretical amount.

Remarks. Nitro-*p*-dichlorobenzene can be reduced to *p*-dichloroaniline in the usual way with iron and a small amount of acid. The chlorine ortho to the nitro group is labile and can be replaced by various substituents, less easily, however, than the chlorine in 2,4-dinitrochlorobenzene, but more easily than that in *o*-nitrochlorobenzene. The replacement of the chlorine by hydroxyl by the action of aqueous sodium hydroxide is described in the following preparation. Reaction with sodium methylate yields 4-chloro-2-nitroanisole, which is reduced to 4-chloro-2-anisidine (chloranisidine P, or fast red R base). With ammonia under pressure, 4-chloro-2-nitroaniline (fast red 3GL base) is formed. These bases are important starting materials for the preparation of azo dyes, especially pigment and lake colors, as well as ice colors.

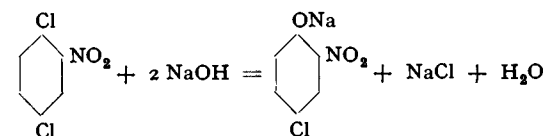
(b) 4-Chloro-2-nitrophenol from Nitro-*p*-dichlorobenzene

A mixture of 48 grams (0.25 mole) of nitro-*p*-dichlorobenzene, 86 grams (0.75 mole, 50 per cent excess) of sodium hydroxide solution (40° Bé), and 600 cc. water is placed in an autoclave, equipped with stirrer, and heated with good stirring for about 15 hours at 145°C. (internal temperature; oil bath, 186–190°). The pressure remains below 3 atmospheres. After cooling, the autoclave contents consist of a paste of well-formed red crystals of the difficultly soluble sodium salt of *p*-chloro-*o*-nitrophenol. These crystals are separated by filtration, washed with dilute salt solution and then dissolved in about 500 cc. of boiling water. The solution is filtered to remove traces of undissolved material, then strongly acidified with concentrated hydrochloric acid. After thoroughly cooling the mixture, the coarsely crystalline precipitate of free chloronitrophenol is filtered off, washed with cold water, and dried on filter paper at room temperature. If the reaction has been carried out properly, this product is light yellow in color and has the correct melting point of 87–88°. It can be used in the following reduction step without further purification. The original alkaline filtrate gives, on acidification, a few grams more of less pure product which can be purified by steam dis-

tillation. The total yield of product is about 37 grams, or 85 per cent of the theoretical amount.

To achieve good results in this preparation, it is absolutely essential: (1) to maintain as rapid stirring as possible in the autoclave, with the stirrer reaching to the bottom (the rotating autoclave described on page 359 is not suitable for this preparation), (2) to maintain the prescribed temperature exactly, and (3) to use sodium hydroxide that is no more concentrated than described. If the alkali is too concentrated or the temperature too high, resinification occurs and the yield is appreciably lowered.

(c) *4-Chloro-2-aminophenol from 4-Chloro-2-nitrophenol*

Since *p*-chloro-*o*-nitrophenol is easily volatile with steam, the reaction vessel must be provided with a tight cover and a reflux condenser (cf. Fig. 11). It is recommended that a very weak vacuum be applied to the end of the reflux condenser so that vapor does not escape from the opening when additions are made, but air is drawn in through it. In spite of this precaution, some of the chloronitrophenol, if it is finely powdered, melts on the spoon, and it is desirable, therefore, to have it in lumps the size of peas. These may be prepared by melting the material in a porcelain dish on a water bath, then allowing it to solidify as a cake which is then broken up. In large scale operations, the nitro compound is introduced as a liquid from a heated container.

The reduction kettle is charged with 50 grams of finely powdered cast iron shavings (see page 77), 200 cc. water, and 25 cc. 2 *N* hydrochloric acid, and the mixture is heated in a boiling water bath. While stirring vigorously, 34.7 grams (0.2 mole) of 4-chloro-2-nitrophenol is added over a period of 1 to 1.5 hours. Stirring and heating are continued for at least 30 minutes more, after which the chloronitrobenzene which has condensed in the condenser and on the cover and stirrer is washed down into the reaction mixture. The reduction is complete when no more chloronitrobenzene distills into the condenser and its odor has disappeared. Also, a few drops of the reaction mixture on filter paper should be almost colorless and not turned yellow by treatment with sodium hydroxide. The reaction vessel is now opened and 25 cc. 2 *N* soda solution is added very carefully with stirring to precipitate the dissolved iron, then 25 cc. sodium hydroxide solution (40° Bé) to dissolve the chloroaminophenol.

The iron sludge is filtered off hot and washed carefully with hot water until an acidified test portion of the washings is colored only slightly yellow on addition of nitrite solution. The filtrate, while still warm, is treated with enough concentrated hydrochloric acid (about 25–28 cc.) to produce a faint acid reaction to litmus, and then the small excess of acid is neutralized by adding a few drops of concentrated sodium acetate solution. Precipitation of glittering plates begins even in the warm solution, and increases on cooling. The precipitation is com-

pleted by adding salt, and allowing the mixture to stand overnight. The solid material is filtered off with suction, washed first with 15 per cent salt solution, then with water, and dried in a steam heated drying oven. The yield is about 26 grams, or 90 per cent of the theoretical amount.

If the reduction has been carried out properly using the pure nitro compound, the product is very light gray in color and melts within a few degrees of the melting point of pure 4-chloro-2-aminophenol (140–141°). It can generally be used without further purification for the preparation of azo dyes. If necessary, the product can be made completely pure by recrystallizing from hot water or by dissolving in hot, dilute hydrochloric acid, filtering, and exactly neutralizing with carbonate solution.

Remarks. The reduction can be effected also with sodium sulfide by the same method given for aminophenoldisulfonic acid (page 153). Isolation of the product is accomplished by neutralizing (with soda) the acid solution which has been filtered to remove sulfur.

4-Chloro-2-aminophenol is used chiefly for the preparation of blue azo dyes which can be after-chromed. Its combinations with chromotropic acid and with acetyl-H acid were the purest chrome blues known before the discovery of the chroming triphenylmethane dyes (eriochrome azurol). The latter dyes are superior in depth and brilliance of color, but are not as fast to light as the azo dyes from 4-chloro-2-aminophenol and chromotropic acid or acetyl-H acid.

7. Derivatives of Nitrobenzene

m-Dinitrobenzene from Nitrobenzene

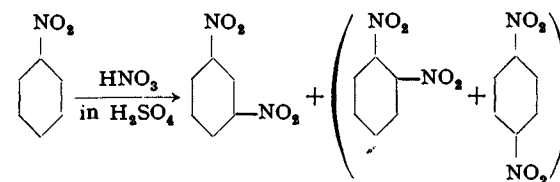

In an iron or glass nitrating vessel equipped with stirrer and thermometer, 70 grams of anhydrous nitric acid (density 1.52), or the equivalent quantity of at least 85 per cent acid, is added with good external cooling to 500 grams of 100 per cent sulfuric acid. To the well stirred acid mixture (which can be replaced by the corresponding quantity of a 30 per cent mixed acid) is added, during the course of 30 minutes, 123 grams of *dry, pure* nitrobenzene. The reaction vessel is cooled with ice and care is taken that the temperature does not exceed 15–20°C. After all of the nitrobenzene has been added, stirring is continued for 1 hour at room temperature, and then the mixture is warmed to about 35° to redissolve the dinitrobenzene which has separated, and is poured with thorough stirring onto 1 kilogram of ice. The precipitated dinitrobenzene is filtered off and washed with cold water. This crude product is

melted with two 400-cc. portions of water, the first being made distinctly alkaline to litmus by the addition of carbonate.

The dinitrobenzene obtained in this way contains appreciable amounts of the 1,2 and 1,4 isomers which can be removed easily, since both of these isomers, in aqueous emulsion, react with sodium sulfite and are transformed into the easily soluble nitrobenzenesulfonic acids, whereas the 1,3 isomer is not attacked appreciably under these conditions.

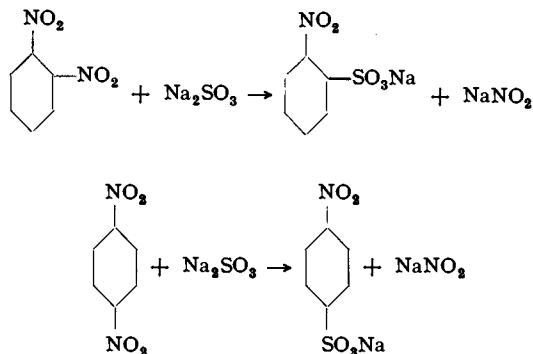

To effect this purification, the crude product is melted in 500 cc. water at about 80°C., and 5 grams of a wetting agent is added (soap, Turkey red oil, Igepon T, Nekal BX, etc.). To the well stirred oily suspension is added, over a period of 30 minutes, 20 grams of crystalline sodium sulfite, and stirring is continued for 2 hours more at 90 to 95°. The mixture becomes dark brown in color as the undesired isomers go into solution. The mixture is allowed to cool to room temperature while stirring is continued, and then the solid precipitate is separated from the mother liquor by filtration. The precipitate is remelted under 500 cc. water and again cooled while stirring. The *m*-dinitrobenzene, obtained as almost white, small crystals, is dried below 90°. The yield of pure *m*-dinitrobenzene melting at 90.7°–91.4° (freezing point 90.5–91°) is 140 to 150 grams, or 83 to 90 per cent of the theoretical amount.

Remarks. Dinitrobenzene is strongly poisonous, and therefore the vessels used in remelting and purifying the product should be covered. *Alcoholic solutions*, especially, can cause cyanosis and protracted eczema. All three isomers are appreciably soluble in water.

Nitration of nitrobenzene always yields, in addition to the *m*-dinitrobenzene, some (5 to 15 per cent) of the ortho and para isomers, the quantity of these being larger the higher the temperature.³⁵ It is essential that these isomers be removed in order to obtain, by reduction, *m*-phenylenediamine which gives good

³⁵ O. Wyler, *Helv. Chim. Acta*, 15, 23 (1932).

yields of dyes. *m*-Phenylenediamine, once prepared, can be separated from its isomers only with difficulty, and only a small amount of *o*- or *p*-phenylenediamine in the meta compound is enough to reduce its stability. In addition, the ortho and para isomers, because of their strong reducing action, cause decomposition of diazonium compounds. Hence, if impure *m*-phenylenediamine is used as a component for azo dyes, persistent foaming is encountered in the coupling reaction because of the generation of nitrogen, and the decomposition products of the diazonium compound contaminate the dye and the yield is decreased (see pages 288 and 292).

m-Dinitrobenzene is used mainly for the preparation of *m*-nitroaniline and *m*-phenylenediamine.

m-Nitroaniline from *m*-Dinitrobenzene

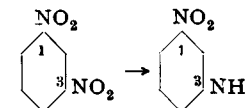

A solution of 110 grams of crystalline sodium sulfide (Na₂S · 9H₂O) in 80 cc. water is treated with hydrogen sulfide until the solution is completely saturated. In this way a clear solution of sodium hydrosulfide (NaSH) is obtained. In a 2-liter glass or iron beaker, another solution is prepared containing 4 grams of Nekal BX (or some other effective emulsifying agent) and 10 grams of ammonium chloride in 420 cc. hot water, and to this solution is added, at 90°C., 84 grams (0.5 mole) of pure *m*-dinitrobenzene, stirring the mixture vigorously enough to produce a fine emulsion (care! very poisonous vapors). The temperature is allowed to fall to 85° and then, with continued vigorous stirring, the previously prepared hydrosulfide solution is added, during the course of 15 minutes, maintaining the temperature between 80 and 85°. Since heat is given off by the reaction, the flame must be reduced or occasionally removed altogether. When the addition has been completed, stirring is continued for 5 minutes without further heating and then the mixture is cooled to 20° by the addition of ice. Stirring is continued for about 1 hour more at room temperature, and then the *m*-nitroaniline, which has separated in yellow crystals, is filtered with suction and washed with cold water. The moist filter cake is mixed with 250 cc. water and 80 cc. concentrated hydrochloric acid (technical) and the mixture is boiled until all of the *m*-nitroaniline has dissolved. The solution is then cooled, causing any residual *m*-dinitrobenzene, which is quite soluble in hot water, to separate. The solution is filtered to remove undissolved material (chiefly dinitroazoxybenzene), heated, and treated with sufficient ammonia to produce a strongly alkaline reaction. After cooling the solution, the puri-

fied *m*-nitroaniline is filtered off, washed with water, and dried. The yield of the product melting at 110–112° is 62 grams. This material is sufficiently pure for most purposes. It can be made chemically pure by recrystallization from about 4 liters of boiling water, thus removing a very small amount of tarry residue. The recrystallized *m*-nitroaniline forms golden yellow needles melting at 114°.

The crude product can also be recrystallized from water directly, without previously remelting. If it contains unchanged *m*-dinitrobenzene, however, some of this impurity will crystallize out with the main product.

Partial Reductions in General

The common reduction methods, using iron in acid or almost neutral solution, are not usable for selectively reducing one of several nitro groups present in a molecule. This is true also for those cases where some other easily reducible group, such as the azo group, is present along with the nitro group (see page 289). Iron attacks all the reducible groups simultaneously. For these "partial reductions," sodium sulfide or some other sulfide is generally used technically. In many cases, even these reducing agents must be used with care, in order to restrict the reduction, adding the reagent gradually, avoiding an excess of it, and operating at the lowest temperature at which the reaction will proceed. The optimum temperature differs with individual cases; it may vary from 0° to 100°C. and must be determined, by tests, along with the other reaction conditions, in each instance. The reactions are usually carried out in water solution or, if necessary, in aqueous alcoholic solution.

With dinitro compounds in which the nitro groups are in the 2 and 4 positions relative to an alkyl, hydroxyl, alkoxy, or amino group, partial reduction usually leads to reduction of the 2-nitro group.

The sodium sulfide is converted in the reaction *mainly* into sodium thiosulfate according to the reaction:

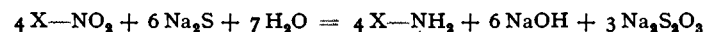

Hence, about 1.5 moles of Na₂S is needed for each nitro group to be reduced. (The reduction does not always follow *exactly* the reaction given. Hence, the optimum quantity of sodium sulfide may vary somewhat from the theoretical amount and must be determined by trial.) Frequently, the hydroxide formed in the reaction has a deleterious effect, and in this event better results are obtained with sodium hydrosulfide (NaSH), i.e., a solution of sodium sulfide saturated with hydrogen sulfide. The reaction then proceeds without forming hydroxide, according to the equation:

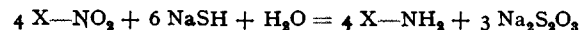

If the substance being reduced contains an acid group, this may serve to neutralize the alkali formed (see, e.g., the preparation of picramic acid, page 152). It may also be beneficial to add MgSO₄ to the reduction mixture. Since this compound reacts with the NaOH formed to precipitate very slightly soluble Mg(OH)₂, the solution can become only weakly alkaline.

Certain nitro compounds must be reduced in ammoniacal solution with exactly the calculated amount of hydrogen sulfide. Thus, dinitrophenol can be reduced successfully to nitroaminophenol only by treating the very finely divided sodium salt, directly as it is obtained by the hydrolysis of dinitrochlorobenzene, with exactly the calculated quantity of hydrogen sulfide at about 60° (see sulfur black T). The nitroaminophenol obtained in this way is best recrystallized from boiling water. The difficultly soluble diazonium compound from nitroaminophenol coupled with *m*-phenylenediaminesulfonic acid (page 103) gives the cheapest chrome brown for wool. The coupling reaction is carried out in neutral solution, as concentrated as possible, for 2 to 3 days at 28°.

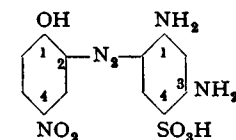

Chrome brown R (Kalle)

m-Phenylenediamine from *m*-Dinitrobenzene

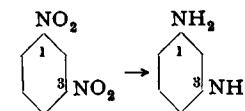

In the reduction vessel (cf. page 75 and Fig. 17) are placed 1500 cc. water and 400 grams of fine iron shavings (page 75). The iron is etched with 20 cc. concentrated hydrochloric acid by boiling the mixture for at least 5 minutes. Then, with continuous stirring, 168 grams of pure dinitrobenzene is added in portions of not more than 2 grams each. The reaction mixture first turns yellow, due to the formation of *m*-nitroaniline, and each addition causes foaming which is often so violent that water must be squirted onto the surface of the reaction mixture. For satisfactory reduction, the temperature should be kept at the boiling point, and each new addition of dinitrobenzene must be delayed until a drop of the reaction mixture on filter paper is colorless. If the additions are made too rapidly, the mixture become brown due to the formation of azoxy compounds. If this happens, the reduction is unsuccessful and should be discontinued. The trouble may also arise from a bad batch of iron, emphasizing the need for testing each iron sample for its reactivity before purchasing it. Ordinarily, however, the dinitrobenzene can be reduced satisfactorily in 40 minutes, yielding a solution which is light brown in color, or often almost colorless and turning dark rapidly. Boiling is continued for at least 5 minutes, replacing the evaporated water

so as to maintain the original volume of about 2 liters. This solution contains about 45 grams of diamine per liter.

About 10 grams of solid soda ash is now added in small portions to the boiling solution to make it distinctly alkaline to litmus, and boiling is continued for 5 minutes to decompose the soluble iron complex of the hydroxylamine which is present. This boiling is continued until a test drop on filter paper gives no dark flecks when treated with sodium sulfide solution (1:10). The sodium sulfide test should not be omitted even in large scale reactions, since it can save much trouble. (If the test for iron does not disappear even after prolonged boiling, the residual iron is precipitated with a small amount of ammonium sulfide.) The solution is then filtered into a warm flask, and the filtrate is treated with the amount of hydrochloric acid necessary to produce a weakly acid reaction to litmus. The *m*-phenylenediamine solution prepared in this way is quite stable. The yield is about 95 grams. The solution can be analyzed with diazotized aniline in very dilute solution at 0°, or analogously with H acid except that no soda is added (see Analytical Section).

The technical solution obtained above is sufficiently pure for many purposes, but generally a purer product is desirable since it gives better yields of dyes. Purification is accomplished by evaporating the solution (not acidified), first over a free flame, then in vacuo, until the residue contains 40 per cent of the base. This concentrated solution can be completely evaporated in vacuum and the base distilled or, better, the base may be frozen out of the 40 per cent solution at 0°. In order to induce crystallization in this "cold process," the solution must be seeded with a crystal of the phenylenediamine. The pure diamine crystallizes out in beautiful white prisms, containing one-half molecule of water of crystallization, which are completely stable, in contrast to the crystals of an impure product.

The homologous 1,2,4-toluylenediamine is prepared in the same manner as *m*-phenylenediamine. The procedure given above is applicable to the reduction of 2,4-dinitrochlorobenzene, 2,4-dinitroanisole, *p*-nitroanisole, and other insoluble nitro compounds.

m-Chloronitrobenzene from Nitrobenzene

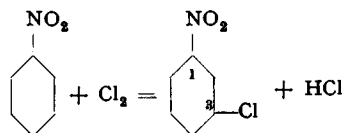

Chlorination of nitrobenzene in the laboratory requires very careful operation and succeeds only if the reaction is carried out in the complete absence of moisture. Even traces of water prevent the chlorination or retard it excessively. It is essential, therefore, that the apparatus and the starting materials be dried thoroughly.

Anhydrous ferric chloride is the most satisfactory chlorine carrier. The commercial material is heated under reduced pressure in a round-bottomed flask through which a gentle stream of dry chlorine or hydrogen chloride is drawn. When the material begins to sublime, it is transferred to a bottle with a tight glass stopper.

The nitrobenzene is dried by heating for several hours in a round-bottomed flask at 80–100°C. while a stream of dry air is drawn through it by means of a wide capillary tube.

The same apparatus recommended for the preparation of chlorobenzene (page 63, cf. Fig. 5) may be used for chlorinating a batch of 246 grams of nitrobenzene. The reflux condenser is not necessary, however, since nitrobenzene has a considerably higher boiling point than benzene. The reaction vessel should be arranged so that it can be heated easily, preferably in a water bath, and also cooled if necessary. The hydrogen chloride generated is passed through a calcium chloride drying tower and then absorbed as in the chlorobenzene preparation.

5 grams of the prepared ferric chloride suffices as the carrier. The reaction temperature should be kept *between 40 and 45°C.*; larger amounts of by-products are formed at higher temperatures. The rate of chlorine absorption is much lower than in the chlorination of benzene, at least 6 hours being required for the completion of the reaction. The progress of the reaction is followed by weighing the reaction flask, and the chlorination is continued until the weight has increased 85 grams. Because of the appreciable solubility of chlorine and hydrogen chloride in the reaction mixture, this weight increase corresponds to about 2 moles of chlorine actually reacted.

The chlorine stream is interrupted, and the reaction mixture is allowed to stand for a short time, then it is poured into a separatory funnel and washed thoroughly with hydrochloric acid, soda solution, and water. If part of the mixture has not already precipitated as a white crystalline solid, the mixture is transferred to a beaker until part of it solidifies, then it is filtered, cooled to about 10°, and centrifuged. About 95 grams of practically pure *m*-nitrochlorobenzene is obtained. The filtrate and the liquid from the centrifuge are combined and subjected to fractional distillation in vacuo. For this purpose, a column should be used which is about 80 cm. in length and provided with a partial condenser. Approximately the following fractions are collected:

(1) About 40 grams of liquid boiling at 85–106° at 9 mm. This fraction consists of nitrobenzene and some chloronitrobenzene.

(2) About 130 grams of solidifying material, boiling at 106–108° at 9 mm. This material gives on cooling and centrifuging about 100 grams of pure *m*-chloronitrobenzene. The liquid residue from the centrifuge yields only traces of chloronitrobenzene on redistillation and consists largely of a mixture of by-products (3,6-dichloronitrobenzene, *p*-chloronitrobenzene, *o*-chloronitrobenzene, etc.).

(3) Material boiling higher than 108°, and the residue. This fraction consists of the by-products mentioned. Sometimes so much hexachlorobenzene is present that it separates after long standing.

The yield of *m*-chloronitrobenzene is about 60 per cent, or 75 per cent allowing for the recovered nitrobenzene. The pure product boils at 107° at 9 mm. and melts at 44.5°C.

2-Chloro-4-dimethylaminobenzaldehyde

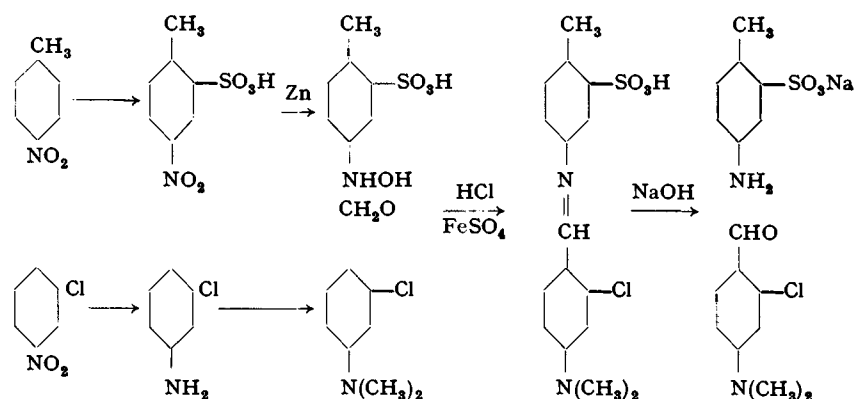
(a) *p*-Tolyhydroxylaminesulfonic Acid

A solution of 47.8 grams (0.2 mole) of 100 per cent sodium *p*-nitrotoluene-*o*-sulfonate (prepared from *p*-nitrotoluene exactly like *m*-nitrobenzenesulfonic acid is made from nitrobenzene; see page 120) and 8 grams of ammonium chloride in 200 cc. hot water is exactly neutralized with ammonia. The solution is placed in an iron reduction beaker and cooled to 25°C. with stirring. The air is swept out with a stream of carbon dioxide, and then 40 grams of zinc dust is added over the course of 3 to 4 minutes through a coarse nozzle. The zinc dust must be finely distributed throughout the reaction mixture. During the reduction, the mixture must be stirred vigorously and cooled externally with ice. The reaction starts abruptly and the temperature rises rapidly as shown by the following example:

Time, min.	0	1	2	3	4	5	6	7	8	9
Temperature, °C.	25	26	38	46	40	32	28	22	18	15

The mixture is filtered at once, and the zinc is washed with four 20-cc. portions of water. The filtrate and washings are combined in a graduated cylinder, the total volume measuring 240 cc.

A 2-cc. sample of the solution is taken for determining the content of *p*-tolyhydroxylaminesulfonic acid by means of Fehling solution. The test sample is diluted to 50 cc. and treated with 30 cc. Fehling solution [prepared by mixing equal parts of Solution I and Solution II: (I) 69.278 grams of chemically pure crystalline copper sulfate in 1 liter of solution; (II) 346 grams of Rochelle salt and 130 grams of sodium hydroxide in water to make up 1 liter]. The mixture is heated to boiling over a hot

flame and boiled *exactly* 2 minutes, then cooled by immersing in cold water. The cuprous oxide is filtered off through a fritted glass filter crucible and washed with two 25-cc. portions of water. The filtrate is poured out and the suction flask is rinsed out well, and then the cuprous oxide is dissolved in an excess of sulfuric acid-ferric sulfate solution (50 grams of ferric sulfate and 200 grams of concentrated sulfuric acid dissolved in water to make 1 liter). The cuprous oxide dissolves according to the equation:



The solution is sucked through the crucible, the latter is washed with water, and the ferrous salt determined with 0.1 *N* potassium permanganate solution.

The oxidation with Fehling solution does not take place stoichiometrically. The hydroxylamine corresponding to the permanganate used is read from the curve (Fig. 22), and from this the yield is determined. Suppose, for example, that 7.9 cc. 0.1 *N* KMnO_4 were used. This corresponds to 11.1 cc. 0.1 *N* hydroxylaminesulfonic acid.

$$\frac{120 \times 11.1}{10,000} = 0.133 \text{ mole hydroxylaminesulfonic acid}$$

The yield is therefore 66.5 per cent, and 0.125 mole of *p*-tolyhydroxylaminesulfonic acid is contained in 225 cc. of the solution.

(b) 2-Chloro-4-dimethylaminobenzaldehyde

15.6 grams (0.1 mole) of *m*-chlorodimethylaniline* is dissolved in 40 cc. concentrated hydrochloric acid, and after cooling, 7.7 cc. 39 per cent formaldehyde is added. This mixture is poured into the well stirred solution of 0.125 mole of *p*-tolyhydroxylaminesulfonic acid, i.e., 225 cc. of the solution prepared above. Then, 70 cc. of a 20 per cent ferrous sulfate solution is added immediately. The reaction mixture warms up to about 40°C., and after a few minutes crystals begin to separate, the whole mixture soon becoming a thick paste which is made more easily filterable by stirring. After 12 hours, the benzylidene compound is filtered off with suction and washed with 20 per cent salt solution. The filtrate is made alkaline with sodium hydroxide and steam distilled to recover 3.6 grams of chlorodimethylaniline.

* Obtained from *m*-chloroaniline by the procedure given for dimethylaniline, page 133. *m*-Chloroaniline is prepared from *m*-nitrochlorobenzene, page 116, exactly as aniline is prepared from nitrobenzene, page 75. *m*-Chloroaniline is very poisonous.

For the hydrolysis, the benzylidene compound is dissolved in 300 cc of a warm 2 per cent soda ash solution, and the solution is filtered to remove a residue of iron carbonate. The solution is then treated with 5 cc. concentrated sodium hydroxide solution (40° Bé) and heated with stirring for 1 hour on a water bath. The solution becomes cloudy and the aldehyde separates in oily drops which solidify on cooling. It is dissolved in 1:1 hydrochloric acid and reprecipitated with 2 *N* soda solution. The yield is 13.2 grams of dry aldehyde melting at 81° (72 per cent calculated on the base used, or 94 per cent calculated on the unrecovered base). The aldehyde can be recrystallized from ligroin. It is used, for example, in the preparation of wool blue 5B (see page 305).

m-Nitrobenzenesulfonic Acid and Metanilic Acid from Nitrobenzene

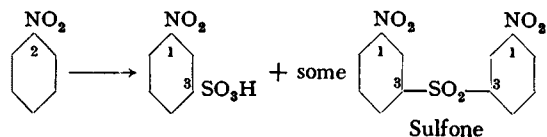

In a cast iron kettle, 123 grams (1.0 mole) of nitrobenzene is added carefully at 70°C. to a threefold quantity of oleum containing 25 per cent SO_3 . The mixture heats up rapidly to 100–110° but should not be allowed to go higher or sudden charring may occur. When the addition of nitrobenzene is completed, the mixture is heated at 110–115° until a test sample in water has no trace of nitrobenzene odor. If the sulfonation is not complete in 30 minutes after the mixing, the SO_3 is insufficient and 50 grams more of oleum is added dropwise. If necessary, another 50-gram portion is added after another half-hour. If the oleum actually contains 25 per cent of SO_3 , however, these additional quantities should not be necessary. When the sulfonation is completed, the reaction mixture is cooled and poured onto 500 grams of ice with good mechanical stirring. The nitrobenzenesulfonic acid goes into solution, leaving a small amount of sulfone undissolved.

The acid can be worked up by various methods, such as, for example, that given for benzenesulfonic acid on page 80 ff. It is preferable, however, to salt out the sulfonic acid since its sodium salt is practically insoluble in saturated salt solution. With continuous mechanical stirring, 200 grams of salt is added in small portions. Sodium nitrobenzenesulfonate separates, forming a thick paste which gradually becomes more fluid on long continued stirring. After about 10 hours, the solid is filtered off on a large suction funnel and pressed out for several hours in a cotton

cloth in the screw press. The sodium salt is usable technically without further purification. It can be obtained pure by recrystallizing from water.

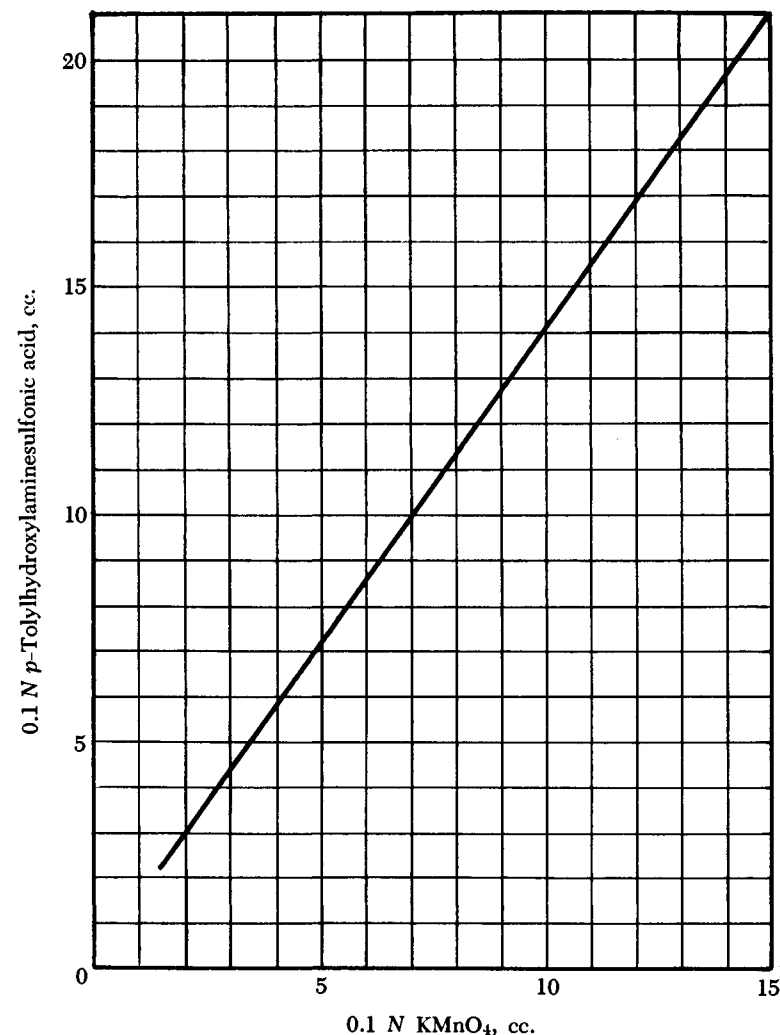

Fig. 22. Curve for determination of *p*-tolyldihydroxyaminesulfonic acid.

The reduction of *m*-nitrobenzenesulfonic acid is carried out by the method given for preparing aniline (page 75), except that the iron need not be etched since the free mineral acid in the press cake is sufficient to start the reaction. In an iron or copper reduction beaker of about 2-liter capacity are placed 250 grams of finely pulverized cast iron and 1 liter of water. This mixture is heated to boiling

over a free flame and then, with brisk stirring and continued heating, the broken-up press cake is added in small portions during the course of 1 hour. The evaporated water is replaced from time to time so that the volume is held at about 1 liter. Boiling is continued for another 20 minutes and a spot test on filter paper is made to determine whether the solution is nearly colorless; it should be only very light brown in color, never dark brown or deep yellow. If the solution is decolorized, soda ash is added, very carefully to avoid foaming over, until the solution is strongly alkaline to litmus and a spot test on filter paper gives no blackening with sodium sulfide solution. The iron sludge is then filtered off with suction and washed well with hot water. By evaporating the filtrate to 600 cc. and making it acid to Congo red with hydrochloric acid, the metanilic acid is precipitated in the form of fine crystals. Many plants prefer to use the concentrated solution directly, since metanilic acid is quite soluble and its separation always entails a 10 to 15 per cent loss. This loss is offset, however, by higher dye yields. The yield is determined simply by titrating the mineral acid solution with sodium nitrite; it amounts to about 90 per cent, or 155 grams of the pure acid.

Remarks. Ferrous sulfate can be used advantageously instead of salt to precipitate the *m*-nitrobenzenesulfonic acid. The iron salt is very difficultly soluble in 20 per cent sulfuric acid and can be filtered off directly without further treatment. The reduction is carried out exactly as described above. If benzene is sulfonated with 100 per cent sulfuric acid, and then the benzenesulfonic acid is nitrated at 100°, there are formed, according to the work of Obermiller,³⁶ besides the meta sulfonic acid, considerable quantities of the ortho and para isomers. The latter can be separated quite easily through the magnesium salts, and this affords a method for obtaining the valuable *o*-aminobenzenesulfonic acid. The preparation of orthanilic acid starting with *o*-nitrochlorobenzene has also been described.³⁷

It is to be observed that other *m*-nitrosulfonic acids also form very insoluble ferrous salts. One example is 2-nitro-4,8-naphthalenedisulfonic acid which can be obtained in a pure state very easily by this method.³⁸ This method of separation has long been known in the industry. For information about 2-naphthylamine-4,8-disulfonic acid, see page 219 ff.

Analogous Sulfonations. Exactly the same method can be used for sulfonating *p*-nitrochlorobenzene, *p*-nitrotoluene, *o*-nitrochlorobenzene, chlorobenzene, and many other compounds. On the other hand, it is usually not possible to sulfonate dinitro compounds in this way. Dinitrochlorobenzene and dinitrotoluene are decomposed explosively by treatment with fuming sulfuric acid. If dinitrochlorobenzenesulfonic acid is to be prepared, for example, one starts with *p*-nitrochlorobenzene. This is sulfonated, as described previously, and the sulfonic acid is converted to dinitrochlorobenzenesulfonic acid by treatment with mixed acid (50:50 sulfuric and nitric acids) at low temperatures. This product yields, on replacement of the chlorine by —OH and partial reduction, 4-nitro-2-aminophenol-6-sulfonic acid (nitro acid III), which is used in preparing chrome dyes.

Dinitronaphthalenes are converted to naphthazarin by oleum.³⁹

Technical Observations. Sulfonations of this type are carried out on a large scale in kettles provided with jackets through which either steam or cooling water can be circulated as desired. The reaction mixtures often become quite hot, and the operations must be conducted carefully so that dangerous overheating and explosion are avoided. Salting out is done in wooden vats, and the precipitate

³⁶ Obermiller, Ger. Pat. 281,176 (1914) [*Frdl.*, 12, 125 (1914-1916); *C.A.*, 9, 1830 (1915)].

³⁷ Fierz, Schlittler, and Waldmann, *Helv. Chim. Acta*, 12, 663 (1929).

³⁸ I.G., Fr. Pat. 734,616 (1932) [*C.A.*, 27, 1002 (1933)].

³⁹ W. Stockar, *Dissertation*, Eidg. Techn. Hochschule, Zürich, 1942.

is pressed out in filter presses exerting 250 atmospheres pressure. Reduction, evaporation, and working up of the reaction products, are carried out as described previously.

2,2'-Benzidinedisulfonic Acid from Nitrobenzene

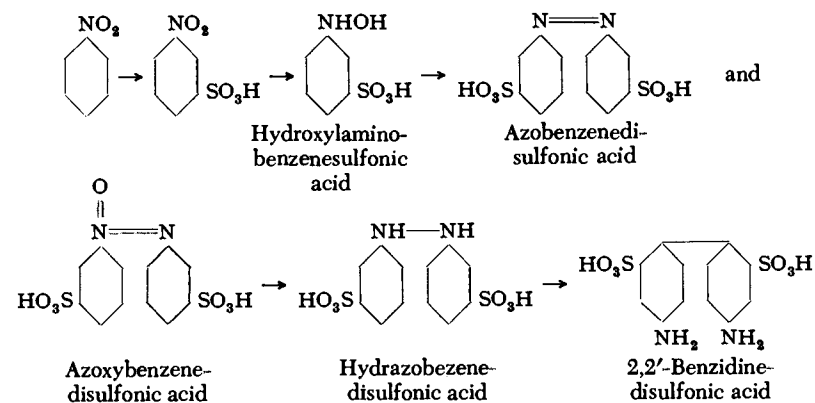

Nitrobenzenesulfonic acid is prepared as described under metanilic acid. The reduction is different from similar reactions only in that it is carried out in dilute aqueous solution in three distinct steps, making it possible to obtain the benzidinedisulfonic acid with a minimum amount of zinc dust and sodium hydroxide.

If the sodium salt is not entirely pure, the press cake of sodium nitrobenzenesulfonate, from 100 grams of nitrobenzene, is dissolved in water and about 30 grams of soda ash is added to make the solution exactly neutral to litmus. The solution is made up to 1.5 liters and cooled to 10°C. and 10 grams of ammonium chloride is added. While the solution is stirred vigorously, 120 grams of zinc dust is added portionwise over a period of 2 minutes. The temperature is kept below 20° by the addition of finely shaved ice, and stirring is continued for 20 minutes. Then 120 grams of 30 per cent sodium hydroxide is added in one portion and the solution is warmed to 70° without stirring. The solution, which was colorless, immediately turns orange yellow as a result of the formation of azo- and azoxybenzenedisulfonic acids. It is now allowed to stand at least 3 hours, or better, overnight.

The solution is then carefully neutralized by the dropwise addition of about 90 grams of concentrated hydrochloric acid to the point where the reaction to thiazole paper disappears. It is then heated to 80°, and 40 grams of zinc dust is added. If the solution is not decolorized in 5 minutes, more hydrochloric acid is dropped in slowly, keeping the tempera-

ture at 75–80°. The solution is decolorized, i.e., is changed from a dirty brown to a light gray, in less than 5 seconds after the neutral point has been reached. The solution, whose volume should be about 1.8 liters, now contains the hydrazobenzenedisulfonic acid. It is filtered immediately in order to prevent further reduction to metanilic acid, washing the zinc dust well. The filtrate is cooled to 20°, and 120 grams of concentrated hydrochloric acid is added. After a few minutes, a shiny precipitate of colorless, hard crystals of 2,2'-benzidinedisulfonic acid begins to form, and the solution turns yellow due to partial disproportionation yielding azobenzenedisulfonic acid and metanilic acid. A few grams of zinc dust is added to decolorize the solution. Although benzidinedisulfonic acid is extremely insoluble in water (1 liter of water dissolves less than 1 gram), the product separates very slowly. It should be allowed to stand for 2 days, then the precipitate is filtered off and washed with cold water. The yield is about 65 grams.

Technical Observations. In large scale operations, involving volumes of 4000 to 5000 liters, the crystallization of 2,2'-benzidinedisulfonic acid requires at least 3 days. In order to obtain rapid cooling, lead coils, through which cold water is circulated, are installed in the wooden vats. The sulfonic acid must be diazotized indirectly because of its insolubility. It is dissolved in the required amount of water and soda, the neutral solution is mixed with sodium nitrite, and the mixture is allowed to flow in a thin stream into hydrochloric or sulfuric acid.

As with all benzidine derivatives with substituents in the position ortho to the diphenyl bond, 2,2'-benzidinedisulfonic acid gives no substantive cotton dyes, but, in general, yields acid wool dyes of exceptional stability to washing and milling (e.g., acid anthracene-red G, page 294). Its combination with 2 moles of salicylic acid is a valuable dye for chrome printing on cotton (chromocitronine, page 295).

Benzidine from Nitrobenzene

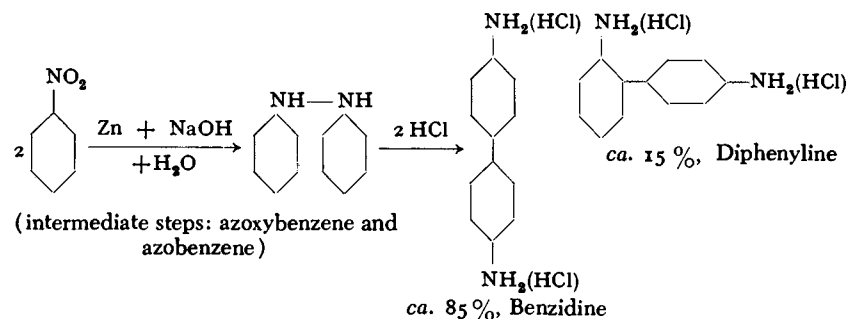

In a glass flask equipped with an efficient stirrer and a reflux condenser is placed a mixture of 125 grams of nitrobenzene and 250 cc. *o*-dichlorobenzene (solvent naphtha of boiling point about 170°C. can also

be used). To this mixture are added, alternately, zinc dust mixed with *o*-dichlorobenzene to form a thin paste, and 50 per cent sodium hydroxide solution. The nitrobenzene-*o*-dichlorobenzene mixture is first heated to 115–125°, then 5 cc. of the hydroxide solution is added, followed by 10 grams of the zinc dust paste. Reduction should take place rapidly, but, if not, the mixture is heated to 130°. Once the reaction has commenced, the alternate additions of the reagents are made at such a rate that the temperature remains at 115–120°. Care should be taken that some of the unreacted zinc dust does not settle to the bottom of the flask, or the reaction may suddenly become violent. The additions should be complete after about 3 hours. About 250 grams of the sodium hydroxide solution and about 260 grams of zinc dust are used. The reaction mixture first becomes red, then gradually decolorizes and turns white due to the sodium zincate hydrate. Stirring is continued until the mixture is completely decolorized, which may require 4 to 10 hours, depending on the manner in which the reaction is carried out and on the quality of the zinc dust used. If the reduction to hydrazobenzene is still incomplete after an even longer time, a few cubic centimeters of water is added carefully, and then, if necessary, a little more zinc dust and sodium hydroxide.

When the reduction is complete, water is added in small portions until the zinc sludge separates from the hydrazobenzene solution in a sharp layer. The *o*-dichlorobenzene layer is drawn off and the zinc sludge is washed twice with small portions of *o*-dichlorobenzene.

Rearrangement of Hydrazobenzene to Benzidine. The *o*-dichlorobenzene solution of hydrazobenzene is mixed with an equal weight of finely pulverized ice to which 300 cc. concentrated hydrochloric acid has been added. The benzidine hydrochloride which is formed (along with the by-product, diphenylene) goes into the water layer. After 3 hours, the mixture is warmed to 80°, 500 cc. hot water is added, and the *o*-dichlorobenzene layer is separated and washed twice with water. If the water layer is cloudy, it is filtered hot.

The solution of benzidine hydrochloride is mixed with good stirring with a solution of 100 grams of anhydrous sodium sulfate (or the corresponding amount of the hydrated salt). The relatively insoluble benzidine sulfate precipitates immediately, while the by-products remain in solution. After an hour, the sulfate is filtered off and washed well with water. [Note: if, in the rearrangement, the solution becomes red (formation of azobenzene), a few grams of iron shavings is added to give complete reduction.]

Preparation of the Free Base. The moist benzidine sulfate is stirred with a fivefold quantity of hot water and treated with enough solid soda

ash (about 45 grams) to give a definite and permanent alkaline reaction with litmus. The free base is filtered off and washed with water. It is obtained in the form of gray grains, which are dried at 100°. The product may be purified by distillation in vacuum (sausage flask). Its melting point is 128°. A yield of about 75 per cent of the theoretical amount is obtained, the remainder going into diphenylene and other by-products.

Technical Observations. The manufacture of benzidine is one of the most important operations of dye chemistry, because this base is used in the preparation of numerous valuable, although generally unstable, direct dyes. Similar methods are used to prepare the tolidines (ortho and meta) from *o*- and *m*-nitrotoluenes, and *o*-dianisidine from *o*-nitroanisole. Dyes from *m*-tolidine will rarely go on cotton, but they are interesting wool dyes.

The precipitate of zinc dust and zinc oxide is spontaneously inflammable and hence should not be discarded in the waste jar.

In addition to the method described, which is the one commonly used, the reduction can also be effected with iron shavings. This method, however, is difficult to carry out. There is also the electrolytic method in which nitrobenzene, in suspension in sodium hydroxide solution, is reduced to hydrazobenzene at the cathode. So far as is known, this method is used only by the *Gesellschaft für Chemische Industrie in Basel*. It does not require zinc dust and gives good yields. The best results are obtained when the specific gravity of the hydroxide solution equals that of nitrobenzene.

Distilled benzidine usually gives better results than the undistilled material, but it is somewhat more expensive. Only a little loss is entailed in the distillation, the residue being made up largely of impurities.

In the industrial preparation of benzidine derivatives, 200 to 500 kilograms of the nitro compound is reduced at one time — the operation requiring rather large apparatus. Less solvent can be used in these large scale operations than in the laboratory preparation because more efficient stirring can be used. The reduction requires about 24 hours. In the laboratory, the reduction, carried out according to the above procedure, succeeds only if the reaction mixture is thoroughly churned up. If this thorough mixing is not possible, as, for example, when working with very small quantities, better results are obtained if the *o*-dichlorobenzene is replaced by a water-miscible solvent such as alcohol.

8. Derivatives of Aniline

Sulfanilic Acid from Aniline (Baking Process)

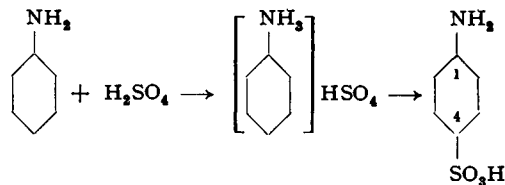

In an iron dish, 105 grams (1.0 mole) of sulfuric acid (66° Bé) is poured, in a thin stream with good stirring, into 93 grams (1.0 mole) of

aniline. Industrially, this operation is carried out in an iron kettle and the mixture is stirred by hand with an iron rod. The resulting hot, thick paste is spread out on an iron plate (15 × 15 cm.) having a rim about 2 cm. high. The layer should be about 1 cm. thick. In the plant, layers up to 8 cm. thick are used. The mass is placed in a drying oven, at least 5 cm. from the flame, and heated for 8 hours at an air temperature of 190°C. The cake is then removed from the oven and knocked from the plate. The light gray product consists of about 90 per cent of sulfanilic acid and about 3 per cent of unchanged aniline along with a small amount of carbon. This crude sulfanilic acid can be used directly for many purposes by dissolving it in a carbonate solution in order to make a solution strongly alkaline to litmus; in this preparation, 60 grams of soda ash in 500 cc. water is used. This solution is boiled, maintaining the volume by replacing the water distilled out, until all of the easily volatile aniline has been steamed out. The remaining solution, after being filtered through cotton, meets the requirements for most industrial uses. In order to obtain pure sulfanilic acid, the solution is made strongly acid to Congo red with sulfuric acid, whereupon the sulfanilic acid precipitates in high purity, although it is still not sufficiently pure for analytical purposes (see Analytical Section). The yield of crude material is about 175 grams; after purification by precipitation, the product weighs about 140 grams.

The Baking Process in General

Just as with aniline, many other aromatic amines (e.g., toluidine, xyldine, chloroaniline, α -naphthylamine, benzidine, aminoanthraquinone, and others) are converted into sulfonic acids by the so-called baking process as described above.⁴⁰ In contrast to the usual sulfonation procedures which use an excess of sulfuric acid or oleum, this process uses only the theoretical quantity of sulfuric acid and, as a result, the formation of higher sulfonation products is excluded. Isomeric by-products are not formed, as a rule. The sulfo group almost always enters the position para to the amino group, or if this position is occupied, it enters the ortho position. The sulfo group never goes into the meta position, nor does it enter another ring if one is present. It is generally assumed that the reaction involves a preliminary formation of a sulfamic acid by splitting out of water, followed by a rearrangement to the aminosulfonic acid. This explanation cannot be correct, however, because tertiary amines (e.g., dimethylaniline) are also sulfonated in the baking process, even though the formation of intermediate sulfamic acids is not possible.

In order to achieve a smooth reaction, it is important that the acid sulfate be homogeneous and not contain local excesses and deficiencies of sulfuric acid. This is not easy to attain in practice, because clumping tends to occur when the acid and base are mixed, and thorough mixing is very difficult. It is often of help to use diluted sulfuric acid and, in the case of solid amines, to use a solvent for the base

⁴⁰ Huber, *Dissertation*, Zürich, 1931.

(see the preparation of naphthionic acid, page 180); in these cases, the water must be driven off completely at a temperature below that of the reaction. In order to have uniform heating of the reaction mixture during the baking, the mixture should be spread out in a thin layer.

The optimum temperature lies between 170 and 220°C.; it varies with different compounds and must be established by experiment for each individual case.

It is highly advantageous to carry out the reaction under vacuum. In this way, the danger of carbonizing is avoided and the sulfonation proceeds more smoothly and rapidly. For these reasons, modern plants use vacuum baking ovens almost exclusively, heated either directly by flame, or, better, by superheated steam. Electrical heating can also be used, having the advantage of easy controllability. A vacuum apparatus suitable for laboratory use is described on page 181 (Fig. 30).

1-(*p*-Sulfophenyl)-3-methyl-5-pyrazolone from Sulfanilic Acid

(a) Phenylhydrazine-*p*-sulfonic Acid

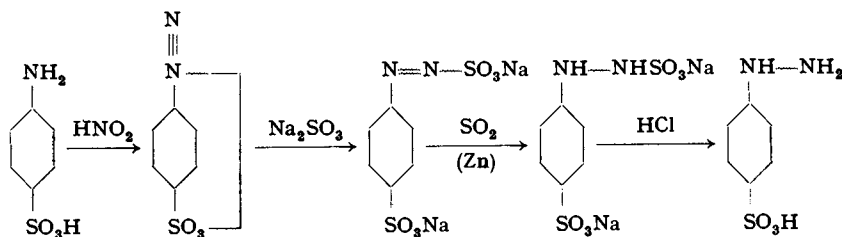

A quantity of technical sulfanilic acid corresponding to 104 grams (0.6 mole) of 100 per cent material is dissolved in 400 cc. hot water containing 33 grams of soda ash. The solution is filtered and cooled, and 70 grams of concentrated sulfuric acid is added slowly with stirring. The solution is then cooled in an ice bath, and a solution of 42 grams of sodium nitrite in 100 cc. water is added dropwise over a period of 15 minutes, keeping the temperature below 12°C. Stirring is continued for another 15 minutes, after which the solution should show a strong acid reaction to Congo red and give a faint blue coloration on starch-iodide paper. If the latter is not the case, a few drops more of nitrite solution are added. The crystalline diazonium compound is filtered off with suction and washed with a small amount of cold water to remove the excess sulfuric acid.

The still *moist* (*dry* diazosulfanilic acid may explode violently!) diazonium compound is added slowly to a vigorously stirred solution of 340 grams of crystalline sodium sulfite ($\text{Na}_2\text{SO}_3 \cdot 7\text{H}_2\text{O}$) in 500 cc. water

which is cooled in an ice bath, the addition being made at such a rate that the temperature remains below 5°. The solution becomes orange in color, but should not be turbid; it should be faintly alkaline to phenolphthalein. Stirring of the cold solution is continued for 1 hour, then the solution is heated to boiling and, while boiling and stirring are continued, 400 cc. concentrated hydrochloric acid (21° Bé) is added over a period of 30 minutes. The solution lightens in color, finally becoming very light yellow. The last traces of color are removed by the addition of a little zinc dust. The phenylhydrazinesulfonic acid precipitates, in large part, out of the hot solution in white plates. The mixture is cooled overnight, and the precipitate is filtered off, washed with cold water, and dried in a steam heated oven. The yield is 106 grams, or 94 per cent of the theoretical amount. Concentration of the mother liquor to one-half its volume yields an additional few grams.

(b) *p*-Sulfophenyl-3-methyl-5-pyrazolone

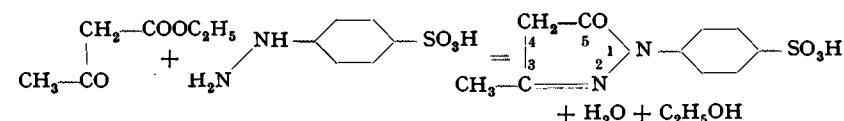

A solution is made of 18.8 grams (0.1 mole) of phenylhydrazine-*p*-sulfonic acid in 50 cc. hot water containing 6 grams of soda ash. The solution is filtered hot, and the small excess of soda is neutralized with dilute hydrochloric acid, making the solution neutral to litmus. After cooling the solution, 13 grams of acetoacetic ester is added slowly with stirring, and the solution is heated to 100°C. and stirred for 45 minutes at this temperature. The mixture is then cooled with stirring and acidified with 18 cc. concentrated hydrochloric acid. The precipitated pyrazolone is filtered off with suction, washed with cold water, and dried. The yield of slightly yellow powder is 24 grams, or 94 per cent of the theoretical amount.

Technical Observations. Phenylmethylpyrazolonesulfonic acid is used, for example, in the preparation of fast light yellow G (page 265). Phenylmethylpyrazolone itself (from phenylhydrazine and acetoacetic ester) and many of its derivatives are valuable components for the preparation of yellow azo dyes which, for the most part, are characterized by very high stability.

Phenylmethylpyrazolone is also a very important starting material for certain pharmaceutical products (antipyrine, pyrimidone, etc.).

p-Aminoacetanilide from Aniline

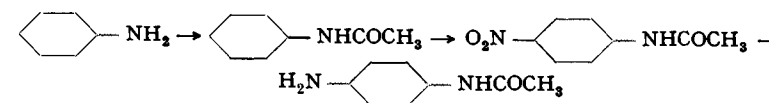

(a) Acetanilide from Aniline

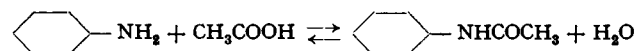

The reaction is carried out in a 500-cc. round-bottomed flask, heated by an oil bath, and fitted with a fractionating column, preferably of the type described on page 342. The column should be at least 20 cm. long and filled with glass rings; it should be insulated and equipped with a partial condenser cooled by a stream of air.

In the reaction flask are placed 186 grams (2 moles) of aniline and 180 grams (3 moles) of glacial acetic acid, a boiling chip is added (the mixture tends to bump badly), and the mixture is heated to gentle boiling (oil bath temperature 150–160°C.). As soon as the column has become warm and the vapor has reached the partial condenser, a rather strong stream of air is passed through the latter. Most of the vapor condenses and returns to the column, and only a very slow distillation takes place, the temperature being 102° at the most. After about 1 hour, the distillation almost stops, and the temperature of the oil bath is raised to 190° during the course of the next hour. It is held at this temperature until distillation at a temperature of 102° again ceases. At this point, 45 to 50 grams of distillate has been collected, consisting of 30 to 40 per cent acetic acid. Another 60 grams of glacial acetic acid is now added to the reaction mixture, and the distillation is continued for about 1 hour more, the distilling temperature staying between 100 and 102° with an oil bath temperature of 180–190°. The acetylation, which is now nearly completed, is finished by raising the oil bath temperature slowly to 220°; the distillation temperature increases to about 110° as the distillate becomes poorer in water. The heating is continued until a test of the reaction mixture shows the absence of aniline. This test is made by removing a drop of the mixture on a glass rod, mixing it with a little ice and dilute hydrochloric acid, and adding a few drops of nitrite solution. If aniline is present, benzene diazonium chloride is formed, which gives an intense orange red color when the solution is added to an R salt solution containing soda. If the test for aniline is negative, the oil bath is allowed to cool to 180°, the column is removed, and the remainder of the acetic acid is distilled out in vacuum at an oil bath temperature of 180°. For this operation it is desirable to install a capillary tube to draw air through the mixture. The residue is poured, while still hot, into a porcelain dish or onto a copper plate, where it solidifies to a crystalline mass. The product is colorless if the aniline used was colorless. The material melts at 114–

115°. The yield is at least 265 grams, or 98 per cent of the theoretical amount.

The crude material can be used without further treatment for the following nitration step. Especially pure acetanilide, such as is required for pharmaceutical purposes, can be obtained by recrystallization from boiling water, yielding completely colorless and odorless, shiny plates.

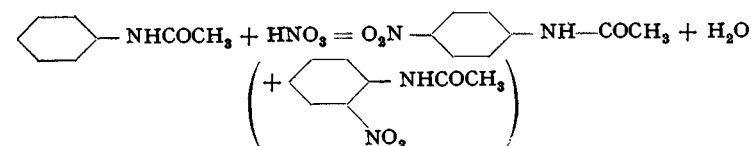
(b) *p*-Nitroacetanilide from Acetanilide

In a tightly covered iron beaker (see Fig. 19) or a three-necked flask, fitted with thermometer and dropping funnel, a mixture is made with stirring, of 135 grams (1.0 mole) of finely powdered, dry acetanilide and 540 grams of concentrated sulfuric acid (66° Bé). The temperature should not rise above 25°, or hydrolysis of the acetanilide may occur. The acetanilide dissolves completely in 1 to 2 hours. The clear solution is cooled in an ice-salt mixture (in order to obtain an efficient freezing mixture, it is absolutely necessary to *weigh out* the constituents—3 parts of finely divided ice and 1 part of salt—and mix them thoroughly) and a mixture of 105 grams of 62 per cent nitric acid (40° Bé) with 105 grams of sulfuric acid (66° Bé) is added from the dropping funnel over a period of about 1 hour. The reaction temperature should not exceed 2–3°; preferably, it should be kept even lower, down to about –5°, since the lower the temperature, the less of the *o*-nitro compound is formed. Under the right conditions, such as prevail in industrial operations, the theoretical amount of nitric acid can be used. A *small* excess does no harm, however, because the entrance of a second nitro group into the molecule takes place only with some difficulty. Stirring at 0° is continued for about 3 hours after the mixing is completed, and then a nitrometer test (page 72) is made to see whether the nitric acid remaining corresponds to the small excess used. An additional test is also made by mixing a small test sample with water, adding sodium hydroxide, and boiling. No odor of aniline should be noticeable.

The reaction mixture is poured, with good stirring, into a mixture of 350 cc. water and 350 grams of ice. The nitroacetanilide precipitates im-

mediately, and after an hour it can be filtered off without loss. It is washed thoroughly with water, then slurried with 700 cc. water, enough soda is added to make the mixture distinctly alkaline to litmus, and the mixture is heated to boiling. This treatment hydrolyzes only the *o*-nitroacetanilide. The residue is filtered off at 50° and washed thoroughly with water, yielding about 90 per cent of the theoretical amount of *p*-nitroacetanilide.

The acetyl derivative can be hydrolyzed with sodium hydroxide. The moist press cake of *p*-nitroacetanilide is mixed with an equal weight of water, 200 grams of 35 per cent sodium hydroxide is added, and the mixture is heated to boiling. This treatment hydrolyzes only the *o*-nitro-3 hours, a test sample should dissolve to form a clear solution in 15 per cent hydrochloric acid, showing complete hydrolysis. The mixture is cooled to 40° and filtered. The product, washed carefully with cold water, is chemically pure. The yield for 93 grams of aniline is about 100 grams of *p*-nitroaniline.

(c) *p*-Aminoacetanilide from *p*-Nitroacetanilide

This azo dye component is obtained from *p*-nitroacetanilide by neutral reduction, using a procedure almost exactly like several that have already been described. In an iron beaker equipped with a stirrer (Fig. 17), a mixture of 250 grams of pulverized cast iron shavings, 15 cc. 40 per cent acetic acid, and 500 cc. water, is boiled vigorously for a few minutes. The moist nitroacetanilide from 1 mole of acetanilide is added in small portions, and stirring and boiling are continued until a drop of the reaction mixture on filter paper appears colorless. Boiling is continued for 10 minutes longer, replacing the water lost by evaporation. The mixture is then cooled to 70°C., and enough soda is added to make the mixture faintly alkaline. The reduction of the *p*-nitroacetanilide from 93 grams of aniline can easily be completed in 20 minutes. If boiling is continued during the neutralization, or if too much soda is added, the aminoacetanilide may be hydrolyzed. The solution is not freed from iron at 70°, however, and the rest of the metal is precipitated with just the necessary amount of ammonium sulfide (to the point where a drop on filter paper gives no color with alkali sulfide). The mixture is then filtered.

The filtrate is evaporated to 400 cc. over a flame, and the aminoacetanilide separates in long needles when the concentrated solution is cooled. The yield from 93 grams of aniline is about 75 grams of pure base. The mother liquor, which contains about 15 per cent of impure material, is evaporated further and more product is crystallized out.

The material thus obtained is sufficiently pure for technical purposes. A completely pure product can be obtained by a second crystallization from 6 parts of water, preferably using decolorizing carbon. The product prepared on a large scale using vacuum evaporation is somewhat more pure.

Hydrolysis of aminoacetanilide yields the widely used *p*-phenylenediamine. This material is very easily oxidizable, and therefore, the hydrolysis must be carried out in the absence of air or by boiling with dilute sulfuric acid. *p*-Phenylenediamine can also be prepared by reduction of *p*-nitroaniline. It is used chiefly for the production of brown tints by oxidation on the fiber.

Technical Observations. Formanilide, which is less expensive, is used industrially instead of acetanilide in the preparation of *p*-nitroaniline. The nitration is carried out at a very low temperature (−20°C.) to minimize the formation of the ortho isomer. The by-product, *o*-nitroaniline, is also recovered; it finds limited use in azo dye manufacture, especially for the preparation of pigment colors (Hansa yellow 5G, lithol fast yellow R). Hydrolysis of nitroformanilide is done with the calculated amount of sodium hydroxide, and formic acid is recovered from the resulting sodium formate. This process was formerly used to supply the large demand for *p*-nitroaniline. Today it has been largely displaced by the process employing *p*-nitrochlorobenzene and ammonia (page 92). Economic factors determine which of the two processes is to be preferred.

Dimethylaniline (Diethyl- and Ethylbenzylanilines)

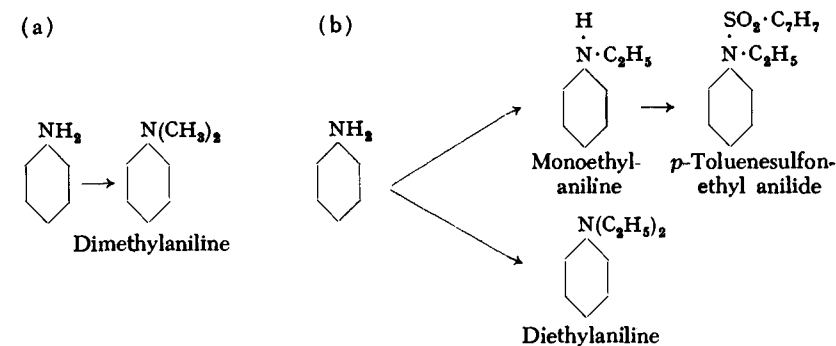

The preparation of dimethylaniline is carried out in an iron autoclave withstanding 60 atmospheres of pressure, provided with a cast iron lining, a manometer and an oil bath. The methyl alcohol used for the alkylation must be free from all traces of acetone and ethyl alcohol, because these compounds, as impurities, cause a very great increase in the pressure. The purity of the methyl alcohol should be established by an iodoform test.

The autoclave is charged with a mixture of 93 grams of pure aniline, 105 grams of pure methyl alcohol, and 9.4 grams of 94 per cent sulfuric acid (66° Bé), and is heated in the oil bath to 200°. The pressure is about 30 atmospheres. The reaction is kept at 215° for 6 hours, then cooled, and 25 grams of 30 per cent sodium hydroxide is added. The autoclave contents are now heated for 5 hours at 170° in order to split the ammonium base sulfates, which are decomposed only at elevated temperatures into sulfuric acid, alcohol, and a tertiary amine. (The formation of quaternary ammonium bases is especially pronounced in the preparation of ethylbenzylaniline and methylbenzylaniline.) The reaction mixture is then steam distilled, and the dimethylaniline is salted out of the aqueous distillate, separated, and distilled through a small bulb column. It is obtained almost chemically pure as a colorless liquid, b.p. 192°, in a yield of about 117 grams.

The purity of the product, which always contains a small amount of monomethylaniline, can be tested by mixing 4 cc. with 2 cc. acetic anhydride. The temperature of the mixture should not increase more than one degree.

Diethylaniline. The preparation of diethylaniline in the laboratory is equally simple. It must be carried out only in an enameled autoclave, however, because hydrochloric acid is used in place of sulfuric. The latter acid decomposes ethyl alcohol, giving water, ethylene, and carbon.

A mixture of 130 grams of dry aniline hydrochloride and 140 grams of 95 per cent ethyl alcohol is heated for 8 hours at 180°C. in an enameled autoclave. The pressure is about 30 atmospheres. If a stronger autoclave is available, it is advantageous to carry out the reaction at 200°, giving a pressure of 55 atmospheres. The contents of the autoclave are transferred to a glass flask, the alcohol and diethyl ether are distilled off, and the residual mixture of mono- and diethylaniline is treated with 100 grams of 30 per cent sodium hydroxide. The mixture is then stirred vigorously at room temperature with about 40 grams of *p*-toluenesulfonyl chloride, which converts the monoethylaniline into *p*-toluenesulfonethylanilide which is not volatile with steam. In this way, the diethylaniline can be obtained completely pure, although an acetic anhydride test for purity should be made, and the treatment with toluenesulfonyl chloride repeated if necessary. The yield is about 120 grams.

The recovered toluenesulfonyl derivative can be hydrolyzed with concentrated sulfuric acid, and the monoethylaniline recovered.

The method above for producing dimethyl- and diethylaniline is not completely satisfactory, but is suitable for small scale work. A cheaper method involves the use of less alcohol and acid, the reaction mixture being hydrolyzed directly with sodium hydroxide. The monoalkylated base is not separated from the dialkylated compound, but is converted to the alkylbenzyl derivative by means of benzyl chloride. The dialkylaniline and alkylbenzylaniline have boiling points which are far enough apart so that the compounds can easily be separated by vacuum fractional distillation. The following preparation illustrates this procedure.

Ethylbenzylaniline. A mixture of 260 grams of dry aniline hydrochloride and 150 grams of ethyl alcohol is heated in an enameled autoclave for 12 hours at 200°C. The pressure is 21 atmospheres. The mixture is treated as described under

diethylaniline, except that it is not treated with *p*-toluenesulfonyl chloride. The mixture of bases obtained weighs 230 grams; it is practically free from aniline and contains about 38 per cent of diethylaniline and 62 per cent of monoethylaniline.

100 grams of this mixture is placed in a 500-cc. three-necked flask fitted with stirrer, reflux condenser, and dropping funnel, and is mixed with 60 grams of soda which has been moistened with a few drops of water. The well stirred mixture is heated to 50°, and 68 grams of benzyl chloride is added slowly from the dropping funnel. (This is about 5 per cent excess based on the amount of monoethylaniline as determined from the density of the mixture; see table on page 136.) When the addition of the benzyl chloride is completed, the temperature is raised to 100°, and the mixture is stirred at this temperature until the formation of gas bubbles ceases (about 3 hours). It is then poured into water to remove the inorganic salts, and the oil layer is separated and fractionated in vacuum. The separation is easily accomplished due to the large difference in boiling points. About 38 grams of diethylaniline (complete recovery of the amount present in the original mixture of bases) and about 100 grams of ethylbenzylaniline are obtained.

Mono- and diethylanilines can also be separated by treating the mixture with concentrated hydrochloric acid. The hydrochloride of monoethylaniline crystallizes out and is separated by centrifuging, permitting the recovery of most of the monoethylaniline as such. The residual mixture can be treated with benzyl chloride and soda, as described above, converting it into a mixture of diethylaniline and ethylbenzylaniline.

Technical Observations. Heating of the large autoclaves used in industrial preparations requires from 4 to 6 hours and must be done very carefully. When a temperature of about 190°C. is reached, the pressure increases rapidly from 10 to 30 atmospheres. At the end of the reaction, the excess methyl alcohol, along with the ether formed, is blown out and the vapor is condensed. Splitting of the quaternary ammonium base is carried out in large kettles, using 3000 to 5000 kilograms of dimethylaniline.

Various methods can be used to determine the amounts of monoethylaniline and diethylaniline in a given mixture. One method⁴¹ depends on the determination of the temperature increase occurring when a prescribed amount of the base mixture is mixed with an accurately measured amount of pure acetic anhydride. More reliable and accurate results are obtained, however, by determining the specific gravity of the mixture. From the table below, the composition of the mixture can be determined directly, and with great accuracy, from the density at 15°. It is necessary, of course, that no unchanged aniline be present. This condition is fulfilled in the procedures described above.

The laboratory separation of larger amounts (1 kilogram or more) of mixtures of mono- and diethylanilines can be accomplished relatively easily by fractional distillation, using a column 100 cm. long and 5 cm. wide which is filled with 1-cm. glass Raschig rings. The rings should be supported on a wire gauze with large openings so that the returning liquid is not held up. The column should be insulated to within 10 cm. of the top with asbestos paper. A copper flask is used as the distillation flask, since this gives steady boiling.

The specific gravities (at 15°C.) and boiling points, respectively, of monoethylaniline and diethylaniline are:

Monoethylaniline, 0.9643 at 15°C., 204°C.

Diethylaniline, 0.9389 at 15°C., 214°C.

The values given in the table below are slightly different from those in the literature, but they are derived from our own research (G. Widmer).

⁴¹ Lunge and Berl, *Chemisch-technische Untersuchungsmethoden*. 6th ed., Vol. IV, Springer, Berlin, 1910-1911, p. 625.

Per Cent Diethylaniline from the Density of Mixtures of Monoethylaniline and Diethylaniline at 15°C.

Density	Diethylaniline %	Density	Diethylaniline %	Density	Diethylaniline %
0.9646	0	0.9565	33.2	0.9470	70.0
0.9643	1	0.9560	35.2	0.9465	71.9
0.9640	2.3	0.9555	37.2	0.9460	73.8
0.9637	3.7	0.9550	39.1	0.9455	75.6
0.9634	4.8	0.9545	41.0	0.9450	77.5
0.9630	6.4	0.9540	43.0	0.9445	79.4
0.9626	8.2	0.9535	45.0	0.9440	81.3
0.9622	9.8	0.9530	47.0	0.9435	83.2
0.9618	11.6	0.9525	48.9	0.9430	85.0
0.9614	13.3	0.9520	50.8	0.9425	86.7
0.9610	15.0	0.9515	52.7	0.9420	88.4
0.9605	17.0	0.9510	54.7	0.9415	90.2
0.9600	19.1	0.9505	56.7	0.9510	92.1
0.9595	21.2	0.9500	58.6	0.9405	93.9
0.9590	23.3	0.9495	60.4	0.9400	95.6
0.9585	25.3	0.9490	62.3	0.9395	97.4
0.9580	27.3	0.9485	64.2	0.9390	99.2
0.9575	29.2	0.9480	66.1	0.93875	100.0
0.9570	31.2	0.9475	68.0		

Ethylbenzylanilinesulfonic Acid ⁴²

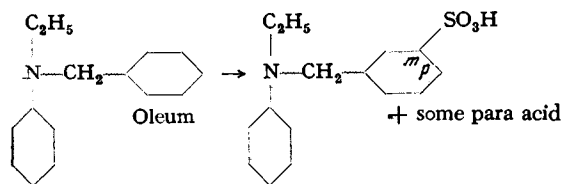

In a glass flask equipped with a stirrer is placed 150 grams of 100 per cent sulfuric acid and to this is added carefully, over a period of 15 minutes, 150 grams of ethylbenzylaniline, maintaining the temperature of the mixture below 50° by means of external cooling. Then 150 grams of oleum (60 per cent SO₃) is added slowly, and the mixture is held at 60° until a small test sample shows no turbidity when diluted with water and neutralized with dilute soda solution. This usually requires about 3 hours. The reaction mixture is then poured into 1 liter of water, and after 12 hours the free sulfonic acid which has separated is filtered off

⁴² Blangey, Fierz, and Stamm, *Helv. Chim. Acta*, 25, 1162 (1942).

and washed with water, giving a pure fraction of about 72 per cent of the theoretical yield. The mother liquor, containing sulfuric acid, can be neutralized with lime, treated with sodium sulfate, filtered to remove CaSO₄, and evaporated to 400 cc. There is obtained — frequently only after scratching with a glass rod or seeding — a second portion of the same sulfonic acid, amounting to about 5 per cent of the theoretical amount. The second mother liquor yields the sodium salt of the isomeric para acid on treatment with salt (about 15 per cent yield).

Tetramethyl-*p,p'*-diaminodiphenylmethane from Dimethylaniline and Formaldehyde

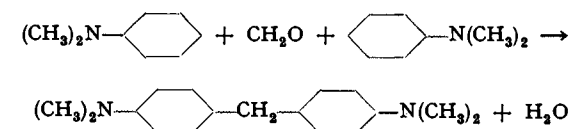

A mixture of 242 grams (2 moles) of dimethylaniline, 90 grams (1.0 mole + 20 per cent excess) of 40 per cent aqueous formaldehyde, and about 1 gram of pure sulfanilic acid, is boiled under reflux with vigorous stirring. No visible change in the reaction mixture occurs, and after 8 hours a small sample of the light yellow emulsion is pipetted out and cooled. The oil should solidify completely, and on heating, the mixture should have only a faint odor of dimethylaniline. Otherwise the boiling under reflux should be continued for a longer time.

When the reaction is complete, the reaction mixture is steam distilled until no more dimethylaniline and formaldehyde come over. The distillate should contain only a few drops of dimethylaniline. The residue is poured into a large volume of cold water, whereupon the base solidifies immediately. The water is decanted and the solid lumps washed thoroughly several times with water to remove formaldehyde. The product is finally melted under water and allowed to solidify.

The base obtained in this way is a hard, yellowish white, crystalline mass with melting point between 80 and 90°C. One recrystallization from 500 cc. alcohol yields the pure base in nearly white, glistening crystals having the correct melting point of 91°. The yield of crude material is quantitative; that of recrystallized base is over 90 per cent of the theoretical amount.

Tetramethyldiaminodiphenylmethane ("methane base" in the industry) is the starting material for the preparation of auramine (q.v.). By oxidation with lead dioxide, it yields tetramethyldiaminobenzohydrol (see next preparation).

hours, and the mixture is held at this point for 12 hours. It is finally stirred for 2 hours at 80°.

The reaction is now completed. The mixture is diluted with 5 liters of water, and concentrated hydrochloric acid (about 40 grams) is added until the odor of dimethylaniline disappears. Unchanged dimethylaniline and some of the by-products go into solution, while Michler's ketone, being appreciably less basic, remains undissolved. The solid material is filtered off and washed, then heated with 5 parts of water. In case the odor of dimethylaniline again appears, a small amount of concentrated hydrochloric acid is added. The ketone is now filtered off and dried at 100°. The yield is 177 grams, or about 66 per cent of the theoretical amount.

If necessary, the technically pure ketone can be recrystallized from kerosene (b.p. 180°C.). In large scale operations, the product is heated to 140° with this solvent and is allowed to cool. Michler's ketone, purified in this way, melts at 170–172°.

Tetraethyldiaminobenzophenone is prepared in an analogous manner. This ketone is purified through its acid sulfate which crystallizes beautifully.

Technical Observations. Michler's ketone and its homologs are important starting materials for the preparation of valuable triphenylmethane dyes such as Victoria blue B and Victoria pure blue BO.

Diphenylamine from Aniline and Aniline Salt

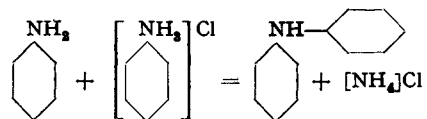

In an enameled autoclave having an enameled thermometer tube, 93 grams of aniline and 93 grams of aniline hydrochloride are heated for 20 hours at 230°C. The pressure rises to about 6 atmospheres. If there is no enameled thermometer tube, the pressure is brought to this point, and the temperature of the oil bath is taken as about 25° higher than the effective internal temperature. After 2 hours, the water vapor present is carefully blown out through the valve, since the reaction is adversely affected by even traces of water. The blowing out operation is repeated three times during the course of an hour — some aniline and ammonia also escaping. There is no advantage in heating longer than 20 hours, and in fact, the yield may even be lowered. After cooling the autoclave, its contents are transferred to a porcelain dish and treated with 1 liter of

water. The mixture is heated to 80°, and 30 per cent hydrochloric acid is added until an acid reaction to Congo red is obtained. After cooling overnight, the crude diphenylamine has separated as a solid mass which is easily separated from the mother liquor, since diphenylamine does not

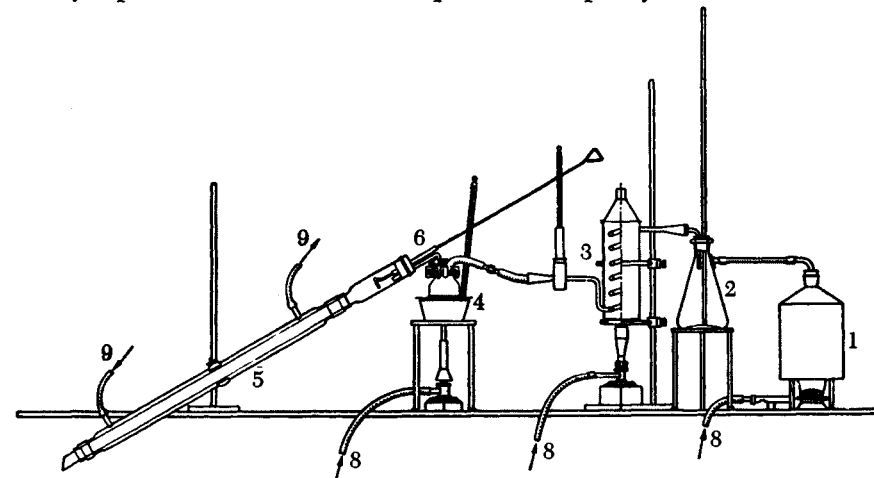
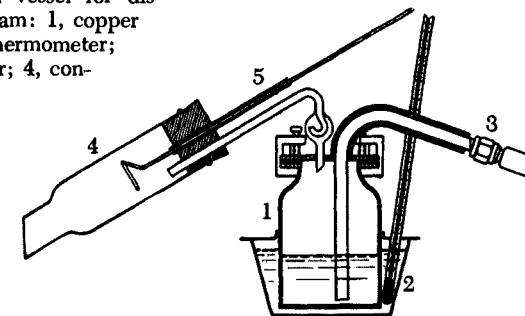

Fig. 23. (a) Laboratory apparatus for distilling with superheated steam: 1, steam generator; 2, water trap with vertical safety tube; 3, superheater; 4, distillation vessel in oil bath; 5, condenser with wide tube; 6, device for pushing out solid material collecting in the condenser; 7, receiver for distillate; 8, gas line; 9, cooling water. (b) Laboratory distillation vessel for distilling with superheated steam: 1, copper kettle; 2, oil bath with thermometer; 3, connection to superheater; 4, condenser; 5, push-out device.



form a salt with dilute hydrochloric acid. After filtering, the product is again melted with water, leached out with a little acid, and then washed with dilute soda solution. The diphenylamine obtained in this way is extremely impure.

The product must be purified by distillation with superheated steam. For this purpose, it is placed in a distillation flask of about 500-cc. capacity, and an apparatus such as that shown in Figure 23 is assembled.

The oil bath is heated to 250°, and the superheater is heated with an ordinary Fletcher burner. The steam must be dried carefully and its temperature should be about 300°. If the distillation is carried out well, 1 part of base can be distilled with 2 parts of water. The diphenylamine is obtained as a colorless liquid which solidifies to a light yellow cake. It is obtained completely pure by pouring off the water. The yield of product melting at 51° is about 100 grams. About 35 grams of aniline can be recovered from the acidic mother liquors.

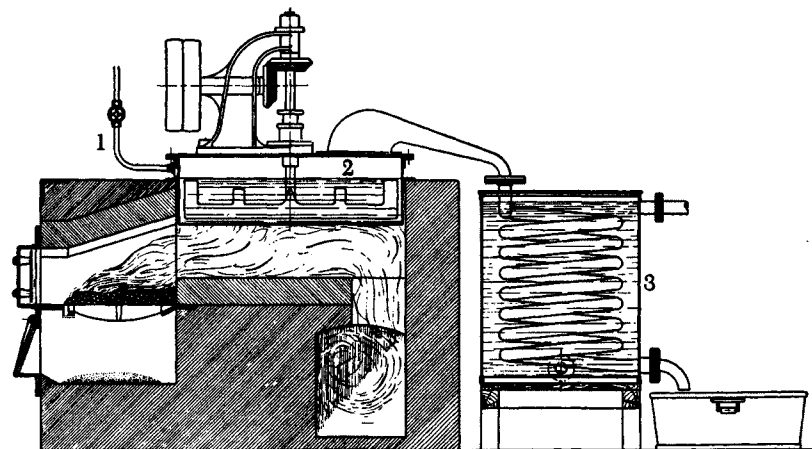
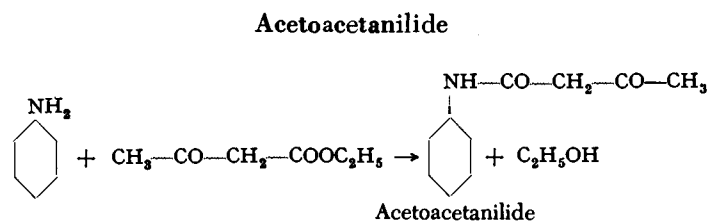
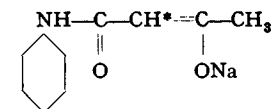

Fig. 24. Apparatus for large-scale distillation with superheated steam (for α -naphthylamine, diphenylamine, etc.): (1) inlet for superheated steam; (2) distillation vessel with slow stirrer; (3) coil condenser.

Technical Observations. Not only the autoclave proper, but also the cover, must be enameled. Traces of iron or copper reduce the yield of diphenylamine by as much as 30 to 50 per cent, and cause resinification. The hydrochloric acid extraction is carried out in wooden vats and the distillation with superheated steam is done in apparatus such as that shown in Figure 24. Modern devices are available for producing the superheated steam. It is possible to carry over nearly one part of diphenylamine with one part of water at 230°.



Acetoacetanilide reacts with NaOH to form:



In the coupling reaction with diazo compounds, the H* is replaced by the —N=N—R groups.

A mixture of 156 grams (1.2 mole) of freshly distilled acetoacetic ester (b.p. 65°C. at 12 mm.), 500 cc. dry toluene, and 0.5 cc. pyridine, is heated to 135° in a flask attached to a downward condenser. To the gently boiling mixture is added, during the course of 5 hours, a mixture of 93 grams (1.0 mole) of freshly distilled aniline, 250 cc. toluene, and 0.5 cc. pyridine. The toluene should distill out at about the same rate at which the addition is made. When the addition is completed, the reaction mixture is heated under reflux for 2 hours more. It should be slightly greenish in color, not red. The hot mixture is transferred to a beaker and allowed to cool, whereby pure white acetoacetanilide separates. After 12 hours, the product is filtered off, washed with 50 cc. toluene, and dried at 60°. The yield is about 150 grams, or 85 per cent of the theoretical amount. In some cases, by-products may be formed in small quantity along with the desired anilide. Their presence is recognizable immediately by failure of the acetoacetanilide to dissolve completely in dilute sodium hydroxide. Pure acetoacetanilide (m.p. 85°) is obtained by filtering the alkaline solution and acidifying the clear filtrate with dilute hydrochloric acid.

Technical Observations. Acetoacetanilide is used in the preparation of important insoluble pigment colors which are known under the trade name, Hansa yellow⁴⁴ (see page 266).

9. Derivatives of Benzenesulfonic Acid

Benzene-*m*-disulfonic Acid

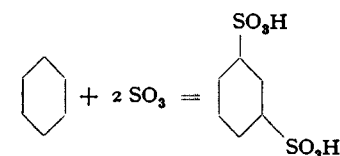

To 78 grams (1.0 mole) of benzene is added, with good stirring over a period of 2 hours, 250 grams of 20 per cent oleum, the addition being

⁴⁴E. Ziegler, *Dissertation*, Zürich, 1928. See also Fierz-David and Blangey, *Kunstliche organische Farbstoffe*, Ergänzungsband, Springer, Berlin, 1935, p. 58.

made at such a rate that the temperature does not rise above 40–45°C. During the next 2 hours, 200 grams of 66 per cent oleum is added, the temperature then rising to about 75°. Finally the mixture is heated at 90° for 1 hour more. The reaction mixture is then poured into 2 liters of water and the hot solution is neutralized by adding about 400 grams of chalk with stirring. The precipitated calcium sulfate is filtered off by suction and washed thoroughly with water. Soda ash (about 100 grams) is added to the hot filtrate until the mixture gives a weak red color with phenolphthalein paper, the filtrate is evaporated to dryness, and the residue is dried at 130–140°, giving a yield of product of about 250 grams, or 90 per cent of the theoretical amount.

Benzene-*m*-disulfonic acid is used in the preparation of phenol-*m*-sulfonic acid and of resorcinol. Further sulfonation of benzene-*m*-disulfonic acid to the trisulfonic acid is accomplished by heating the sodium salt for several hours at about 250°, in the presence of mercury, with 66 per cent oleum.

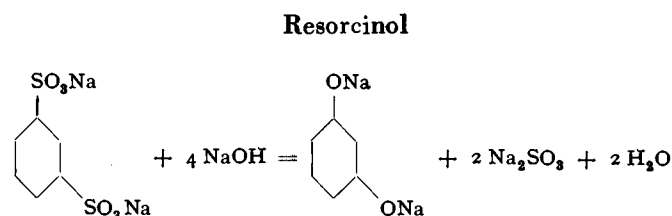

In the tray of a vacuum baking oven (Fig. 30, page 181), 32 grams (0.8 mole) of sodium hydroxide is dissolved in 20 cc. water by heating to 200° C., then 28.2 grams (0.1 mole) of sodium benzene-*m*-disulfonate (preceding preparation) is added and the mixture is stirred to form a homogeneous mass. The tray is placed in the oven, and the mixture is heated in vacuum, first to 200° to remove the water, then at 320° at a pressure of 12–15 mm. for 6 hours. The resultant cake, after cooling, is dissolved in a small amount of water, and the solution is made strongly acid to Congo red by the addition of concentrated hydrochloric acid and boiled to drive off the SO₂. The solution is filtered if necessary, and then extracted exhaustively with ether until the water layer no longer gives a test with FeCl₃. The ether extract is dried over anhydrous sodium sulfate, the solvent driven off, and the residue distilled in vacuum. At 12 mm., about 0.5 gram of phenol goes over at about 80° (collected separately), then at 156–159°, about 8.5 grams of pure white resorcinol, m.p. 109–110°. The yield is about 75 to 80 per cent of the theoretical amount.

The alkali fusion of benzene-*m*-disulfonic acid yields resorcinol only in the absence of water. With aqueous sodium hydroxide under pressure, phenol-*m*-sulfonic acid is formed, and if the temperature is increased, phenol and decomposition products are formed, but not resorcinol. The formation of some phenol as a by-product cannot be avoided completely.⁴⁵

The fusion is best carried out in vacuum, suitably in the vacuum baking apparatus used in the sulfonation of amines by the baking process. When the water is evaporated from the melt, the mass foams and, in order to avoid clogging the suction tube, this tube should be sufficiently wide and the tray should not be more than half filled. In order to obtain good yields, it is necessary to use about twice the sodium hydroxide required theoretically, i.e., about 8 moles per mole of sodium benzenedisulfonate.

10. Derivatives of Phenol

o- and *p*-Chlorophenol from Phenol

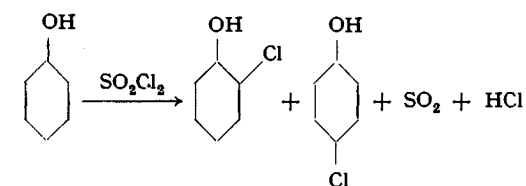

The two isomers are prepared by the method of Dubois (1866), by the action of excess sulfuryl chloride on phenol, and are separated by fractional distillation.

In a 1-liter three-necked flask fitted with a stirrer, thermometer, dropping funnel, and gas exit tube, is placed 380 grams (4 moles) of phenol, and 610 grams (4.5 moles) of sulfuryl chloride is added dropwise over a period of 12 hours while the temperature is maintained at 20–25°C. Stirring is continued for an additional 5 hours at 10°, and then air is blown through the mixture for another 12 hours.

The reaction mixture is then distilled in vacuum through a fractionating column. At a pressure of 20 mm., the *o*-chlorophenol goes over at 75–90°, the para isomer at 110–115°. About 130 grams of *o*-chlorophenol (25 per cent) and 320 grams of *p*-chlorophenol (62 per cent) are obtained.

Remarks. The action of free chlorine on phenol is so vigorous that trichlorophenol is formed at once. Monochlorophenol can also be prepared by adding the calculated quantity of sodium hypochlorite solution to a cold solution of phenol in sodium hydroxide; the product obtained by this method, however, is chiefly *o*-chlorophenol.

⁴⁵ Fierz and Stamm, *Helv. Chim. Acta*, 25, 364 (1942).

The chlorophenols have a *disagreeable, clinging odor* and must therefore be handled carefully.

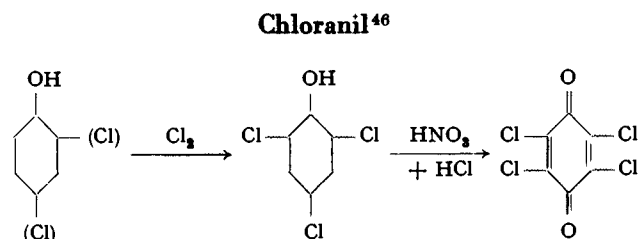

A 2-liter three-necked flask is fitted with a gastight stirrer (sealing liquid, either concentrated sulfuric acid or paraffin oil), gas introduction tube, and reflux condenser connected to a hood through a glass tube. In the flask are placed 47 grams (0.5 mole) of phenol, or 65 grams of *o*- or *p*-chlorophenol, and 1 liter of technical concentrated hydrochloric acid (21° Bé). Stirring is started, sufficiently vigorously to break up the mixture into very fine droplets, and a rather rapid stream of chlorine is introduced. The chlorine need not be specially dried, but it should be run through a wash bottle of sulfuric acid to show the velocity of the gas stream. The temperature rises to about 40°C. After 4 hours, the reaction flask is surrounded by a 70° water bath, and the introduction of chlorine is continued until the solution is completely saturated, requiring about 20 hours. As the chlorination proceeds, some crystals form on the upper part of the flask and in the condenser. When no more chlorine is being absorbed, the gas introduction tube is replaced by a dropping funnel, and 250 cc. nitric acid (40° Bé) is added over a period of 3 hours, while stirring is continued and the temperature is held at 80–85°. At first, a vigorous reaction takes place, but this soon subsides. The reaction mixture becomes red and the crystals dissolve. After the nitric acid has all been added, stirring is continued for 20 hours at a temperature of 85°. Heavy, plate-like, yellow crystals separate gradually. These are filtered off, after cooling, and washed first with 2 liters of water, then with 250 cc. alcohol to remove a reddish oily impurity. The product is then dried at 80°. It melts at 285–286° and is practically pure chloranil. The yield is 70 to 75 grams, or almost 60 per cent of the theoretical amount.

Remarks. All chloro derivatives of phenol are converted to chloranil by the above procedure. The process, therefore, offers a possibility for using the by-products of phenol chlorination (page 145) which are often difficult to dispose of because of their poisonous nature and offensive odor.

Two of the chlorine atoms (para to each other) in chloranil are very reactive

⁴⁶ Kempf and Moehrke, Ger. Pat. 256,034 (1913) [*Frdl.*, 11, 193 (1912–1914); *C.A.*, 7, 2096 (1913)].

and are replaceable by various other groups. Thus, reaction with aniline yields 2,5-dianilino-3,6-dichloroquinone:

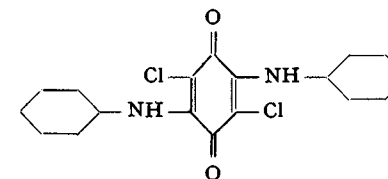

which in itself has the properties of a vat dye for wool, and which is converted by sulfiding into a strong, very stable vat dye.⁴⁷ Chloranil reacts very easily also with sulfur derivatives, such as sodium sulfide, thiosulfate, potassium rhodinate, and others, and the sulfur-containing compounds thus obtained condense with the thiosulfonic acid of dimethyl-*p*-phenylenediamine, for example, to form blue sulfur dyes⁴⁸ (cf. methylene blue, page 311). This reaction is especially interesting in that it takes place stoichiometrically in the cold, just as in the formation of azo dyes.

It is also to be noted that chloranil is often very useful in the laboratory as a mild oxidizing agent, for example, in converting a leuco compound of the triphenylmethane series into the corresponding dye. In this reaction, the chloranil can be used in excess since it does not destroy the dye. Chloranil is too expensive to be used technically for such purposes (cf. page 401).

o- and *p*-Nitrophenols and Their Ethers

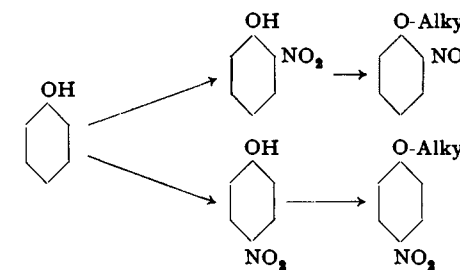

A mixture of 94 grams of melted phenol and 20 cc. water is added dropwise to a solution of 150 grams of sodium nitrate in 400 cc. water and 250 grams of concentrated sulfuric acid. Good stirring is maintained during the addition, and the temperature is kept below 20°C. Stirring is continued for 2 hours. The mother liquor is poured off from the tarry mixture of nitrophenols, and the tar is melted with 500 cc. water with the addition of enough chalk to make the mixture neutral to litmus. The

⁴⁷ M., L., and B., Ger. Pat. 263,382 (1913), 265,195 (1913), 265,196 (1913), 270,401 (1914) [*Frdl.*, 11, 257 ff. (1912–1914); *C.A.*, 8, 257, 429, 2261 (1914)]. R. Lesser, Ger. Pat. 236,074 (1911) [*Frdl.*, 10, 282 (1910–1912); *C.A.*, 6, 2007 (1912)].

⁴⁸ Badische A. und S. F. (Julius and Münch), Ger. Pat. 167,012 (1905) [*Frdl.*, 8, 752 (1905–1907)].

wash water is poured off and the washing repeated. The crude nitrophenols, freed from nitric acid, are subjected to steam distillation, using a condenser with a wide tube. About 40 grams of pure *o*-nitrophenol distills over. The residue in the distillation flask is cooled and filtered after standing for 24 hours. The precipitate is boiled with 1 liter of 2 per cent hydrochloric acid and filtered through a fluted filter. The pure *p*-nitrophenol crystallizes from the filtrate in nearly white, long needles. The extraction can be repeated if necessary.

The yield is about 40 grams each of the ortho and para isomers. It is bad practice to treat the crude nitrophenols with caustic soda, as called for in some procedures, because the caustic has an immediate resinifying action.

Technical Observations. In large scale operations, the distillation is carried out using either coil condensers, surrounded by warm water to prevent stoppage, or ordinary condensers supplied with warm water.

o- and *p*-Nitrophenols are the starting materials for *o*- and *p*-phenetidine and anisidine. *o*-Nitroanisole is used in preparing dianisidine which gives the best direct blues in the trade (diamine pure blue, Chicago blue, and many others).

Alkylation of Nitrophenols

Nitrophenols are converted to their ethers by the general method outlined below.

One mole of the phenol is dissolved in 400 cc. water containing 1 mole of sodium hydroxide and 80 grams of soda ash. To this solution is added 500 cc. 90 per cent alcohol (ethyl or methyl) and the whole is cooled to 10°. Then 1.75 moles of ethyl or methyl chloride is added and the mixture is heated, with stirring or rotating, in an autoclave at 100°C. and 4 to 5 atmospheres pressure for 8 hours. The alkylation is then completed. The mixture is poured into water, and the alkyl ether is separated, recovering the alcohol by rectification. The product, which is washed with small amounts of sodium hydroxide and water, should now contain no nitrophenol.

The following mixture can also be used advantageously, especially for nitro-cresol: 1 mole "phenol," 600 cc. alcohol, 1.8 moles NaOH, 1.7 moles alkyl chloride, no water or soda.

Working with ethyl and methyl chlorides is not easy, and therefore the most suitable techniques should be described briefly. The mixture of nitrophenol, soda, and hydroxide in aqueous alcohol is placed in the autoclave and the latter is closed. It is not necessary that all of the material is dissolved. The autoclave is then evacuated with a water pump and the valve is closed. A small alkyl chloride tube, consisting of a tube

(1) of 2-inch diameter with a screw top (3), is then connected to the autoclave through a copper tube (4) and packing nut (2) (Fig. 25b). The alkyl chloride has previously been poured into the tube, surrounded by ice water, from a cold graduated cylinder. (Methyl chloride is dissolved in an equal weight of cold methyl alcohol, and this solution is placed in the tube.) When the tube is attached to the autoclave, it is inverted (1a) so that the alkyl chloride runs into the connecting tube.

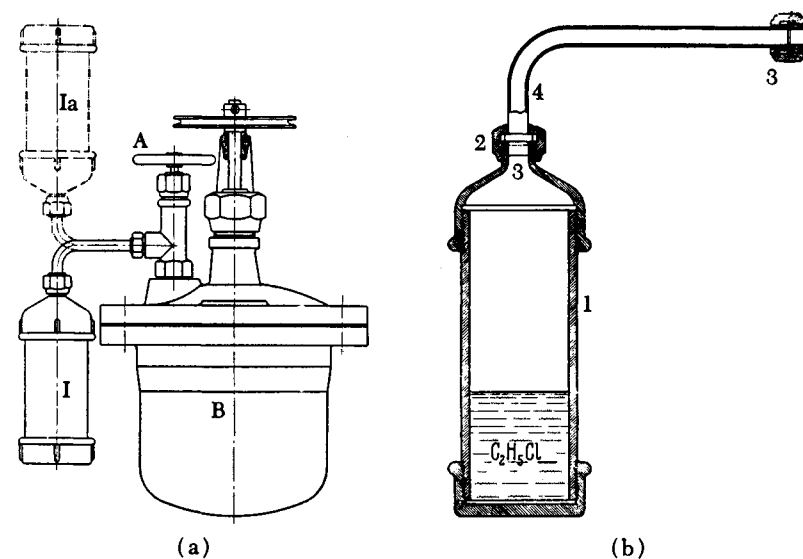

Fig. 25. (a) Method of introducing alkyl chloride into a laboratory autoclave. (b) Auxiliary cylinder (gas pipe) for handling alkyl chlorides.

This connecting tube is warmed with a hot wet towel until it is hot to the touch, and then the valve of the autoclave (A) is opened (Fig. 25a). The hot alkyl chloride is drawn into the autoclave by the vacuum, and the valve is closed after a few seconds. Tests have shown that at least 98 per cent of the alkyl chloride enters the autoclave under these conditions. The alkyl chloride tube, which is not now under pressure, is removed and the autoclave is heated in an oil bath as described above.

In the plant, alkylations are carried out in large horizontal or upright kettles (see chrysophenine). The alkyl chlorides are prepared from hydrochloric acid, zinc chloride (ferric chloride can be used equally well in place of zinc chloride) and alcohol, and are transported in large iron cylinders and stored in reservoirs. For use, the material is trans-

ferred to weighed steel flasks, and pumped or driven by heat from these into the reaction vessel.

The alkyl ethers of *o*- and *p*-nitrophenols can also be prepared from *o*- and *p*-nitrochlorobenzenes by the action of sodium alcoholates (see page 97).

Trinitrophenol (Picric Acid)

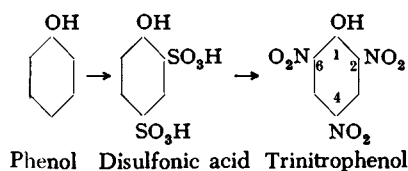

In a glass, iron, or porcelain sulfonation vessel, 94 grams of phenol of the highest quality is heated to 100°C., and 300 grams of 100 per cent sulfuric acid is added with stirring at such a rate that the temperature remains below 110°. The mixture is heated for an hour at 100–110° to complete the sulfonation of the phenol, converting most of it to the disulfonic acid. The mixture is then cooled to 0° in an ice-salt bath, and 3.5 moles of nitric acid, in the form of 50 per cent mixed acid, is added over a period of about 3 hours.

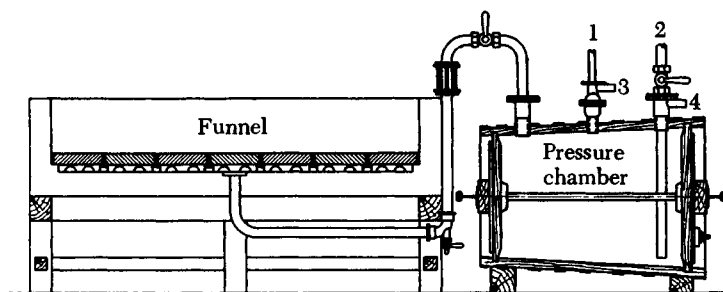

Fig. 26. Stone filter funnel for strongly acid precipitates: (1) vacuum connection; (2) discharge line for removing filtrate; (3) air outlet; (4) connection to wash water, or to the sewer for emptying.

Mixed acid is prepared industrially from very concentrated nitric acid and the most highly concentrated oleum. Ordinarily, nitric acid of sp.gr. 1.48 is mixed in large iron kettles with 40 per cent oleum with cooling by water. This procedure should not be used in the laboratory because of its danger. For laboratory purposes, nitric acid of sp.gr. 1.50 to 1.52 is mixed with an equal weight of 100 per cent sulfuric acid.

After all of the nitric acid has been added, the mixture is allowed to stand overnight at room temperature, then it is warmed very slowly, with stirring, on a water bath at 30° for 1 hour. The temperature is then raised to 45°, but no higher or the mixture may suddenly heat up spontaneously. If this happens, even though an explosion may not occur, the mixture spews out of the kettle. The reaction cannot be completed at 45°, however, so a small portion of the reaction mixture (about 55 cc.) is transferred to a 1.5-liter porcelain beaker and heated on a sand bath to 110–125° with stirring. The rest of the mixture is added dropwise with constant stirring to the preheated portion at such a rate that it

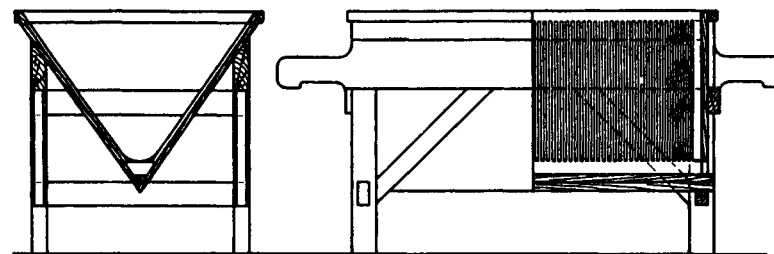

Fig. 27. Portable filter for coarsely crystalline precipitates.

does not foam over. The mixture is heated another 30 minutes at 110–120°, and then sufficient water is added slowly, still at 120°, to make the mixture 40 per cent sulfuric acid (about 700 cc. water is required). Some nitric oxide is generated, but only a small amount if the nitration has been carried out properly. On cooling, the picric acid precipitates quantitatively, since it is insoluble in 40 per cent sulfuric acid. The mother liquor contains some tar and other decomposition products. The product is separated by filtering the cold solution through a cotton filter and washing with cold water. Chemically pure picric acid is obtained in a yield of about 210 grams.

Similar methods are used for preparing Martius yellow (2,4-dinitro-1-naphthol) and naphthol yellow S (1,2-dinitro-4-naphthol-7-sulfonic acid), as well as dinitrocresol and other polynitro compounds. If the concentration of the mixed acid is sufficiently high, the reaction succeeds with nearly the theoretical amount of nitric acid.

Technical Observations. All strongly acid liquids, such as that described above, must be filtered through a material which is resistant to acid. Stoneware funnels (Fig. 26) or filter cloths of nitrocotton (nitro filters) are used in practice. The nitrous fumes generated during the nitration are condensed to form nitric acid in towers filled with Raschig rings.

Picramic Acid

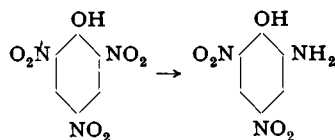

In a glass or iron container of at least 2.5-liter capacity, a solution of 10 grams of picric acid and 10 grams of 35 per cent sodium hydroxide in 600 cc. water is heated to 55°C., and to this is added, with vigorous stirring over a period of 10 minutes, a solution of *crystalline* sodium sulfide in 100 cc. water. When this addition is completed, an additional 127.5 grams of pulverized picric acid is added in teaspoon portions, and simultaneously a solution of 220 grams of sodium sulfide in 400 cc. water is introduced, the additions of the two reagents being completed at the same time (within about 10 minutes in all). If the temperature goes above 65°, ice is added. Stirring is continued for 10 minutes more, then the mixture is poured onto 400 grams of ice, precipitating the sodium picramate completely. After 10 hours, the mixture is filtered, and the precipitate is washed with 10 per cent salt solution. Free picramic acid is obtained by dissolving the sodium salt in 500 cc. water, warming the solution to 80°, and acidifying, with stirring, with dilute sulfuric acid. The mixture, which should be just acid to Congo red, is allowed to cool and stand for 10 hours. The product is then filtered off, yielding about 100 grams of pure material.

Variation. The partial reduction of picric acid can be effected in various ways. Instead of adding the picric acid gradually, and thus using it to neutralize the alkali formed:

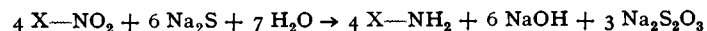

(see also page 114) the sodium salt can be reduced and the necessary amount of hydrochloric acid added simultaneously.

For example, 0.6 mole (137.5 grams) of picric acid is mixed with 1.2 liters of water and 36 grams of soda ash at 50°. Solution is not complete. When the carbon dioxide has been expelled, a solution of 1 mole (240 grams) of crystalline sodium sulfide in 450 cc. water is added, with good stirring, during the course of 30 minutes. Simultaneously, a mixture of 108 grams of 30 per cent hydrochloric acid and 300 cc. water is added at such a rate that this addition requires about 1 minute longer than that of the sodium sulfide solution. Stirring is then continued, with-

out heating, for 30 minutes, and the mixture is filtered after 12 hours. The precipitate is washed with 100 cc. saturated salt solution. This crude sodium picramate is dissolved in 2 liters of water, and the solution is filtered and poured into a hot (90°) solution of 70 cc. 30 per cent hydrochloric acid in 400 cc. water. The pure picramic acid is precipitated completely after 24 hours, and is filtered off, washed with a small amount of water, and dried at 80°. The yield is about 100 grams, or 83 per cent of the theoretical amount.

Of the two procedures given, the first is better suited for large scale work, because the additions of the reagents can be regulated better.

Picramic acid has recently become very important as an azo dye component. Its diazo compound, reacted with unsulfonated couplers, gives very fast chrome dyes for wool, characterized by the fact that they can be used with chromic acid in the dye bath. Examples are the metachrome dyes, e.g., metachrome brown:

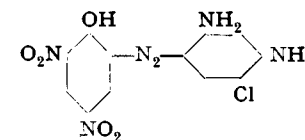

These dyes are generally very difficultly soluble and are often explosive in the dry state. Hence, they must be mixed with a large quantity of Glauber salt or marketed as a paste with water.

The diazo compound of picramic acid was the first diazonium compound discovered and led to the important work of Peter Griess.

2-Aminophenol-4,6-disulfonic Acid from Phenol

(1) *Nitrophenoldisulfonic Acid.* 94 grams of pure phenol is melted at 50° in an iron sulfonation kettle, and 300 grams of 100 per cent sulfuric acid is added to it, with good stirring, over a period of 10 minutes. The mixture is heated to 100°C. for 1 hour, then cooled to 50°, and 300 grams of oleum containing 60 per cent of SO₃ is added. (Only one-half of this quantity of oleum may be used, corresponding to the practice in large scale preparations. It is generally better, in the laboratory, to use the larger amount.) The mixture is again heated at 100° for 1 hour, then cooled in an ice-salt bath to -5°, and a mixture of 100 grams of 65 per cent nitric acid and 100 grams of 100 per cent sulfuric acid is added dropwise, the temperature being kept between -5 and 0°. The nitration requires about 3 hours, and must not be carried out too rapidly or picric acid will be formed. After 10 hours, the reaction mixture is poured into a mixture of 500 grams of ice and 1 liter of water, and the nitrophenoldisulfonic acid is salted out with 300 grams of sodium chloride. The total volume is now about 2 liters. The sodium sulfonate is

precipitated as a light yellow solid which is filtered off after 10 hours and washed on the filter with 200 cc. saturated salt solution. The yield of moist press cake is about 380 to 400 grams.

(2) *Reduction.* The moist press cake is added in small portions during the course of 30 minutes to a hot (100°) solution of 480 grams of crystalline sodium sulfide ($\text{Na}_2\text{S} \cdot 9\text{H}_2\text{O}$) in about 50 cc. water. The temperature rises to about 108°, and the evaporated water is replaced so that the volume is held constant. The reaction mixture first becomes brown, then it turns reddish brown and a crust of reddish crystals is formed. After an hour, the solution becomes lighter in color. It is heated at 105° for 2.5 hours in all, keeping the volume constant. Hydrochloric acid is now added until the mixture shows a definite and permanent acid reaction to Congo red. It is allowed to stand overnight and is then filtered. The precipitate, consisting of sulfur and the aminophenoldisulfonic acid, is boiled with 700 cc. water, and the boiling solution is filtered. The colorless filtrate is treated with 120 grams of potassium chloride and cooled. Even at 90°, the acid potassium salt of aminophenoldisulfonic acid separates practically completely in a colorless form. It is filtered off after 10 hours and pressed out on the filter. The yield is about 230 grams of dry material.

Salicylic Acid from Phenol

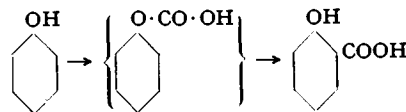

Salicylic acid is prepared today exclusively by the Kolbe-Schmitt method, in which absolutely dry sodium phenolate is treated with dry carbon dioxide, first at ordinary temperature, then at 125° under a pressure of 4 to 7 atmospheres. The reaction proceeds quantitatively if the salt is completely dry and pulverized to a dust. This fine subdivision is achieved by drying and grinding in a vacuum.

In a stirring autoclave, equipped with a valve for the introduction of carbon dioxide, are placed 94 grams of pure phenol and a solution of 1 mole (40.1 grams of 100 per cent material) of carbon dioxide-free sodium hydroxide in about 100 cc. water. (Sodium hydroxide can be completely freed from carbonate by dissolving in an equal weight of water and allowing the solution to stand for 1 day at 50°. It is then filtered through asbestos and titrated, using phenolphthalein as an indicator.) The solu-

tion is evaporated at 100°C. under reduced pressure with constant stirring until no more water is removed. The dry phenolate is then removed from the autoclave and is rapidly pulverized as finely as possible in a previously warmed porcelain dish. It is then immediately returned to the autoclave together with 5 to 10 iron or stone balls of about 14-mm. diameter which serve to pulverize the material still more during stirring in vacuum. The phenolate is heated at 165° in vacuo until it is absolutely dry, which requires 5 to 6 hours. The material is then cooled to 30°, and carbon dioxide is introduced into the apparatus with continuous stirring, adjusting the reducing valve of the cylinder so that the pressure in the autoclave does not exceed 1 atmosphere. After 2 hours, the pressure is slowly increased to 5 atmospheres and the temperature is raised to 125°. After 1 hour more, the introduction tube is removed and the pressure released. After cooling the autoclave, the yellowish, powdery salicylate is dissolved in 400 cc. water and precipitated with 125 grams of 30 per cent hydrochloric acid. Almost pure salicylic acid is precipitated. It is filtered off at 30° and washed with a small amount of water to remove any residual phenol. The product may be purified by distilling with steam superheated to 140°, or by recrystallizing from hot water after precipitating impurities by adding 5 per cent by weight of stannous chloride.⁴⁹ The yield of pure, distilled salicylic acid is as high as 125 grams from 94 grams of phenol.

Technical Observations. The industrial apparatus is fashioned after the laboratory equipment, except that it has a very strong stirring mechanism so that it is not necessary to remove the salt from the autoclave for pulverizing. Special stirring mechanisms are also used for this purpose, having arms operating within one another, making the balls unnecessary. Purification of salicylic acid can also be carried out by sublimation in a stream of hot air, yielding a beautiful product which is, however, not entirely pure. The distilled acid always gives better yields of dyes. In large scale preparations, the yields are almost quantitative, amounting to 137 kilograms of salicylic acid from 94 kilograms of phenol.

o-Cresotinic Acid is obtained in a similar manner from *o*-cresol. In this case, however, the operations must be carried directly through to the end because the sodium salt of *o*-cresol is spontaneously inflammable. About 20 per cent of the *o*-cresol is recovered unchanged, and the *o*-cresotinic acid must be reprecipitated from water. (The material is dissolved in soda, the boiling solution treated with dilute hydrochloric acid, and the product removed by filtering the hot mixture.) In spite of this, *o*-cresotinic acid is not more expensive than salicylic acid, because the poorer yield is offset by the lower cost of *o*-cresol.

Salicylic and cresotinic acids are used in the preparation of azo dyes and of triphenylmethane dyes of the aurine type (eriochrome azurol B). These acids confer upon the dyes the property of going onto metal mordants, particularly chromium mordants, and also of forming complex compounds, in substance, with suitable metal salts. Salicylic acid is also widely used in the pharmaceutical industry.

The Kolbe-Schmitt reaction is also used in the preparation of the technically very important 2-hydroxyl-3-naphthoic acid from β -naphthol.

⁴⁹ Hofmann, Ger. Pat. 65,131 (1892) [*Frdl.*, 3, 826 (1890-1894)].

p-Aminosalicylic Acid

Since salicylic acid is not easily nitrated or nitrosated, *p*-aminosalicylic acid is usually prepared by reduction of the azo dye from diazotized aniline and salicylic acid, according to the following equations:

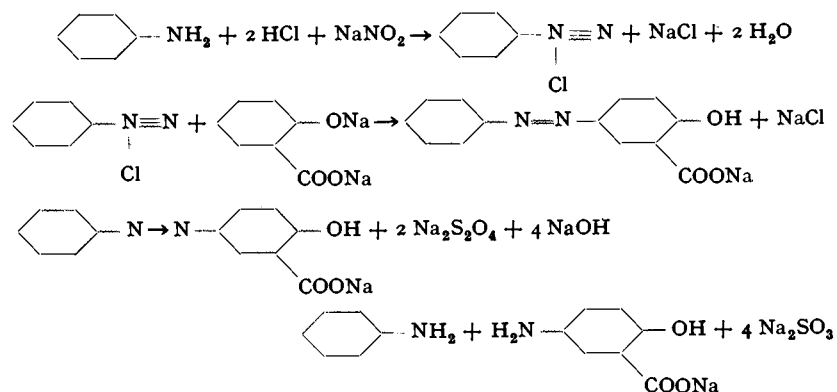
*(a) Preparation of the Azo Dye*

A solution is made of 18.6 grams (0.2 mole) of aniline in a mixture of 45 cc. concentrated hydrochloric acid (21° Bé) and 45 cc. water. The solution is cooled to 0°C. in an ice-salt bath, and a solution of 14 grams of sodium nitrite in 40 cc. water is added slowly with good stirring so that the temperature does not rise above 2°. Stirring is continued for 10 minutes, after which the solution should be strongly acid to Congo red and give a weak test for nitrite with starch-iodide paper. (If the weak nitrite reaction is not obtained, a few more drops of nitrite solution should be added. See page 243.) 4 grams of soda ash is now added carefully to neutralize most of the excess hydrochloric acid, leaving the solution very slightly acid to Congo red. The solution is then added slowly to a stirred, cold solution of 28 grams of salicylic acid (0.2 mole plus 0.4 gram excess) in a mixture of 33 cc. sodium hydroxide solution (40° Bé), 67 cc. water, and 2 grams of soda ash. The temperature is kept below 5° by external cooling. The coupling reaction begins immediately with the formation of a deep yellow color, and at the start, the diazonium compound disappears instantaneously. When about half of the diazo solution has been added, the dye begins to separate and soon a thick, brownish paste is formed. The coupling reaction is now slower, and after all of the diazo solution has been added, stirring must be continued for 5 to 6 hours at 0–5°, until no diazo compound is detectable in the reaction mixture. The dye is almost completely precipitated in finely crystal-

line form and can easily be obtained in a pure state, if desired, by filtering and washing with dilute salt solution. However, the dye need not be isolated for the reduction step which follows.

(b) Reduction

The very thick paste is treated with 80 cc. sodium hydroxide solution (40° Bé), and the mixture is heated to 80°C. to form a clear solution. In the course of 15 minutes 80 grams of powdered sodium hydrosulfite, is added to this solution with stirring at a temperature of 80–90°. (The reduction should be carried out under a hood because of the toxicity of the aniline fumes given off.) The solution becomes lighter in color and is completely decolorized within a few minutes after the addition of the hydrosulfite is completed. Persistence of color after 15 minutes indicates that the hydrosulfite used was not good, and more of it must be added until the solution is colorless. (Water-free sodium hydrosulfite is quite stable in the presence of oxygen as long as it remains completely dry; if moisture is present, the material decomposes rapidly, generating SO₂ and clumping together. Good hydrosulfite should be a free-flowing, odorless powder.) If necessary, additional sodium hydroxide is added to keep the solution strongly alkaline to phenolphthalein at all times. When the reaction is completed, as shown by decolorization, the aniline which is formed is distilled out with steam, heating the distillation flask enough so that constant volume (about 500 cc.) is maintained. When all of the aniline has been removed, the residual solution is filtered through a fluted filter paper and concentrated hydrochloric acid is added *slowly* and with good stirring to the hot filtrate until it shows a faint acid reaction to litmus. This requires about 80 cc. 21° Bé acid for the quantities of materials used here. The aminosalicylic acid separates as a distinctly crystalline, gray-white precipitate. An excess of hydrochloric acid must be avoided or the product will redissolve. An alternate procedure is to neutralize most of the alkali with hydrochloric acid, and the last part with acetic acid. After standing overnight, the product is removed by suction filtration, washed with cold water, and dried at about 80°. The yield is 26 to 28 grams, or 85 to 90 per cent of the theoretical amount. The material dissolves to form clear solutions in dilute hydrochloric acid and in alkali.

Remarks. Salicylic acid is one of the weaker couplers, and it is necessary to work in as concentrated a solution as possible in order to get relatively rapid coupling with it (see page 251). Hence, contrary to older practice, no ice should be added to the reaction mixture, either during diazotization or coupling; external cooling being used instead.

Reduction of azo dyes can be effected with other reducing agents also, e.g., iron and a small amount of acid, or zinc dust and alkali. Hydrosulfite gives the best results, however. Instead of the expensive dry hydrosulfite, one can also use the crude reaction mixture obtained by the action of sulfurous acid on a mixture of zinc dust and sodium hydroxide.

Aminosalicic acid is used in preparing azo dyes, conferring on them, as does salicylic acid, mordant dyeing properties.

11. Derivatives of Toluene

Benzal Chloride and Benzaldehyde from Toluene

(a) Benzal Chloride

In a chlorination apparatus such as that shown in Figure 5 (page 63), 460 grams (5 moles) of toluene containing 10 grams of phosphorous pentachloride is heated to boiling, and chlorine is run in until the gain in weight is 345 grams.

Sunlight or ultraviolet light generally facilitates smooth chlorination of the side chain, especially in the case of chlorotoluenes (see page 162). A 600-1000 watt lamp can be used satisfactorily in the laboratory as the light source.

The chlorination requires about 6 hours. The resulting mixture of unchanged toluene, benzyl chloride, benzal chloride, and benzotrichloride, is distilled through a glass-bead column, and the fraction boiling at 160–225°C. is collected separately. This fraction chiefly contains benzal chloride, boiling at 204°, along with small amounts of benzyl chloride and benzotrichloride. It is possible, particularly on a large scale, to separate the individual compounds by precise fractionation.

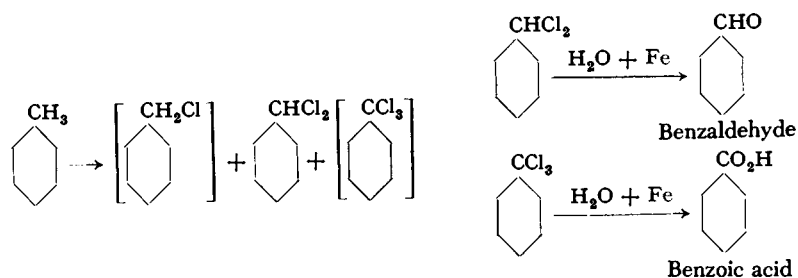

(b) Benzaldehyde

Benzal chloride, used for the preparation of benzaldehyde, should be free from benzyl chloride. It should be fractionated carefully, therefore, removing the portion boiling below 180°.

The benzal chloride (161 grams, 1.0 mole), which may contain some benzotrichloride, is placed in a small glass flask with 0.5 gram of iron powder and heated to 30° with stirring for 30 minutes. 25 grams of water is then added, and the mixture is heated carefully until, at about 100°, generation of hydrogen chloride begins. The reaction then proceeds spontaneously for a time, and is finally brought to completion by gentle heating. Soda is then added in an amount sufficient to make the mixture distinctly alkaline to litmus, and the benzaldehyde is steam distilled out of the reaction mixture. The residue in the distillation flask is filtered, made acid with hydrochloric acid, and cooled to obtain benzoic acid in pure white form. The distillate from the steam distillation contains products, along with the benzaldehyde, which cannot be removed completely by fractional distillation. Therefore, the distillate is treated with technical sodium bisulfite solution, and allowed to stand for some time, after which the oily residue is removed. Depending on the volume of the distillate, 230 to 350 grams of sodium bisulfite solution containing 25 per cent SO₂ is required. Soda or sodium hydroxide is added to the clear liquid to make it distinctly alkaline, and the benzaldehyde is separated in a separatory funnel and distilled at ordinary pressure. The yield of benzoic acid amounts to about 12 grams, that of benzaldehyde to about 80 grams (b.p. 178–179°).

Technical Observations: Toluene cannot be chlorinated in an iron vessel, as benzene can, because, in the presence of iron, the chlorine goes into the ring. It is necessary, therefore, to use glass, enameled, or porcelain apparatus for this chlorination (see also dichlorobenzaldehyde, page 162). The addition of phosphorous pentachloride can often be omitted, since it is not essential but has only an accelerating action. In large scale operations, the hydrolysis of benzal chloride is carried out in a copper apparatus and the separation of the benzaldehyde is made in large lead-lined separating funnels with glass level gauges. The method described above⁵⁰ has entirely replaced the older method starting with benzyl chloride and converting this to benzaldehyde by the action of water and lead nitrate.

There is, however, another process which favors, to a considerable degree, the formation of benzoic acid, a valuable product, and which is also used on a large scale. This method involves the oxidation of toluene in concentrated sulfuric acid by means of pyrolusite or manganite (see xylene blue VS).

Still another method consists in converting toluene to benzyl chloride, hydrolyzing this to benzyl alcohol with aqueous sodium carbonate at 120°, and oxidizing the benzyl alcohol to benzaldehyde by the action of bichromate in 80 per cent sulfuric acid.

Benzaldehyde is used not only as an intermediate for the preparation of various triphenylmethane dyes, but to a still greater extent for perfuming almond oil soaps.

⁵⁰ Schultze, Ger. Pat., 85,493 (1896) [*Frdl.*, 4, 145 (1894–1897)].

The cheaper varieties of these soaps are adulterated with nitrobenzene (oil of mirbane); the adulteration can be recognized by the yellow color of the soap.

2,6-Dichlorobenzaldehyde from *o*-Nitrotoluene

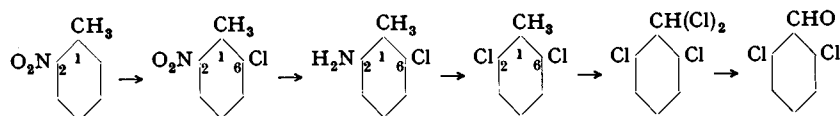

(a) Chloronitrotoluene from *o*-Nitrotoluene⁵¹

Chlorination of *o*-nitrotoluene gives about two-thirds of the 2,6 isomer and one-third of the 2,4-nitrochlorotoluene. 2,4-Dichlorobenzaldehyde, obtained from the latter isomer, yields no valuable dyes, and it is desirable, therefore, to separate the isomeric nitrochlorotoluenes. The separation can be accomplished by careful fractional distillation under reduced pressure.

It is desirable to use, as a chlorination vessel, a relatively tall and narrow glass cylinder (Fig. 5) provided with an inlet tube for chlorine, a thermometer, and a reflux condenser. 5 grams of iron powder and 0.5 gram of iodine are placed in the cylinder, and chlorine is introduced to form iron iodochloride. After a few minutes, 548 grams (4 moles) of thoroughly dry *o*-nitrotoluene is added, and a rapid stream of dry chlorine is started. The iron iodochloride goes into solution after a short time, forming a dark brown solution, and the temperature rises rapidly. The reaction flask should be surrounded by a water bath at 50–60°C. to prevent overheating. The addition of chlorine is interrupted when 95 per cent of the calculated amount (131 grams) has been taken up — usually after about 4 hours. Since large amounts of both chlorine and hydrogen chloride remain in solution in the reaction mixture, they must be removed by evacuation before weighing. The dark-colored reaction mixture is washed thoroughly with dilute hydrochloric acid, then with water, and finally freed from acid by washing with sodium hydroxide solution. The mixture is then fractionated under reduced pressure, using an efficient column having a partial condenser, such as that described on page 342, and regulating the partial condenser to give a reflux ratio of 15 or 20 to 1. Unchanged *o*-nitrotoluene (about 56 to 60 grams) comes over first, then the temperature rises rapidly to 114.6° at a pressure of 11 mm. The first fraction (about 250 grams) is chemically pure 2,6-nitrochlorotoluene (m.p. 37°). Pure 2,4-nitrochlorotoluene (about

⁵¹ Gindraux, *Helv. Chim. Acta*, 12, 927 (1929).

90 grams, m.p. also 37°) can be obtained from subsequent fractions by centrifuging in a porcelain centrifuge. The eutectic mixture (about 260 grams), expelled in the centrifuging operation, can be separated into its constituents by repeated fractionation. In plant processes, it is added to the next batch to be purified.

(b) 2,6-Chlorotoluidine

Nitrochlorotoluene is reduced by the Béchamp method, adding 100 grams of the nitro compound during the course of 2 hours to a boiling, constantly stirred mixture of 100 grams of finely powdered iron, 200 cc. water, and 20 cc. technical hydrochloric acid. 20 grams of soda ash is then added, and the apparatus is heated in an oil bath at 200° while the chlorotoluidine is distilled with superheated steam, the temperature of the steam being 140°C. The base is carried over easily with 3 parts of water at the most, separated in a separatory funnel, and finally purified by vacuum distillation. The boiling point is 105–110° at 10 mm., 240° at atmospheric pressure.

The distillation is not absolutely necessary, but it is advisable to remove all of the iron. The yield is about 94 per cent of the theoretical amount.

(c) 2,6-Dichlorotoluene

A solution is made of 141.5 grams (1.0 mole) of 2,6-chlorotoluidine in 1 liter of water and 450 grams of 30 per cent hydrochloric acid by heating to 80°C. and then cooling to 30° with stirring. Enough ice is then added to lower the temperature to 5°. Some of the hydrochloride crystallizes out. Diazotization is carried out using the equivalent of 70 grams of 100 per cent sodium nitrite dissolved in 200 cc. water (diazotization in general, see page 241 ff.). The temperature should not exceed 16°, and the volume should be about 1.4 liters. The diazotization is considered complete when a reaction with starch-iodide paper persists after 10 minutes. The diazonium solution is added, during the course of 30 minutes, to a cuprous chloride solution prepared by adding sulfurous acid to a solution of 200 grams of copper sulfate and 200 grams of salt in 800 cc. water and removing the excess SO₂ by boiling.

Cuprous chloride solution can also be prepared in the following way: 100 grams of copper sulfate is dissolved in 500 cc. water, and 50 grams of zinc dust is added to precipitate all the copper. The supernatant liquid is poured off and the copper treated with dilute hydrochloric acid to dissolve out all the zinc. 100 grams

of salt is added, then a solution of 100 grams of copper sulfate, and the mixture is heated at 80° for 15 minutes.

Alternatively, a hydrochloric acid solution of cupric chloride is boiled under reflux with waste copper (e.g., turnings) until it is decolorized, and the resulting solution is poured off from the excess copper.

The cuprous chloride solution is best heated in a glazed crock by running in steam, and the diazonium solution is run in with mechanical stirring. In order to prevent loss of dichlorotoluene, the crock must be well covered and the temperature should not exceed 95°. The mixture is transferred to a 4-liter flask and the dichlorotoluene steam distilled out. The material coming over weighs about 141 grams, or 88 per cent of the theoretical amount. This product is not sufficiently pure. It is washed in a separatory funnel with 5 per cent of its weight of sulfuric acid (66° Bé), then with water, and finally twice with 40 per cent sodium hydroxide solution. The material is then distilled. It boils at 185–192°.

(d) 2,6-Dichlorobenzal Chloride

The laboratory chlorination of dichlorotoluene to form dichlorobenzal chloride is very simple. Chlorine is passed into boiling, dry dichlorotoluene, in sunlight if possible, until the original weight of 161 grams has increased 69 grams. With these quantities, the chlorination is easily completed in 2 hours. The reaction flask must be equipped with an efficient reflux condenser so that the hydrogen chloride generated does not carry out entrained benzal chloride. The product is distilled under reduced pressure, giving about 1 per cent boiling at 116–119° at 16 mm., about 95 per cent of the dichlorobenzal chloride boiling at 120–130°, and a residue of higher chlorination products and tar. 2,6-Dichlorobenzal chloride boils at 250° at atmospheric pressure.

(e) 2,6-Dichlorobenzaldehyde

Hydrolysis of 2,6-dichlorobenzal chloride is much more difficult than that of benzal chloride itself. In contrast to the latter, 2,6-dichlorobenzal chloride is not hydrolyzed either by water and iron or by calcium or potassium hydroxide, even under pressure at 150°C. The hydrolysis to the desired aldehyde is effected with concentrated sulfuric acid, although a considerable portion of the product is resinified in the process.

A mixture of 100 grams of 2,6-dichlorobenzal chloride and 200 grams of 66° Bé sulfuric acid is stirred for 12 hours at 55°. The mixture is then diluted with 1 liter of water, and the product is separated from the dilute

sulfuric acid and distilled with steam. About 30 grams of pure 2,6-dichlorobenzaldehyde, melting at 71°, is obtained.

Technical Observations. 2,6-Dichlorobenzaldehyde has become a rather important intermediate in recent years, as it is the starting material in the preparation of several dyes of the aurine series (eriochrome azurol, etc.). It is of technical interest also because its preparation involves three types of chlorination reactions. The first two of these offer little difficulty even in large scale preparations, but the third is not easy to accomplish. The latter suffers from the inadequacy of large glass apparatus; containers of copper, tin, etc., cannot be used and enamel cracks at the high temperatures which are necessary. Pyrex or porcelain containers are used, therefore, heated with superheated steam or by means of sand baths. Gas heating can also be used. When glass containers are used, steam heating affords protection from fires, but the pressure is so high in the steam heated pipes (200 atmospheres) that bursting may occur. For these reasons, the simple sand bath is still used to a large extent.

Traces of iron (from factory dust) or of antimony (from rubber stoppers or tubing) may prevent chlorination in the side chain.

The preparation of 2,6-dichlorotoluene is one of the few examples of the technical use of the Sandmeyer reaction. This method was once used in the preparation of *o*-chlorotoluene (for subsequent conversion to *o*-chlorobenzaldehyde) from *o*-toluidine. Another process⁵² for preparing *o*-chlorotoluene makes use of the following reactions:

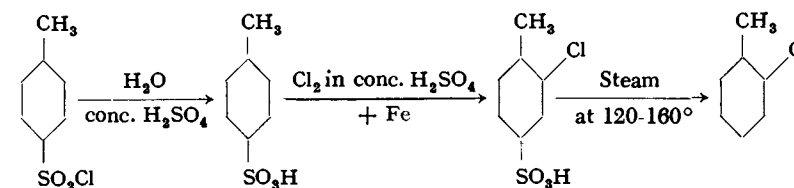

The first step involves hydrolysis, with concentrated sulfuric acid, of *p*-toluenesulfonyl chloride, which is quite cheap. The resulting sulfonic acid is chlorinated smoothly in the position ortho to the $-\text{CH}_3$ group, the reaction being carried out in sulfuric acid solution using iron as a catalyst. Finally, the sulfo group is split out with steam, yielding the desired *o*-chlorotoluene in excellent yield. This process is less satisfactory for use in the laboratory, but gives the best results in industrial operations.

The chlorine atom in *o*-chlorobenzaldehyde is easily replaceable by a sulfo group by heating the chloro compound with neutral sulfite at 150°C. Ortho sulfonated benzaldehyde give alkali fast triphenylmethane dyes (patent blue, erioglaucine, xylene blue).

In large scale operations, distillation at the intermediate stages is omitted, except that the dichlorotoluene must be distilled to make it completely dry. With the other compounds, it suffices to separate them from the mother liquors in leaded separatory funnels. The copper solutions are always reconverted to cuprous chloride by treatment with zinc dust or iron, and the loss involved in this recovery seldom exceeds 2 per cent.

⁵² Badische A. und S. F., Ger. Pat. 294,638 (1916) [*Frdl.*, 12, 908 (1914–1916); *C.A.*, 11, 2582 (1917)].

2,6-Chloronitrotoluene and 2,6-chlorotoluidine are technically important in other respects also. The former compound is the starting material for the preparation of 4,4'-dichloroindigo, which yields, on further chlorination or bromination, the very greenish 4,5,4',5'-tetrahalogenindigos (e.g., brilliant indigo 4G). 2,6-Chlorotoluidine, as fast scarlet TR base, is used in generating ice colors (naphthol AS). The isomeric 4-chloro-2-toluidine (fast red KB base), prepared by reduction of the by-product 4-chloro-2-nitrotoluene, is used for the same purpose.

Benzidine-3,3'-dicarboxylic Acid from *o*-Nitrotoluene

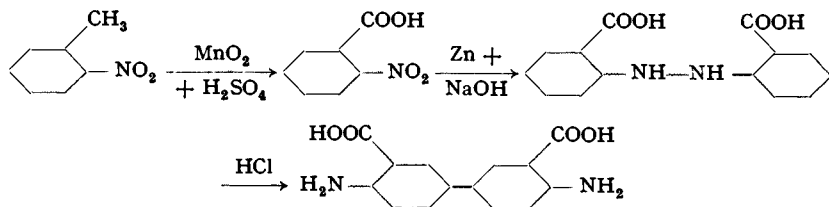

A solution is made of 33.4 grams (0.2 mole) of pure *o*-nitrotoluic acid⁵³ in 120 cc. sodium hydroxide solution (40° Bé) and 40 cc. water, by heating to 100°C. Zinc dust is added to this solution, in small portions with vigorous stirring, at such a rate that the temperature of the solution stays at 100–105° without external heating, continuing the addition until the originally deep yellowish brown solution is completely decolorized. About 40–50 grams of zinc dust is required, depending on its quality, and the addition requires about 15 minutes. As soon as the solution becomes colorless, 600 cc. hot water is added, and the excess zinc dust is filtered off and washed with hot water. The filtrate is treated with 20 cc. 2 *N* acetic acid and a few drops of bisulfite solution (to prevent oxidation), and then 140 cc. 21° Bé hydrochloric acid is added dropwise with good stirring. At this point, the solution should be strongly acid to litmus, but not to Congo red, so that rearrangement does not occur. (The acetic acid added earlier facilitates attainment of the correct acidity.) A filtered test portion of the solution should give no precipitate on addition of acetic acid, and additional acid is added if necessary. The solution is then cooled and the hydrazobenzoic acid, which separates in a crystalline, easily filterable form, is filtered off with suction and washed thoroughly with cold water. The pale brownish yellow filter cake, weighing about 50 grams, is stirred with 80 cc. water to form a uniform paste; 60 cc. 21° Bé hydrochloric acid is added, and

⁵³ Obtained from *o*-nitrotoluene by oxidation with manganese dioxide and sulfuric acid: Badische A. und S. F., Ger. Pat. 179,589 (1906) [*Frdl.*, 8, 151 (1905–1907)]; C.A., 1, 1506 (1907)].

the mixture is heated at 95–100° for 30 minutes, maintaining the volume by addition of water. When the material has all dissolved except for a small black residue, the resulting solution is filtered hot and the residue washed with a hot mixture of 15 cc. concentrated hydrochloric acid and 30 cc. water. The violet colored filtrate is again heated to 70–80° and neutralized, with stirring, with ammonia (50 to 60 cc. 25 per cent solution) to the point where the acid reaction to Congo red disappears. The precipitation is then completed by the addition of a solution of 30 grams of crystalline sodium acetate in 70 cc. water. A filtered test portion should give no further precipitate with either acetic acid or sodium acetate. The precipitated benzidinedicarboxylic acid is filtered from the warm solution, washed thoroughly with warm water, and dried in a steam heated drying oven. The yield is about 26 grams of pale greenish gray product, or about 92 per cent of the theoretical amount.

An especially pure, pale yellowish green product can be obtained by cooling the acidic filtrate following the rearrangement reaction. The bulk of the material separates as the hydrochloride. This is filtered off and stirred with hot water, and converted to the free benzidinedicarboxylic acid by the addition of sodium acetate. The mother liquor remaining after filtering off the hydrochloride is treated according to the above procedure for recovering the rest of the product.

Technical Observations. Tetrazotized benzidinedicarboxylic acid gives, with 2 moles of 1,8-aminonaphthol-2,4-disulfonic acid (Chicago acid, see page 217), a disazo dye which, in the form of its copper compound on viscose silk, gives a bright blue shade having extraordinary light fastness.

2-Nitro-4-aminotoluene from *p*-Toluidine

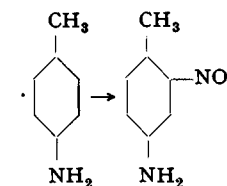

p-Toluidine (53.5 grams, 0.5 mole) is added with stirring to 1000 grams of concentrated sulfuric acid (66° Bé), at such a rate that the temperature rises to about 40°C. but not appreciably higher. Rapid solution occurs under these conditions. The solution is cooled in an ice-salt bath (see page 131) to –5°, and a mixture of 34 grams of 93 per cent nitric acid, *free from nitric oxide*, and 66 grams of concentrated sulfuric acid (66° Bé) is added slowly, keeping the temperature below 0°. If nitric acid or mixed acid free from nitric oxide is not available, it

can be prepared by passing a stream of *dry* air through concentrated nitric acid at 40–50° until the acid is completely colorless. The acid is then cooled while air is being passed through, and a test sample is titrated with sodium hydroxide to determine its acid strength. The amount of the acid containing 31.5 grams of HNO₃ is weighed out and to it is added, slowly and with cooling, exactly twice its weight of concentrated sulfuric acid. Care must also be taken, of course, that the sulfuric acid used in dissolving the toluidine, as well as in preparing the mixed acid, is free from SO₂, because otherwise nitrous acid or nitrosylsulfuric acid will be formed in the reaction mixture.

After the addition of the nitrating acid, the reaction mixture is stirred at 0° for 5 to 6 hours and then tested (nitrometer) to establish that all of the nitric acid has been used. If the test is satisfactory, the mixture is poured, with stirring, onto 2.5 kilograms of ice. The difficultly soluble sulfate of 2-nitro-4-aminotoluene separates as reddish crystals which are filtered off with suction after a short time, pressed out well, and washed with cold water to remove adhering acid. The precipitate is then dissolved in boiling water, and the solution is filtered to remove a small amount of tarry residue, then made alkaline, while still warm, with ammonia. The mixture is thoroughly cooled, and the orange yellow crystalline base is filtered off, washed with cold water, and dried at room temperature. The yield is 60 to 62 grams, or about 80 per cent of the theoretical amount. The product melts at 76–77°.

An additional amount of the product can be obtained by neutralizing the sulfuric acid mother liquor with ammonia. It is recommended that the mother liquor be neutralized just to a point where it is still faintly acid to Congo red. On cooling the hot solution, a few grams of nitroaminotoluene sulfate separates, mixed with some tar. This is filtered off and converted to the free base. The filtrate is then made alkaline by the addition of more ammonia, precipitating several grams of the free base. These second and third fractions melt only about one degree lower than the main fraction. Together, they total about 7 to 8 grams, or 10 per cent, so that the total yield is about 90 per cent of the theoretical amount.

General Remarks. Primary aromatic amines, whose basic properties are not too strongly reduced by the presence of negative substituents, can often be nitrated smoothly without protecting the amino group by acetylation or the like. The nitration is carried out in the presence of a large amount (at least 10 parts) of concentrated sulfuric acid and at as low a temperature as possible, below 0° in any case. The nitric acid must be entirely free from HNO₂.

Under these conditions, the orienting influence of the amino group is almost completely masked and the other substituents which are present determine the position taken by the nitro group. Thus, in compounds in which the position para to the amino group is occupied by a halogen atom, or by an alkyl, aryl, or alkoxy group, the nitro group almost exclusively enters the position ortho to these substituents and meta to the amino group. This is the case, for example, with *p*-toluidine,

p-anisidine, *p*-phenetidine, and *p*-chloroaniline, as well as with diamines such as benzidine, 4,4'-diaminodiphenylmethane, etc. If the amine to be nitrated has one of the above mentioned substituents in the position ortho to the amino group, then the nitro group predominantly enters the position para to the amino group, and, to a smaller extent, the other free ortho position. For example, *o*-toluidine yields chiefly 4-nitro-2-aminotoluene along with a small amount of 6-nitro-2-aminotoluene; *o*-anisidine gives chiefly 4-nitro-2-aminoanisole, etc. These rules of orientation hold also for the nitration of secondary or tertiary amines in the presence of much concentrated sulfuric acid.

Only rarely is the sulfate of the nitrated base so insoluble that it separates directly on dilution of the reaction mixture as in the above example. In many cases, the hydrochloride can be precipitated by the addition of salt. Frequently, however, it is necessary to neutralize the entire amount of sulfuric acid in order to isolate the product, but this cannot be done with lime because then calcium sulfate would be precipitated with the base. In industrial preparations, the neutralization is done with magnesia, of which only a small amount is required because of its low equivalent weight, or with ammonia. In the latter case, the filtrate is treated with lime and the ammonia is recovered and used again. It is preferable to carry out the neutralization in steps, because most of the impurities are precipitated first, and the later fractions are pure.

Dinitrostilbenedisulfonic Acid and Diaminostilbenedisulfonic Acid from *p*-Nitrotoluene (Simultaneous Oxidation of Two Molecules)

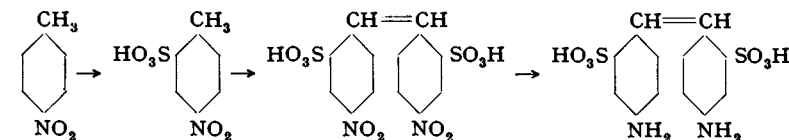

(a) Dinitrostilbenedisulfonic Acid

100 grams of *p*-nitrotoluene is sulfonated exactly like nitrobenzene (page 120), and the product is isolated as the sodium salt. The press cake is dissolved at 50°C. in a solution of soda ash in 500 cc. water. About 50 grams of soda ash is required, provided that the material has been pressed out adequately. The solution is filtered to remove some iron oxide which is almost always present, and diluted to 2 liters.

The solution is heated to 50° in a water bath, the apparatus being arranged to prevent local overheating by placing the reaction flask in the water bath on a cloth pad, thus permitting uniform heat transfer. Over a period of 30 minutes, 160 grams of 35 per cent sodium hydroxide is added to the stirred solution, during which none of the sodium sulfonate should precipitate. A mixture of about 1700 grams of 5 per cent sodium hypochlorite solution and 300 grams of 35 per cent sodium hydroxide is then added slowly over a 3-hour period. The strength of the hypochlorite is first determined accurately by titration with As₂O₃, and the quantity of solution corresponding to 85 grams of NaOCl is used. It must be remembered that hypochlorite solutions are stable only if they contain at least 5 per cent excess

NaOH; this fact is especially important in the preparation of hypochlorite solutions. The temperature should not be allowed to rise above 60° or yellow dyes of the Mikado series are formed. The mixture is allowed to stand at least 4 hours at 55°, during which time it should give a positive test for active chlorine with starch-iodide paper. The solution is then cooled to 15° and allowed to stand for a day after 400 grams of salt has been added. Sodium dinitrostilbenedisulfonate separates as a yellow, crystalline precipitate, and this is filtered off and washed with a small volume of salt solution.

The yield of the crude salt is about 100 grams.

(b) Reduction to Diaminostilbenedisulfonic Acid

The difficultly soluble sodium salt from the first step is dissolved in 300 cc. hot water, and the free sodium hydroxide present is neutralized with dilute hydrochloric acid. The resulting solution is added during the course of 30 minutes to 200 grams of iron turnings which have been etched with 20 cc. 40 per cent acetic acid. The reduction then proceeds in the normal way (see, e.g., page 75).

When reduction is complete, the reaction mixture is neutralized with soda, filtered to remove the iron sludge, and made strongly acid to Congo red with hydrochloric acid, precipitating diaminostilbenedisulfonic acid as a yellowish, finely crystalline material. After 10 hours, the product is filtered off and washed thoroughly.

The yield is about 70 grams of 100 per cent material from 100 grams of *p*-nitrotoluene. This compound cannot be diazotized satisfactorily by the indirect method, in contrast to the analogous benzidine-2,2'-disulfonic acid.

Technical Observations. The preparation given here for diaminostilbenedisulfonic acid was first described by Green. With the decrease in the cost of chlorine, it has completely replaced the Leonhardt method which involves the reduction of Mikado yellow, formed by the action of concentrated sodium hydroxide solution on *p*-nitrotoluenesulfonic acid. At the best, this older method gave only about 48 per cent of the theoretical yield, and the reduction required large amounts of zinc dust or ammonium sulfide. Also the product from the Green synthesis is much purer if the reaction mixture is not too concentrated, the product contains almost no diaminodibenzylsulfonic acid, which appreciably impairs the preparation of chrysofenine. The presence of the dibenzyl compound in the product can be detected easily by either of two reactions. The first test depends on the fact that the dye from H acid and the dibenzyl acid is much more red than that from H acid and the stilbene derivative. The second test is based on the fact that the "chrysofenine" from the dibenzyl derivative is not a pure blue, but almost red violet, in the presence of mineral acid. The presence of a relatively small proportion of the dibenzyl compound can be recognized immediately by a comparison test with pure diaminostilbenedisulfonic acid.

Oxidation of the dinitro acid is carried out in concrete tanks. It should be pointed out that a small amount of iron or copper decomposes the hypochlorite solution immediately, and for this reason, wooden tanks cannot be used.

2-Chloro-5-aminobenzoic Acid

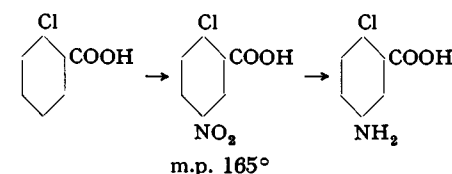

For this reaction, one can use the *o*-chlorobenzoic acid obtained in the preparation of *o*-chlorobenzaldehyde. Before using the technical acid, it should, in all cases, be dissolved in dilute sodium hydroxide and reprecipitated after filtering the alkaline solution.

A solution is made by stirring 32 grams of pure *o*-chlorobenzoic acid with 160 grams of 100 per cent sulfuric acid in a porcelain or iron container, and then cooled to below 0°C. in an ice-salt bath. A mixture of 16 grams of 80 per cent nitric acid and 40 grams of 100 per cent sulfuric acid is added dropwise over a period of about 1 hour, keeping the temperature below 0° to prevent the formation of undesired by-products. Near the end of the reaction, part of the nitro compound separates. The mixture is held at room temperature for 10 to 12 hours, and then heated slowly to 60°, after which it is poured onto 400 grams of ice. The nitrochlorobenzoic acid is filtered off and preferably recrystallized twice from 1 liter of boiling water to remove unchanged chlorobenzoic acid. This purification is omitted in industry, but is to be recommended in laboratory preparations. A pure product is obtained in this way in a yield of about 37.5 grams, or 92 per cent of the theoretical amount. The material melts at 164–165°.

For the reduction, 20.2 grams (0.1 mole) of chloronitrobenzoic acid is dissolved in 70 cc. water containing 5.5 grams of soda ash. The solution is then acidified by the addition of 10 cc. 40 per cent acetic acid and is added dropwise to a boiling suspension of 100 grams of zinc dust in 250 cc. water to which 4 cc. 40 per cent acetic acid has been added. The mixture is boiled and stirred continuously, and since bad foaming is often encountered, a large reaction vessel should be used (3-liter enameled crock).

The reduction takes about 2 hours, after which 5 grams of soda ash is added and the solution is filtered. The filtrate, after evaporation to 200 cc., can be used directly for the preparation of azo dyes without isolating the chloroaminobenzoic acid. The yield, determined by titration, is about 92 per cent of the theoretical amount.

If it is desired to isolate the chloroaminobenzoic acid as such, the solution is acidified with hydrochloric acid, avoiding an excess.

12. Gallamide and Gallic Acid from Tannin

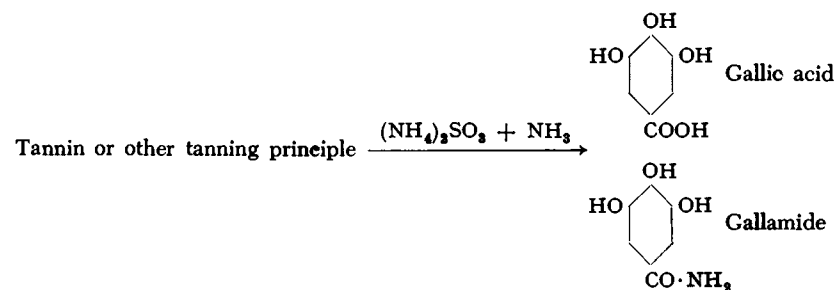

The most important starting materials for the preparation of gallamide and gallic acid are gallnuts and sumac (*Rhus coriaria*). The tannins from these are split either into sugar and gallic acid by the action of sodium hydroxide, or into sugar, gallamide, and gallic acid by the action of ammonium sulfite. In the latter case, about equal parts of the amide and the acid are obtained.

200 grams of the tannin, 200 cc. water, 400 grams of 20 per cent ammonia, and 100 grams of sodium bisulfite solution (25 per cent SO_2) are heated for 12 hours at 50° (water bath) in a pressure bottle with a rubber stopper. The mixture must be shaken from time to time in order to get complete solution. The resulting solution is transferred to a large glass flask and concentrated to 400 cc. under reduced pressure.

After the residue has cooled, hydrochloric acid is added until the solution is just faintly acid to litmus. The gallamide separates completely in the course of 24 hours. (In laboratory preparations, it is often necessary to cool a small portion of the solution and scratch the container in order to start the crystallization.) The product is filtered off and washed well with water. To the mother liquor is added 100 grams of 30 per cent sodium hydroxide and ammonia is removed in vacuum. The solution is then concentrated to 300 cc. and enough concentrated hydrochloric acid is added to make the solution just acid to Congo red. The sodium salt of gallic acid separates, in the course of a few days, as a finely crystalline precipitate which is filtered off and pressed out without washing. The sodium salt is dissolved in 100 cc. water and gallic acid is precipitated from the solution by the addition of hydrochloric acid. About 60 grams each of gallamide and gallic acid are obtained.

Technical Observations. Large scale preparations use tannin solutions which are obtained by countercurrent extraction of the tannin-containing material with

hot water. The extracts are concentrated in vacuum to 30° Bé. The hydrolysis of the tannin is carried out in huge concrete vats, adaptable to work under either reduced or increased pressure. Crystallization of the gallamide requires 10 to 14 days, that of the gallate even longer. Tannin solutions have a strong tendency to ferment, and must be worked up rapidly, especially during the summer. The purity of the gallamide is determined by distilling a weighed sample with sodium hydroxide, collecting the ammonia in 1 N hydrochloric acid, and back-titrating. A good grade of gallamide is 92 per cent pure.

Gallamide and gallic acid are used in large quantities for the preparation of oxazines (see gallamine blue).

13. Benzene Derivatives from Naphthalene

Phthalic Anhydride from Naphthalene by Catalytic Oxidation⁵⁴

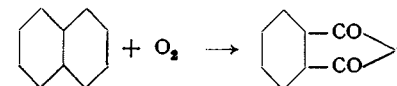

The heat of combustion of naphthalene is +1234 kilocalories per mole, and of phthalic anhydride, +450 kilocalories per mole.

The catalytic oxidation of naphthalene can easily be carried out in the laboratory, although the amount of phthalic anhydride which can be prepared in one operation is insignificant. It is of great importance that the correct temperature be maintained and that a suitable catalyst be used. Special attention must be given to the apparatus if the preparation in the laboratory is to succeed. Furthermore, it is highly desirable to use a Cottrell precipitator to collect the reaction product completely. This apparatus will collect even the fine particles, which otherwise would be lost.

Preparation of the Catalyst

Pumice is broken up into pieces about 3 mm. in size and screened, using a sieve that retains the 3-mm. pieces. The more uniform the pieces are, the better. This pumice is placed in a hot solution of ammonium vanadate which is as concentrated as possible. When the pumice is thoroughly impregnated, it is removed from the solution and dried in a porcelain dish on a water bath. About 3 grams of vanadium are taken up by 200 grams of pumice. The dried mass is now heated to 400°C . until the grains have a reddish brown color. It is important that the

⁵⁴ Wohl, Ger. Pat. 347,610 (1921) and 379,822 (1923) [*Frdl.*, 14, 836, 450 (1921-1925)]. See also Chowdhury and Choudhury, *J. Indian Chem. Soc.*, 11, 185 (1934), and Chowdhury and Saboor, *ibid.*, 14, 638 (1937).

catalyst is not heated above the temperature at which it is to be used later, a precaution to be observed in many catalytic reactions.

Rule: A catalyst should not be heated above the reaction temperature.

Performing the Reaction. Apparatus

The diagram in Figure 28 best explains the procedure. Naphthalene is placed in flask B, which is heated to 110°C., and a stream of moist air is passed through the gas introduction tube (A). The presence of water vapor is important for the oxidation. The necessary air is most

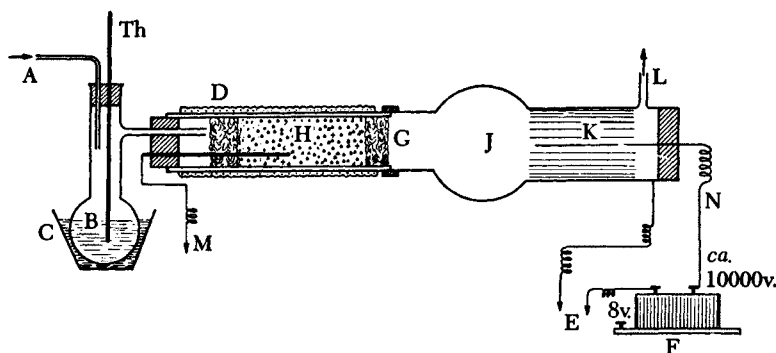

Fig. 28. Apparatus for preparation of phthalic anhydride by catalytic oxidation: A, air inlet tube; B, melted naphthalene; C, graphite bath; D, electrical heating element; E, ground; F, spark induction coil; G, glass wool; H, catalyst; J, bulb receiver; K, aluminum foil, grounded; L, gas exit tube; M, thermocouple; N, rigid wire; Th, thermometer. One side of the spark induction coil is connected to N, the other is grounded.

simply supplied by a water pump which is readily available in the laboratory, and the quantity of air passed through the apparatus is measured with regular laboratory equipment which need not be described here. The air stream should be regulated so that 200 liters of air and 5 grams of naphthalene are passed through the apparatus in 1 hour. It is important that the ratio of air to naphthalene be controlled so that an explosive mixture is not formed, since this would cause a loss of phthalic anhydride. The mixed gases (air and naphthalene vapor) are passed into the catalyst tube, which should be of about 5-cm. internal diameter and should contain a charge of catalyst about 10 cm. in length. The pumice particles are held in place by glass wool. Heating of the catalyst is done electrically as is the usual practice in technical laboratories.

The gases coming from the catalyst are passed first into a round receiver (J), and then go to the precipitator. The latter consists of a glass tube of about 8-cm. internal diameter, the inside wall of which is lined with a smooth aluminum foil which can be removed easily and which is well grounded through a metal wire to a water pipe. A wire or silvered glass rod projects into the tube, and to this a potential of 10,000 volts is applied. This potential, which can be alternating for the present purpose, is generated in the usual manner, most simply by an induction coil or a transformer with interrupter. It is important that the air spark length of the induction coil be at least 25 mm. The internal width of the tube carrying the precipitator must therefore be sufficiently great so that sparks do not jump from the wire to the metal foil. Such sparking may cause explosions which, although not involving danger, may easily burn part of the reaction product.

When the apparatus, to which careful attention must be given, is assembled correctly, the oxidation can be started. The catalyst tube is heated to 450°C. (thermocouple), and the stream of mixed air and naphthalene vapor is started. The oxidation takes place as the vapors pass through the catalyst. Part of the phthalic anhydride collects in the bulb receiver, but most of it is collected in the Cottrel precipitator where it frequently forms beautiful needles, up to 5 cm. in length, in a small space at the extreme first part of the precipitator. The operation can be continued as long as desired, since the catalyst retains its activity for weeks provided that pure naphthalene is used. The yield of phthalic anhydride is about 90 to 95 per cent of the theoretical amount, the product being chemically pure if the oxidation temperature is maintained at the correct point and the throughput is not too high. If too much naphthalene is put through per unit of time, the product becomes yellowish due to admixed 1,4-naphthoquinone. The product is removed from time to time by drawing out the aluminum foil. 20 grams of pure phthalic anhydride can easily be prepared in 5 hours in the laboratory.

Phthalimide from Phthalic Anhydride

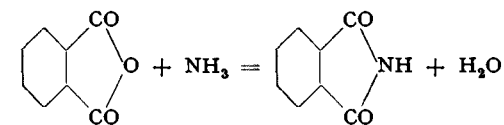

In a three-necked flask fitted with thermometer, gas introduction tube, and *wide* outlet tube bent downward, 148 grams (1.0 mole) of pure phthalic anhydride is melted and heated to about 170°. At this

temperature a rapid stream of ammonia is passed into the molten anhydride. The ammonia is completely absorbed and steam escapes, carrying with it some phthalic anhydride. Sublimed material which condenses in the neck of the flask is melted down from time to time. During the introduction of the ammonia, the temperature is raised slowly until it reaches 240°. At this point, the phthalimide does not solidify since its melting point is 230°. When ammonia begins to escape, the reaction is nearly complete. The stream of ammonia is continued for 10 minutes more, and the melt is immediately poured into a porcelain dish where it is allowed to solidify. About 130 to 135 grams of phthalimide is obtained, melting at 223° (uncorrected) and containing as an impurity only traces of unchanged phthalic anhydride.

Anthranilic Acid from Phthalimide

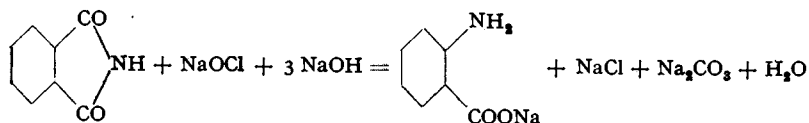

A solution is made by stirring 73.5 grams (0.5 mole) of finely powdered phthalimide with 250 cc. water and 125 grams of ice and then adding 55 cc. sodium hydroxide solution (40° Bé). As soon as solution is complete, 250 grams of ice is added and then, in one portion, a chlorate-free sodium hypochlorite solution, which corresponds to 37 grams of active chlorine and contains two moles of NaOH for each mole of NaOCl.* An additional 20 cc. 40° Bé sodium hydroxide solution is added just before use. A drop of the reaction mixture added to a few drops of aniline water should give only a very weak violet coloration. After the solution is thoroughly mixed, it is allowed to stand in an ice bath for 3 to 4 hours, and then a few drops of bisulfite solution are added to destroy the small excess of hypochlorite. The solution is then heated to 80° and neutralized at this temperature with concentrated hydrochloric acid (foaming) just to the point where litmus paper is not turned blue (about 130 cc. acid). The hot solution is filtered to remove any inorganic impurities, and the filtrate is acidified by adding 40 cc. concentrated hydrochloric acid and 12 cc. glacial acetic acid. (An

* The hypochlorite solution is easily prepared by adding 71 grams of chlorine to a mixture of 400 cc. sodium hydroxide solution (40° Bé) and 400 grams of ice, cooled in an ice bath. The concentration of active chlorine is determined iodometrically. Commercial hypochlorite solutions, which have been held for a long time, contain appreciable amounts of chlorate and are not suitable for the present purpose.

excess of hydrochloric acid must be avoided, since it would dissolve the anthranilic acid.) Anthranilic acid begins to separate from the hot solution as a crystalline, light brown precipitate becoming more copious on cooling. After standing overnight, the product is filtered off, washed with cold water, and dried in a steam heated drying oven. The yield of anthranilic acid melting at 144–145° is 57 to 58 grams, or about 84 per cent of the theoretical amount.

The anthranilic acid remaining in solution in the filtrate can be recovered by adding copper acetate to form the insoluble copper salt. This salt is filtered off, suspended in water, and decomposed by passing in hydrogen sulfide. The copper sulfide is filtered off and the filtrate is concentrated to a small volume. When the resulting solution is cooled, a few grams of anthranilic acid crystallize out.

B. COMPOUNDS OF THE NAPHTHALENE SERIES

In the preparation of naphthalene derivatives, good yields are obtained only if the naphthalene used as the starting material is of the highest purity. If a good grade of naphthalene is not at hand, it is recommended that the material be purified, first by distillation, and then by treating it with 5 per cent of its weight of concentrated sulfuric acid. Generally, however, pure naphthalene from tar distillation is available today.

14. α -Nitronaphthalene and α -Naphthylamine⁵⁵

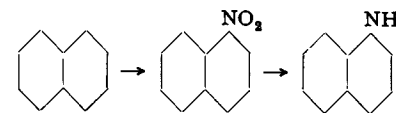

In general, naphthalene reacts much more easily than benzene; and nitration of naphthalene takes place so energetically that polynitro compounds are formed easily. On the other hand, since the reaction is carried out at a temperature below the melting point of naphthalene, the larger particles may not be attacked by the nitric acid under the

⁵⁵ See also O. N. Witt, *Chem. Ind. Ger. Nachr.-Ausgabe*, 10, 215 (1887); L. Paul, *Z. angew. Chem.*, 10, 145 (1897).

conditions employed. Hence, it is necessary to pulverize the naphthalene to such a degree that it will pass through a sieve having 400 meshes per square centimeter.

Naphthalene crystallized as plates is very difficult to pulverize. If such material is to be used, it should first be melted and allowed to solidify in a compact crystalline mass which is much more easily pulverized.

To a mixture of 103 grams of 62 per cent nitric acid (40° Bé) and 300 grams of 80 per cent sulfuric acid, 128 grams of naphthalene is added. The mixture is stirred continuously for 6 hours at 50°C., and then the temperature is raised to 60° during the course of 1 hour. On cooling the mixture, the nitronaphthalene floats as a porous cake on the surface of the acid. It contains about 90 to 92 per cent of the α -nitro compound, 4 to 5 per cent of the β -nitronaphthalene, 2 to 3 per cent of dinitronaphthalene, and about 0.5 per cent of 2,4-dinitro-1-naphthol (Martius yellow).

The crude product is melted several times with boiling water to remove the acid and simultaneously distill out any residual naphthalene. The melted product is then poured into cold, well stirred water, causing it to solidify in the form of small balls.

If purified nitronaphthalene is desired, the crude material is dried by melting at 120° in an air oven. It is then treated with 10 per cent of its weight of ligroin (b.p. about 150°). (Commercial xylene or cumene can also be used.) The solution is filtered hot through a smooth filter and allowed to stand for some time. The resulting cake of crystals is pressed out strongly in a cotton cloth. The purification operation is repeated until the nitronaphthalene has a melting point of 61°. It is then in the form of yellow, glistening crystals. Part of the product is lost in the mother liquors and can be recovered by distilling off the solvent.

The crude nitronaphthalene is reduced by the Béchamp method using iron and a small amount of hydrochloric acid. In an iron reduction vessel equipped with an anchor-type stirrer (Fig. 11) is placed 200 grams of iron turnings, 100 cc. water, and 10 cc. concentrated hydrochloric acid (30 per cent). The mixture is heated in a boiling water bath, and the nitronaphthalene is added in small portions, preferably in the manner described for the reduction of *p*-chloro-*o*-nitrophenol (page 110). With continuous stirring, 173 grams (1.0 mole) of nitronaphthalene (air-dried material) is reduced in a period of 4 hours. It is not advisable to operate more rapidly or undesired azo compounds may be formed. The mixture is now made distinctly alkaline by the addition of soda and removed from the reduction vessel. The α -naphthylamine can be separated most satisfactorily in the laboratory by distillation with superheated steam. For this purpose, the whole reaction mixture is transferred to a kettle such as that shown in Figure 29. The

water is completely driven off, while the mixture is being stirred, by heating the oil bath to about 200°, and then steam, superheated to 250°, is passed in (Fig. 23a). (The figure shows a schematic apparatus without stirrer. Stirring is recommended, however, in order to make the separation of iron oxide and naphthylamine easier.) A rapid distillation will easily carry over one-half to one part of naphthylamine with

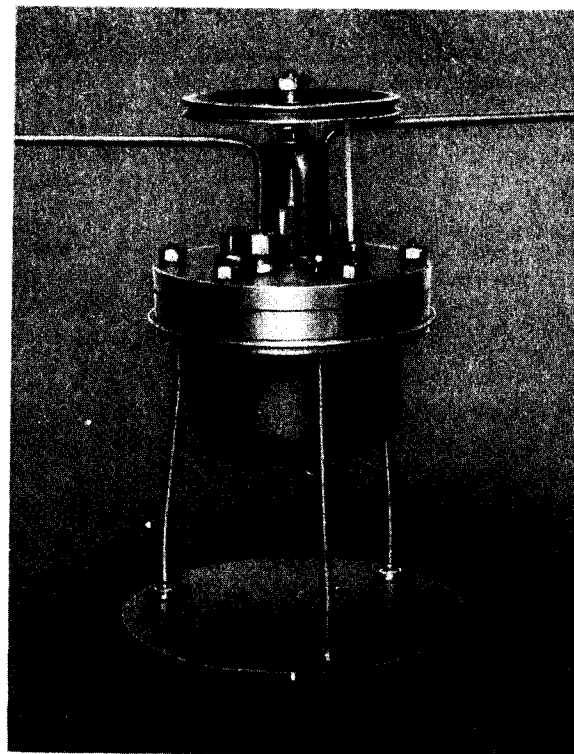

Fig. 29. Cast iron reaction kettle with stirrer for use at pressures up to 2 atm.; weight, 12 kg. The oil bath is made of copper.

one part of water. A small amount of very finely divided iron powder, graphite from the cast iron, and iron oxide always comes over with the base. The distillation is complete when no more product, or only colored material, comes over with a steam temperature of 260°. The whole distillation requires 1 to 1.5 hours, depending on the type of heating employed. The kettle then contains a very fine, black mass which is pyrophoric and which therefore cannot simply be thrown out. The naphthylamine is separated from the mother liquor after cooling,

melted, and dried at 110° in an air oven. Vacuum distillation of the dried product gives the base as a colorless, crystalline material. The yield from 1 mole of naphthalene is about 110 grams of pure α -naphthylamine melting at 50°.

The reaction mixture can also be worked up in the following way. When the reduction is complete, the mixture is neutralized with soda and all of the water is evaporated under vacuum. The residue is then extracted three times with benzene, and the extract is distilled at atmospheric pressure to remove the benzene. The α -naphthylamine is then distilled under reduced pressure.

Technical Observations. (a) *Nitronaphthalene.* The waste acid from the nitration is always partly re-used, being brought back to 80 per cent sulfuric acid by the addition of stronger acid. The unused part of the acid is used in acidifying alkali fusion mixtures, and similar purposes. The nitration is almost quantitative if the starting material has been ground up correctly (disintegrating at 60°). Nitronaphthalene is used in the preparation of 1,5- and 1,8-dinitronaphthalenes, as well as of the diazo compound of 1-amino-2-naphthol-4-sulfonic acid. In the latter preparation, nitronaphthalene, heated with bisulfite, gives 1-naphthylamine-2,4-disulfonic acid along with some naphthionic acid. The disulfonic acid is diazotized and converted to the diazo compound of 1-amino-2-naphthol-4-sulfonic acid by treatment with sodium bicarbonate and sodium hypochlorite. This remarkable series of reactions is shown below:⁵⁶

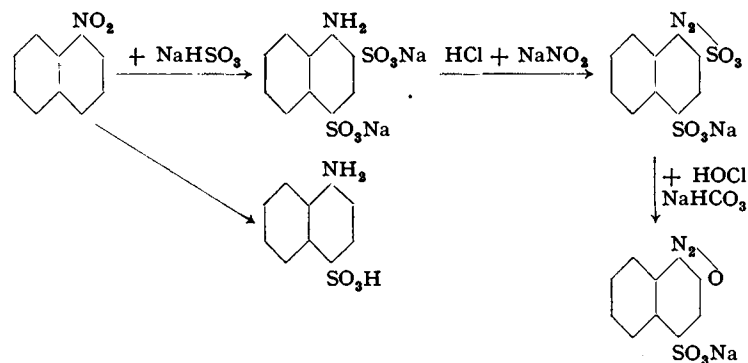

This process, although good, has been replaced by the less expensive Sandmeyer process (page 202).

(b) *α -Naphthylamine.* The reduction is carried out in apparatus similar to that already described. However, paddle or propeller stirrers cannot be used because of the pasty consistency of the reaction mixture, and only anchor-type stirrers are usable, such as the one shown in Figure 31. The steam distillation is done in apparatus such as the one shown in Figure 24, in which the steam is heated in a superheater. Various satisfactory models of this equipment are supplied by different manufacturers.

In large scale operations, a large part of the naphthylamine can be drawn off directly as a liquid. The residue of iron, iron oxide, and α -naphthylamine is mixed with sawdust and extracted several times with benzene. The mixture of

⁵⁶ Badische A. und S. F. Ger. Pat. 160,536 (1905), 157,325 (1904), 156,440 (1904) [*Frld.*, 8, 656-7 (1905-1907)].

iron, iron oxide, and sawdust is freed of benzene by steam and then sent to the foundry where it is used as a binding material for briquetting of iron turnings for the cupola furnace.

α -Naphthylamine is used as an end component or especially as a middle component, in the preparation of many important azo dyes; it is also used in the preparation of dyes of other classes. α -Naphthylamine is the starting material for the synthesis of a whole series of dye intermediates, some of which are described below. Like aniline, α -naphthylamine has found a new and interesting application outside of the dye field. It is used in North America and Australia in refining some of the poorer ores by the flotation process. In this process, the finely stamped ore is mixed vigorously (emulsified) with about one-half of one per cent of its weight of naphthylamine and crude xylene and a large quantity of water. The heavy ore, despite its high specific gravity, collects with the foam on the surface and can easily be scooped off.

Phenyl- α -naphthylamine

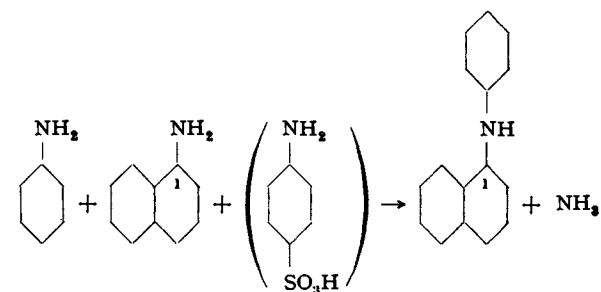

In a round-bottomed flask fitted with a thermometer and a vertical tube, a mixture of 143 grams (1.0 mole) of α -naphthylamine, 175 grams of aniline, and 3 grams of sulfanilic acid is boiled vigorously for 42 hours. Ammonia is liberated and the boiling point of the mixture increases to 215°C. from an initial value of about 195°. When the reaction is completed, the mixture is fractionated carefully in vacuum. Three fractions are taken: about 80 grams of aniline, about 10 grams of an intermediate fraction containing some aniline, a little α -naphthylamine, and mainly phenyl- α -naphthylamine, and finally, 190 to 200 grams of phenyl- α -naphthylamine which solidifies at about 53°. The residue is worthless and is discarded. This method, which is generally used today, gives a purer product than is obtained when the condensation is carried out with hydrochloric acid. Little or no diphenylamine is formed, and the reaction can be carried out on a large scale in an iron vessel. At 12 mm. pressure, the boiling point of aniline is about 73°, of α -naphthylamine about 160°, and of phenyl- α -naphthylamine about 224°.

Phenyl- α -naphthylamine, as well as the alkyl derivatives of α -naphthylamine, is used in preparing basic diphenyl-naphthylmethane dyes (Victoria blue).

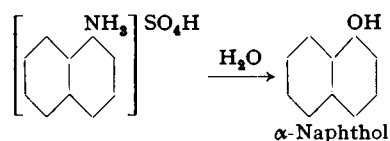
α -Naphthol from α -Naphthylamine

A mixture of 143 grams of α -naphthylamine, 110 grams of 66° Bé sulfuric acid, and 1 liter of water is heated at 200°C. under 14 atmospheres pressure. The naphthylamine should first be melted in the water and the acid added in a thin stream with good stirring. The autoclave should be either leaded or enameled, although the cover can be of iron, since the sulfuric acid is not volatile. It is necessary that the autoclave be heated in an oil bath, because any overheating might cause the lead to melt.

After 8 hours, the mixture is allowed to cool and the α -naphthol is separated from the mother liquor. Ammonium sulfate is recovered from the latter. The product is melted with a little water and, after cooling, separated from the liquid. It is almost chemically pure. Completely pure material is obtained by vacuum distillation. The yield of α -naphthol melting at 94° is 94 to 95 per cent of the theoretical amount.

Technical Observations. The process described above is the best and least expensive. There is, however, another method which is analogous to the preparation of β -naphthol. Sodium naphthalene- α -sulfonate is fused with caustic soda at 290° (not to exceed 300°). The sulfonation is carried out at 80–90°, and the product is salted out in as concentrated a solution as possible. The sulfonate can also be isolated by removing the excess acid with lime or chalk, treating with soda, and evaporating to obtain the product. The sulfonate, thus obtained, can be used in the fusion without further purification, but the resulting α -naphthol is impure.

Naphthionic Acid from α -Naphthylamine

Naphthionic acid is prepared from naphthylamine acid sulfate by the baking process, i.e., long, dry heating, preferably under reduced pressure.

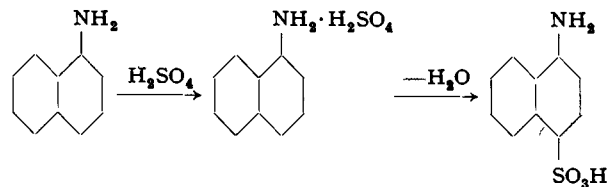
**(a) Preparation of the Acid Sulfate**

In a three-neck flask fitted with thermometer, stirrer, and vertical condenser, 73.5 grams of 70 per cent sulfuric acid is heated to 120–125°,

and then a warm (50°) solution of 75 grams of α -naphthylamine in about 15 grams of benzene is added with thorough stirring, during a 30-minute period. The formation of clumps of undissolved base is completely avoided in this way, and the benzene distills out slowly. The light reddish solution soon solidifies, and the resulting solid is dried at 120° in vacuo for 18 hours. A very pure acid sulfate, which is of the greatest importance in the baking process, is obtained by the use of 70 per cent sulfuric acid and pure α -naphthylamine.

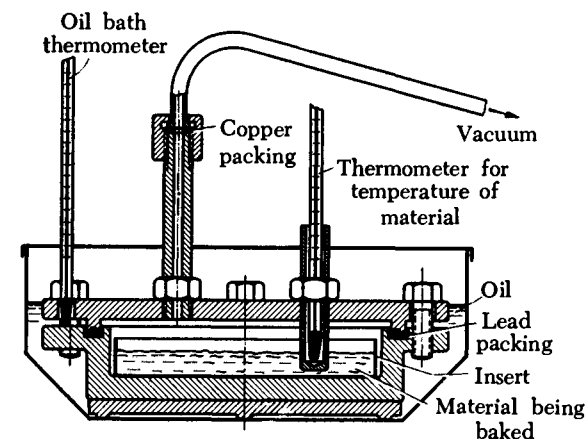

Fig. 30. Vacuum baking apparatus.

(b) Baking Process

The conversion of α -naphthylamine sulfate into naphthionic acid is carried out in a vacuum baking apparatus constructed as shown in Figure 30. 75 grams of the finely powdered sulfate is heated for 8 hours at 180° under a pressure of 10–15 mm. After the heating a light gray mass remains. This is dissolved in about 500 cc. water to which 20 grams of anhydrous soda has been added. The solution is heated to boiling and filtered, and then extracted with benzene to remove unchanged naphthylamine. The solution is again heated to boiling and hydrochloric acid is added until a slight turbidity is formed. Decolorizing carbon is added, the solution is filtered hot, and the filtrate is cooled and acidified with hydrochloric acid. The colorless naphthionic acid which separates is filtered off and dried at 100°. The yield is 60 to 65 grams, or 85 to 95 per cent of the theoretical amount.

The general principles of the baking process are discussed on page 127 ff.

1-Naphthol-4-sulfonic Acid (Nevile-Winther Acid) from
Naphthionic Acid (Bucherer Reaction)

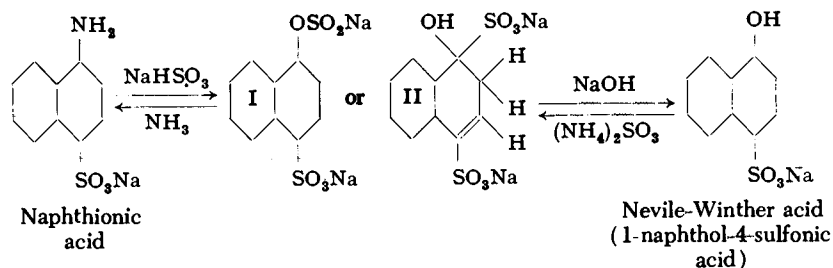

A mixture of 100 grams of 100 per cent naphthionate in 200 cc. water and 600 grams of sodium bisulfite solution (25 per cent SO_2) is boiled under reflux for 1 day. Sufficient 30 per cent sodium hydroxide solution is then added to cause the solution to give a red test with thiazole paper, and the solution is boiled as long as ammonia is liberated, then acidified with hydrochloric acid. Crystalline Nevile-Winther acid is obtained on cooling. It is freed from residual naphthionic acid by dissolving in water and filtering. The yield is about 80 per cent of the theoretical amount.

Naphthols as well as naphthylamines are converted to labile intermediate compounds by the action of bisulfite. These intermediates were considered to be sulfurous acid esters of naphthols (Formula I) by Bucherer, the discoverer of the reaction, but Woroshtzow formulated them as addition products of bisulfite with the keto forms of the naphthols (Formula II). These intermediates yield the corresponding naphthylamines with ammonia, and are hydrolyzed to the naphthols by caustic alkali. Thus, it is possible to convert naphthols into naphthylamines (pages 200 and 203), as well as naphthylamines into naphthols.⁵⁷

Furthermore, ammonia can be replaced by primary or secondary aliphatic or aromatic amines (the latter, however, only in the β series), thus affording a means of preparing alkylated or arylated naphthylamines starting with either the primary naphthylamine or the corresponding naphthol.⁵⁸

The Bucherer reaction is also applicable with certain compounds in the benzene and anthracene⁵⁹ series, but it is of practical significance only with naphthalene compounds. The reaction can be used with both α - and β -naphthols or

⁵⁷ Bayer & Co., Ger. Pat. 109,102 (1899) [*Frdl.*, 5, 164 (1897-1900)]. Badische A. und S. F., Ger. Pat. 115,335 (1900), 117,471 (1900), and 126,136 (1901), [*Frdl.*, 6, 187-190 (1900-1902)].

⁵⁸ Badische A. und S. F., Ger. Pat. 121,683 (1901) and 122,570 (1901) [*Frdl.*, 6, 192-194 (1900-1902)].

⁵⁹ I.C. (Limpach and Hager), Ger. Pat. 550,707 (1930) [*Frdl.*, 19, 1899 (1934); *C.A.*, 26, 4962 (1932)]. *Helv. Chim. Acta*, 29, 1756 (1946).

-naphthylamines. It does not work, however, if a sulfo group is present in the position ortho or meta to an α -OH or —NH_2 , or meta to a β -OH or —NH_2 . Thus, for example, in J acid (2-amino-5-naphthol-7-sulfonic acid) or Gamma acid (2-amino-8-naphthol-6-sulfonic acid), the reaction involves only the amino group and not the hydroxyl group which is "protected" by the meta sulfo group (cf. phenyl-gamma acid, page 209). Similarly, the reaction with 2,8-dihydroxynaphthalene-6-sulfonic acid involves only the hydroxyl group in the 2 position (page 208).

1-Naphthol-4-sulfonic acid can be prepared also by diazotizing naphthionic acid. It is used chiefly as an azo dye component.

15. The Sulfonic Acids of Naphthalene

The naphthalenesulfonic acids find very little direct use in the preparation of dyes, but they are of great technical importance as steps in the preparation of important intermediates such as β -naphthol and β -naphthylamine, dihydroxynaphthalenes and aminonaphthols, and numerous naphthylamine-, naphthol-, and aminonaphthol-sulfonic acids.

As was pointed out in the section on orientation rules, the position in the naphthalene nucleus taken by an entering sulfo group depends on the sulfonation temperature. The α position is favored at low temperatures, the β position at higher temperatures. Accordingly, sulfonation to produce the α -sulfonic acid is carried out at as low a temperature as possible, at least below the melting point of naphthalene, and the naphthalene must be used in a finely pulverized form (see also the preparation of 1,5- and 1,8-naphthylaminesulfonic acids, page 214). The preparation of the β -sulfonic acid, on the other hand, is carried out at the highest temperature possible without causing decomposition, about 160-170°C. Even under these conditions, some of the α -isomer is always formed, the amount being at least 15 per cent according to the results of various experimenters. The complications involved in this sulfonation have been cleared up largely by the work of O. N. Witt.⁶⁰

The procedure to be followed usually varies, depending on whether the naphthalene- β -sulfonic acid is to be isolated as such or nitrated or sulfonated without actual isolation. In the latter case, since an excess of sulfuric acid must be used anyway, the procedure of Witt⁶⁰ is advantageous and is used widely in industry. In this process, an excess of sulfuric acid is used in the sulfonation for the purpose of converting the α -sulfonic acid into the disulfonic acid as completely as possible, since the α -compound is further sulfonated much more easily than the β -sulfonic acid. On the other hand, when the β -sulfonic acid must be isolated as such, cost considerations demand that the minimum amount of sulfuric acid be used (see β -naphthol, page 187).

⁶⁰ Witt, *Ber.*, 48, 743 (1915).

1,6- and 1,7-Naphthylaminesulfonic Acids (Cleve Acids)

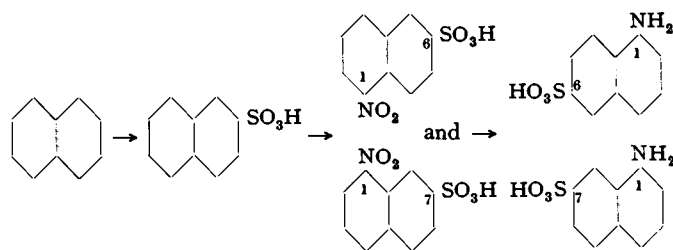

The 1,6- and 1,7-naphthylaminesulfonic acids have long been very important as components for azo dyes, particularly as the middle component in polyazo dyes. They are used in the preparation of the important black cotton dyes of the type of Columbia black FF, and also of a whole series of developed dyes, such as the important naphthogene blue, Zambesi black V, and others. Sulfonic acids of this type are also frequently used in preparing dyes of the Sirius blue series (Bayer).

The sulfonation is best accomplished according to Witt's procedure, as described in the following paragraphs.

In a sulfonation and nitration vessel as described on page 101 (Fig. 19), 128 grams of naphthalene of the highest quality is heated over a free flame to 165°C. with continuous stirring. This temperature is maintained while 206 grams of 94 per cent sulfuric acid (66° Bé) is run in slowly. The addition should be made over a period of at least 30 minutes, or too much of the α acid is formed and the yield is lowered. The mixture is then heated for 30 minutes at 165° in order to convert as much as possible of the α acid into the disulfonic acid so that the final product contains the 1,6 and 1,7 acids, practically free from isomeric α -sulfonic acids. The mixture is allowed to cool to 60° while being stirred, but external cooling is not applied since this causes the formation of a precipitate adhering to the walls of the vessel. If such a precipitate does form, it must be scraped from the walls, and if necessary, from the stirrer, and broken up. When the temperature has dropped to 60°, the reaction mixture is diluted with 300 grams of 90 per cent sulfuric acid. (In industrial processes, the monosulfonic acid at this stage is forced by air pressure over into the nitrating vessel. The diluting acid is added first, and it is important that the mixture is not cooled too much since separation of the β -sulfonic acid may occur under some conditions causing the mixture to solidify and clog the tube.) The mixture is now cooled further with continuous stirring, and when the temperature has dropped to 25°, *very slow*, dropwise addition of 103 grams (1.0 mole)

of 62 per cent nitric acid (40° Bé) is started. Since the nitro compound formed is much more soluble in sulfuric acid than is the naphthalene-sulfonic acid, there is no longer any danger of the reaction mixture solidifying after the nitration has been started. Therefore, the reaction mixture is cooled in ice to 10° after a few grams of nitric acid has been added, and the nitration is completed at this temperature. When about half of the nitric acid has been added, the mixture is examined to see that no deposit has formed on the walls of the vessel and no large lumps are present. If present, these aggregates must be broken up since solid crusts or thick lumps of crystallized naphthalenesulfonic acid will resist nitration even on very long standing. Similar precautions must be taken in processes which use less sulfuric acid for reasons of economy and in which, therefore, the danger of solidification is still greater. When all of the nitric acid has been added (about 2.5 hours), the mixture is allowed to stand for at least 12 hours, after which a nitrometer test should show the presence of not more than about 2 per cent of the nitric acid used. The viscous, but clear, brownish solution is poured into 2 liters water. Practically no nitrous acid should be generated.

The resulting acid solution is heated to 75° and a 20 per cent solution of ferrous sulfate is added until no more nitric oxide is formed. A stream of air is then blown through the liquid until a drop of the solution, greatly diluted with water, fails to give an *immediate* blue coloration on starch-iodide paper. It is essential that these conditions be met, otherwise side reactions occur in the subsequent reduction.

The ferric salts formed from the ferrous sulfate also give a reaction with starch-iodide paper, but the coloration appears only after one or two seconds, and then it begins to form *around the edge* of the test drop. An experienced person will not mistake the two reactions; it is safer, however, for the beginner to use, instead of starch-iodide paper, the so-called "sulfone reagent" (4,4'-diaminodiphenylmethane-2,2'-sulfone) which does not react with ferric salts and which is not destroyed by the strong acid. For further details, see page 243, in the section on the diazotization of aniline.

The reaction mixture is now treated with 50 grams of magnesium carbonate, and then with enough finely powdered chalk (about 320 grams) to neutralize all of the free sulfuric acid. (Slaked lime can also be used, but care must be taken not to make the mixture strongly alkaline because free alkali or alkaline earth hydroxide decomposes the nitrosulfonic acids.) The thick paste of calcium sulfate is filtered on a large suction funnel, and the residue is pressed out thoroughly and washed repeatedly with hot water until the washings are only slightly yellow in color. Complete washing out is not to be recommended because the volume of wash water required is too large; the total volume of filtrate and washings should be about 2.8 liters.

Reduction. The solution of the nitrosulfonic acids is made slightly but distinctly acid to Congo red by the addition of hydrochloric acid. In a 2.5-liter reduction beaker, preferably of copper, are placed 250 grams of finely powdered gray cast iron (see pages 75 and 77) and 250 cc. water. The mixture is heated to boiling and the iron is etched by the addition of 10 cc. glacial acetic acid. After boiling for a short time, 20 grams of crystalline sodium acetate is added and then the weakly acid solution of the nitrosulfonic acids is added, over a period of 1 hour, while the mixture is boiled and stirred vigorously (the iron must be churned up!). A considerable part of the solution evaporates but the total volume should not decrease to less than 1 liter. When the addition is completed, boiling is continued for 20 minutes, and then a test is made to see whether a drop of the solution is nearly colorless on filter paper. It will not be completely colorless, but it should, in no case, be strongly brown or yellow. The boiling solution is neutralized by the addition of calcined magnesia (about 20 grams) until a test drop on filter paper shows the presence of an easily filterable iron oxide precipitate and the solution is weakly, but distinctly, alkaline to litmus. The solution should also be tested on filter paper with sodium or ammonium sulfide to determine whether all of the iron has been precipitated. If this is not the case, the residual iron is precipitated with a small amount of ammonium sulfide. It is absolutely necessary to remove the last traces of iron to avoid rapid oxidation of the Cleve acids in subsequent steps.

The solution of the magnesium salts of Cleve acids is filtered with suction and the solution evaporated, if necessary, to 1 liter, using a porcelain dish over a free flame and a wooden propeller over the dish.

The concentrated solution is made strongly acid to Congo red by the addition of about 100 cc. concentrated hydrochloric acid and left to crystallize for a day while being stirred continuously. Both of the Cleve acids (1,6- and 1,7-naphthylaminesulfonic acids) separate slowly, although they are rather insoluble in water once they have precipitated. After 24 hours, the precipitate is filtered off and washed thoroughly with a large volume of water.

To separate the crude acids, the precipitate is dissolved in 800 cc. hot water and enough ammonia (or soda solution) is added to make the solution distinctly alkaline. Sodium chloride is now added in sufficient amount to make the solution 10 per cent with respect to salt. The difficultly soluble salt of the 1,7 acid separates in the course of a day in the form of greasy, lustrous, yellowish plates which are filtered off and washed with 10 per cent salt solution and then with a small

amount of cold water. Hydrochloric acid is added to the filtrate to make it distinctly acid to Congo red, and the solution is allowed to stand with occasional stirring for 2 days. The resulting precipitate of the 1,6 Cleve acid is filtered off, washed with water, and dried at 100°.

The yield of 1,6 Cleve acid is about 80 grams (mol.wt. 223), that of 1,7 Cleve acid about 75 grams of the sodium salt (mol.wt. 245).

The mother liquor contains appreciable quantities of the impure products which are discarded or, in large scale operations, recovered by evaporation.

Technical Observations. The pure 1,6- and 1,7-naphthylaminesulfonic acids give practically identical dyes. Frequently it is advantageous to use a mixture of the two acids because the resulting dyes are stronger, particularly in the case of black polyazo dyes (e.g., Columbia black or Zambesi black V).

The 1,7 Cleve acid is usually obtained in higher purity than is the 1,6 acid, so the 1,7 acid is generally used in preparing complex dyes. The presence of 1,8-naphthylaminesulfonic acid in the 1,7 Cleve acid is easily recognized by diazotization, and heating the diazonium compound. The 1,8 compound yields naphthsultone, which forms an insoluble precipitate which can be filtered off and weighed (see page 217).

Naphthalene- β -sulfonic Acid and β -Naphthol

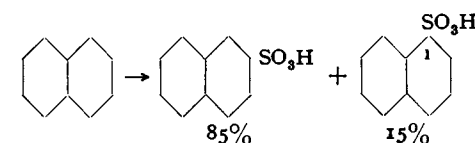

In the preparation of naphthalene- β -sulfonic acid, the sulfuric acid must be used up very completely since β -naphthol is so cheap that only the cheapest process for its preparation will survive.

In the apparatus described on page 101, 256 grams (2 moles) of naphthalene is heated to 165°C. over a free flame with continuous stirring, and over a period of 30 minutes 280 grams of 94 per cent sulfuric acid (66° Bé) is added, while the temperature is held between 163 and 168° by careful regulation of the flame. The dropping funnel is now removed and in its place is installed a bent glass tube fitted tightly into the cover (with a cork or asbestos paper). During the course of the sulfonation, water and naphthalene distill out through this tube. The mixture of naphthalene and sulfuric acid is heated with continued stirring for an hour at 165°, then an hour at 167°, another hour at 170°, and finally an hour at 173°. During this time, about 30 grams of water and 25 grams of naphthalene are collected in the receiver. An appreciable amount of naphthalene deposits on the cover of the reaction flask, but this is neglected. The flame is now removed and the apparatus dismantled. The resulting mixture contains, in addition to naphtha-

lenesulfonic acid, a certain amount of sulfone, free sulfuric acid, and some disulfonic acid, along with tars. It should be almost colorless. The mixture is poured, still hot, into 1.8 liters water.

The resulting solution of the free sulfonic acid is partly neutralized by the careful addition, with good stirring, of 60 grams of soda ash. Then, 360 grams of salt is added slowly. The solution soon solidifies in large lumps which make further stirring difficult. Nevertheless, stirring must be continued until the mixture appears completely homogeneous, for only in this way can an easily filterable precipitate be obtained and complete solution of the salt be achieved. The duration of stirring depends on its speed, but should be at least 6 hours to ensure complete separation. The precipitate is then filtered off on a large suction funnel with a cotton filter, sucked as dry as possible, then transferred to a moistened, strong, cotton cloth and pressed out in a screw press, carefully at first and then as strongly as possible. The pressing should be carried on for at least 2 hours, otherwise too much mother liquor remains in the precipitate. The resulting hard mass is broken up and dried completely at 100–120°.

The yield of "β salt" is about 165 per cent calculated on the basis of naphthalene, or about 400 to 420 grams. From the mother liquor, containing some of the α acid in addition to tar and a trace of β acid, Glauber salt may be recovered.

Alkali fusion of sodium naphthalenesulfonate is one of the most important organic-technical operations. With the low price of naphthol, it is not surprising that only a few manufacturers undertake the preparation. Very cheap materials, such as coal, soda, and sulfuric acid, are essential.

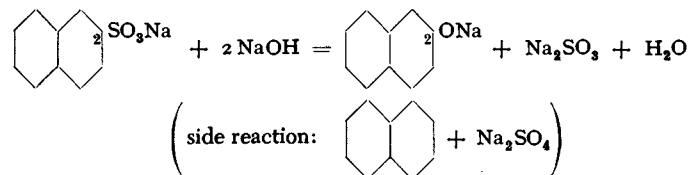

The sodium sulfonate must be pulverized very finely in order to get good fusion with the alkali. In the laboratory, this is accomplished most easily by grinding the salt in a coffee grinder.

The fusion apparatus described on page 87 (Fig. 14) is placed directly over a small Fletcher burner and charged with 200 grams of solid, chlorate-free sodium hydroxide in large sticks, and 60 cc. water. (Fusions using chlorate-containing alkali give lower yields and are,

moreover, very dangerous. *Explosive!*) The alkali is melted with a large flame. The melt is water clear, and foams as the temperature is raised gradually to 270°C., at which point the foaming ceases. The powdered sodium sulfonate is now added, with continued stirring, in teaspoon portions, and the temperature is raised slowly to 290°. The dry sodium salt is seen to disappear gradually as the dark colored, lustrous

Influence of NaCl and Na₂SO₄ on the Solubility of Sodium Naphthalene-β-Sulfonate (American Data)

β Salt and NaCl (grams in 100 grams of solution)									
25°C.		30°C.		40°C.		50°C.		65°C.	
β Salt	NaCl	β Salt	NaCl	β Salt	NaCl	β Salt	NaCl	β Salt	NaCl
5.58	0	6.24	0	7.98	0	9.75	0	14.6	0
3.46	2.38	1.21	4.84	1.46	5.62	4.15	2.9	8.47	2.93
0.31	9.19	0.16	13.08	0.65	8.47	2.17	5.42	6.12	3.81
0.15	13.16	0	26.5	0	26.70	1.05	8.39	1.96	7.19
0	16.81					0	26.8	1.26	10.83
0	26.43							0	27.2

β Salt and Na ₂ SO ₄ (grams in 100 grams of solution)									
25°C.		30°C.		40°C.		50°C.		65°C.	
β Salt	Na ₂ SO ₄	β Salt	Na ₂ SO ₄	β Salt	Na ₂ SO ₄	β Salt	Na ₂ SO ₄	β Salt	Na ₂ SO ₄
3.42	1.97	1.97	4.81	4.3	2.85	5.72	2.87	11.75	1.68
2.41	3.06	0.26	13.23	2.18	5.83	3.49	5.35	7.37	5.28
1.78	4.34	0	29.1	1.2	8.48	1.93	8.24	6.7	5.45
0.93	7.4			0.77	10.92	1.42	10.01	1.90	12.0
0.62	9.25			0	32.5	0	31.9	3.14	10.86
0.52	10.52							0.25	26.96
0.10	13.15							0	31.0
0	21.9								

sodium naphtholate is formed. The watery consistency of the mixture permits the addition of much more sodium sulfonate than most procedures specify. In laboratory preparations, 1.5 parts of the sulfonate (300 grams in this case) to 1 part of alkali can easily be added. (In plant processes using correctly designed equipment and proper firing, 2.8 parts of the salt can be used for each part of alkali, and charring or excessive thickening of the mixture is not encountered.) When a temperature of 290° has been reached, about one-half of the sulfonate should have been added. The temperature is then raised carefully to 300° and, when three-fourths of the salt (225 grams) has been added,

to 305°. Finally, the temperature is raised to 318° when all of the salt has been added. Higher temperatures should not be used. The melt becomes gritty due to the sodium sulfite which has separated, and the naphtholate gradually replaces the sulfonate, which disappears slowly. The melt is held at 318° for 15 minutes, carefully avoiding overheating. The whole operation requires about 1 hour. Too rapid addition of the sulfonate results in charring and lowering of the yield.

The reaction mixture is poured out into a low dish, and after cooling, it is broken up and returned to the fusion kettle with 500 cc. water. Most of the mixture dissolves easily on careful warming, leaving a crust of undissolved sodium sulfite. The solution is poured off and more water is added until all the material is dissolved. More than 2 liters water should not be required. The combined solutions are placed in a porcelain dish and heated to boiling over a Fletcher burner. Sulfuric acid (50 per cent) is added until the reaction to thiazole paper almost disappears. The solution is then cooled slightly and filtered through a large suction funnel into a warm flask. The volume of neutralized solution ready for filtration is about 3 liters. It is colorless or light yellow.

The clarified solution is heated to boiling and enough 50 per cent sulfuric acid is added to make the solution strongly acid to litmus. (If there is not time to filter off the β -naphthol within an hour's time, hydrochloric acid should be used. Otherwise, sodium sulfate is also precipitated.) There is no odor of sulfurous acid. The β -naphthol is insoluble in neutral sulfite solution in the presence of some bisulfite. It separates as an oil at first, but solidifies immediately. After an hour, the precipitate can be filtered off without losing more than traces. The product is collected on a suction funnel with a cotton filter, washed thoroughly with cold water, and dried at low temperature, either in a vacuum drying oven or in an ordinary drying oven. If the drying temperature is too high, the product melts and sublimes.

The yield of dry, crude naphthol from 300 grams of β salt is about 150 grams (93 per cent pure), of distilled product about 135 grams, m.p. 122°.

The crude product suffices for some uses, but it must be thoroughly purified to meet the specifications for the commercial product. For this purification, only vacuum distillation is used today.

Technical Observations. The sulfonation of naphthalene is carried out in huge cast iron kettles holding 1000 to 3000 liters. Heating is done either directly with generator gas or by means of a steam jacket (double wall) (Figure 31) which must withstand at least 6 atmospheres in order that the required temperature of 174° can be attained.

Instead of converting the α -sulfonic acid into the β isomer by long heating,

another scheme is used in the industry. After several hours of heating, steam is blown into the sulfonation mixture, whereby the α acid is split into naphthalene and sulfuric acid, leaving the β acid unchanged. In this way, a mixture of the β acid and sulfuric acid is obtained, substantially free from the isomeric sulfonic acid. The technical process is different from the laboratory procedure in other respects also. Instead of using salt, which is much too costly, to precipitate the

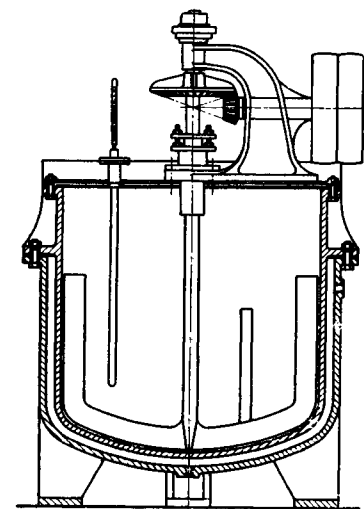

Fig. 31. Sulfonation and nitration kettle with steam jacket (double wall).

naphthalene- β -sulfonic acid, the sulfonation mixture is treated with the waste liquor from the naphthol, which contains sulfite. Sulfur dioxide is given off and is passed into the diluted β -naphthol melt. The β -naphthol is thereby precipitated, and, as pointed out, the resulting mother liquor serves in precipitating the β -naphthalenesulfonate. Only in this way can the β -naphthol be manufactured cheaply. Also, careful extraction of the crude β -naphthol with dilute sodium hydroxide recovers the α -naphthol present, since the latter is more easily soluble in alkali. The determination of mixtures of α - and β -naphthol is described in the Analytical Section. In some β -naphthol plants, the washed crude naphthol is fused in closed iron kettles (the aqueous mother liquor is drained off) and dried in vacuum. It is then filtered hot through a small filter press. In this way, most of the salts present in the crude naphthol are retained in the filter press, and the subsequent vacuum distillation goes very smoothly with little pitch formation. Technical β -naphthol is up to 99.9 per cent pure. It has been marketed in recent years in the flake form which is much easier to work with and is free from dust.

Sulfonation of β -Naphthol

Sulfonation of β -naphthol under various conditions of temperature and sulfuric acid concentration gives rise to a whole series of mono- and

polysulfonic acids. Only a few of the typical reactions will be described in detail here in order to give the beginner a picture of this field of intermediates.

The first product formed by the action of concentrated sulfuric acid on β -naphthol is 2-naphthol-1-sulfonic acid (page 199). This compound, however, is very unstable and rearranges, even in the cold, in the presence of excess sulfuric acid, to form 2-naphthol-8-sulfonic acid (Bayer acid, croceine acid), and this in turn rearranges, only partially in the cold but completely at higher temperatures, into 2-naphthol-6-sulfonic acid (Schaeffer acid).

When an excess of acid is used, there are always formed also some 2-naphthol-3,6-disulfonic acid and 2-naphthol-6,8-disulfonic acid. These disulfonic acids usually react with diazonium salts to yield, respectively, red and yellow dyes, and are therefore known commonly as R acid (R=*rot*) and G acid (G=*gelb*). R and G acids are the main sulfonation products if a large enough excess of sulfuric acid is used, relatively more of the R acid being formed at low temperatures and more G acid at higher temperatures. Under very vigorous conditions (oleum at elevated temperatures), both disulfonic acids are converted to 2-naphthol-3,6,8-trisulfonic acid. All of these acids are important starting materials in the azo dye industry. In most cases, it is practically impossible to prepare any one of them separately; it is necessary, as a rule, to separate them from mixtures.

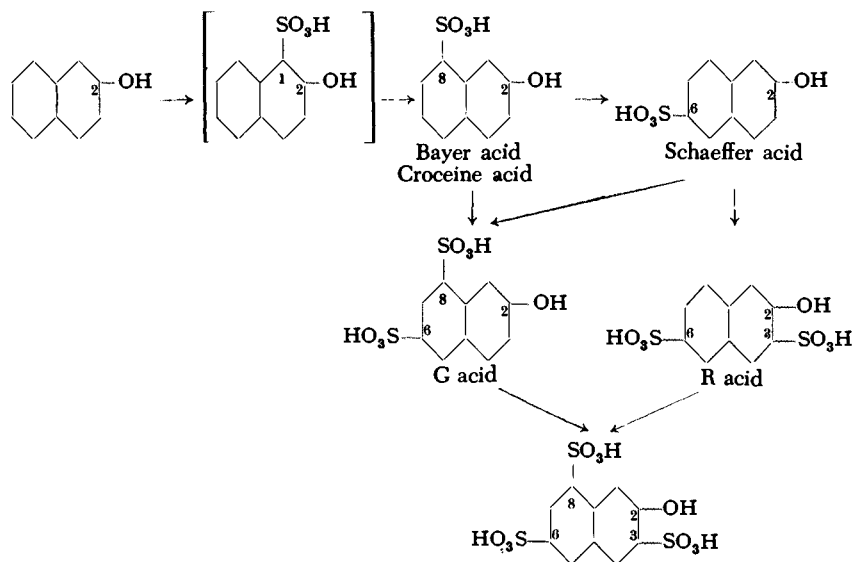

Sulfonation reactions, especially those carried out at low temperatures, often form, in addition to the above acids, appreciable quantities of 2-naphthol-1,6-disulfonic acid and 2-naphthol-1,3,6-trisulfonic acid. Since these products have no technical value, the sulfo group in the 1 position is split off by diluting the sulfonation mixtures with water and heating for 0.5 to 1 hour at 90–100°.

Separation of the individual sulfonic acids from a reaction mixture is based on the different solubilities of their alkali salts. The three acids which are technically the most important and also which are most frequently formed simultaneously are the 2,6-monosulfonic acid (Schaeffer acid), and the 2,3,6-, and 2,6,8-disulfonic acids (R and G acids). Of these, the first gives a sodium salt having the lowest solubility in cold water, and the presence of salt has little effect on its relatively low solubility. To the contrary, the sodium salt of R acid is much more soluble in pure water, but is largely precipitated by a relatively small amount of salt. The sodium salt of G acid is easily soluble in highly concentrated salt solutions; on the other hand, its potassium salt is only moderately soluble in cold water and still less soluble in potassium chloride solutions. The foregoing statements apply to the neutral salts in which all of the sulfo groups are neutralized but the hydroxyl group is free. Notwithstanding statements in the literature to the contrary, the salts which separate from neutral or acid solution are always these neutral salts and never the acid salts in which free sulfo groups are still present. In alkaline solution, however, basic salts are formed, in which the hydroxyl group is also neutralized. These basic salts are more easily soluble than the neutral salts and are not suitable for isolation. Separation of mixtures, therefore, is always carried out in neutral or acidic solution.

In practice, the neutral or slightly acid solution of the sodium salts, containing little or no sodium chloride, is evaporated to a definite volume which depends on the composition of the reaction mixture and which is selected so that on cooling only the sodium 2-naphthol-6-sulfonate crystallizes out, but this as completely as possible. The precipitate is removed, and, to the filtrate, usually after further evaporation, is added enough salt to make it an 18 to 20 per cent salt solution. R salt then precipitates when the solution is cooled. Potassium chloride is then added to the mother liquor to precipitate the potassium salt of G acid.

In order to obtain really pure products from a given reaction mixture, not only is it necessary to have exactly the correct concentration and quantity of salt, but the filtration and washing of the separate precipitates must be done with exacting care in order to remove the

mother liquor as completely as possible with a minimum of wash liquid.

It should be emphasized that β -naphthol should always be finely pulverized before use. If this precaution is not taken, part of the naphthol is sulfonated but the large lumps floating around in the mixture are not attacked and the results are completely unsatisfactory. This is also the case if the reaction mixture is merely allowed to stand and is not stirred continuously. The apparatus used is the same as that used for the preparation of naphthalene- β -sulfonic acid (Fig. 19).

2-Naphthol-6-sulfonic Acid (Schaeffer Acid) (R Acid and G Acid)

To 250 grams of concentrated sulfuric acid (66° Bé) is added, with stirring, 144 grams (1.0 mole) of finely powdered, pure β -naphthol. The temperature rises to about 30°C. The mixture is heated for 8 hours in a boiling water bath, and then poured while still warm into 1 liter water. The diluted solution is held at 95–100° with stirring for about 1 hour. If necessary, water is added so that the total volume does not become less than 1 liter. An additional 500 cc. water and 100 grams of anhydrous sodium sulfate (or the corresponding amount of the hydrated salt) are then added, and the solution is neutralized at about 90° by the addition of chalk (about 190 grams is required). The chalk must be added very carefully in small portions, particularly toward the end of the neutralization, in order to prevent foaming over. The mixture is finally boiled and filtered hot to remove the calcium sulfate which is washed carefully with hot water until a portion of the washings, treated with soda, gives only a weak coloration with diazotized aniline. The combined filtrate and washings are heated to boiling and freed from residual calcium compounds by the addition of enough anhydrous soda (about 30 grams) to make the solution barely alkaline to phenolphthalein. (Complete removal of the calcium is necessary only if it is important that the product dissolve to form a clear solution even in the presence of soda.) At this point, a filtered test portion of the filtrate should give no further precipitation when more soda is added. The precipitated calcium carbonate is filtered off and washed with hot water, and the filtrate is made just acid with concentrated hydrochloric acid (about 40 cc.) and evaporated to 1 liter. The concentrated filtrate is cooled with stirring, during which the volume decreases still more by evaporation; after cooling, the volume should be 800 cc.

The mixture is allowed to stand overnight, and the resulting thick

paste is filtered by suction. In this filtration, the solid must be pressed out thoroughly, using a pestle or the flat surface of a glass stopper, to prevent the formation of cracks or perforations in the filter cake and to ensure as complete removal of the mother liquor as possible. When no more drops of filtrate are formed, the vacuum is broken and 50 cc. cold water is poured into the funnel. Again, care is taken that no canals are formed through which water can pass without effective washing, and that the wash water works its way uniformly through the precipitate. Vacuum is reapplied, slowly at first and then as fully as possible, and the solid is pressed out thoroughly again. Washing with 50-cc. portions of cold water is repeated twice more. If the operations are carried out properly, the final precipitate contains such a small quantity of liquid that pressing in a screw press can be omitted unless large quantities are being worked with. The product, after drying in a steam heated oven, consists of 150–155 grams of technically pure sodium 2-naphthol-6-sulfonate, 1 gram of which uses 36.5 to 37 cc. 0.1 *N* diazo solution.

The yield is about 56 per cent of the theoretical amount, and the product is usable for most purposes without further treatment. The last traces of disulfonic acids can be removed, if desired, by recrystallization from 3 to 4 parts of hot water.

The combined filtrate and wash water from the monosulfonate are evaporated to a volume of 300 cc., and 40 grams of salt is added to the hot concentrated solution. The mixture is allowed to stand overnight, and the resulting precipitate is filtered off and washed three times with 20-cc. portions of a half-saturated salt solution (mixture of equal parts of saturated salt solution and water), following the same filtering procedure used with the first precipitate. The product, after being dried in a steam heated oven, consists of 50 to 55 grams of crude R salt, of which 1 gram corresponds to 23 to 26 cc. 0.1 *N* diazonium solution. Thus, the yield is 12.5 to 13 per cent of the theoretical amount. The purification of this product is discussed later.

The filtrate from the R salt is heated to boiling and 60 grams of potassium chloride is added. The solution is cooled and allowed to stand overnight. The copious precipitate is filtered off and washed, as described above, with 10 per cent potassium chloride solution. The product, dried in a steam heated oven, weighs 40 to 45 grams, and consists chiefly of G salt. One gram uses 23 to 25 cc. 0.1 *N* *p*-nitrodiazobenzene solution. The yield is about 10 per cent of the theoretical amount.

The last mother liquor still contains about 12 per cent of the starting material in the form of sulfonic acids which can be titrated with *p*-nitrodiazobenzene solution. Besides residual Schaeffer salt, R salt, and G salt, other isomers are present which have not been investigated.

The crude R salt obtained in the above procedure always contains some Schaeffer salt. The amount of the impurity should not be more than 5 per cent if the work has been done carefully. The crude R salt is usable as such for many purposes, but, if desired, a purified material can be obtained in the following way.

50 grams of the crude product is dissolved in 250 cc. boiling water and 25 grams of salt is added. The solution is then filtered to remove a slight turbidity and placed in the ice chest overnight. The resulting precipitate is filtered off with suction and washed with three portions, totaling 50 cc., of a mixture of 1 part of saturated salt solution and 3 parts of water. In this way, 65 to 70 per cent of the crude product is obtained as pure R salt if the crude product did not contain more than 5 per cent of the other sulfonic acids. In other cases, the purification must be repeated.

The filtrate is evaporated to half its original volume (i.e., to 125 cc.). On cooling, about 25 per cent of the original crude material crystallizes out. This second fraction is mainly Schaeffer salt which can be obtained in a pure state by recrystallizing from 4 parts of water. The mother liquor from the second fraction gives a precipitated mixture of Schaeffer and R salts on addition of salt. This material can be separated into its constituents by repeating the operations described.

The fraction obtained by precipitation with potassium chloride is G salt which contains 5 per cent, at the most, of R salt as an impurity. In the laboratory, this crude G salt can be purified by recrystallization from water. The method used in the plant is based on the fact that G salt couples with diazonium compounds much less readily than either R salt or Schaeffer salt. A test is made to determine the content of easily coupling sulfonic acids by titrating a sample with diazobenzene or diazoxylene in dilute solution. The crude G salt is then treated with the correct amount, as indicated by the titration, of a slowly reacting diazo compound, usually diazoxylene. Under these conditions, only the impurities couple, leaving a solution of pure R salt after the dye which is formed is removed. The G salt solution can be used directly in the preparation of azo dyes. The dye from the impurities is sold under the name Ponceau.

The products can be tested for purity by determining their fluorescence and their behavior with diazotized *p*-aminoacetanilide (acet-*p*-phenylenediamine). Pure Schaeffer salt in a neutral solution exhibits no perceptible fluorescence; its alkaline solutions have a *violet-blue* fluorescence of low intensity. R salt and G salt both show *greenish blue* fluorescence, weak in neutral solution, but very intense in alkaline solution. A slight contamination of Schaeffer salt by either R or G salt is sufficient to mask the fluorescence of the Schaeffer salt. When the products are colorless, the presence of small amounts of impurities in Schaeffer salt can be detected in this way, and by comparison with known mixtures the amount of contamination can be estimated. When the crude products are strongly colored, however, the sensitivity and accuracy of this test are greatly reduced.

Schaeffer salt reacts with diazotized *p*-aminoacetanilide to give an easily soluble orange red dye which is precipitated only by the addition of a large amount of salt. The dye from the same diazo compound and R salt, on the other hand, is almost completely precipitated, by very small amounts of salt, in the form of lustrous bronzy crystals which appear bluish red by transmitted light; the filtrate has only a light bluish red color. The presence of Schaeffer salt is shown by a

stronger, more yellowish color in the filtrate. In dilute solution, slightly alkaline with carbonate, G salt does not couple, or couples very slowly, with diazotized *p*-aminoacetanilide. Hence, in testing a sample of G salt, an immediate formation of a deep red coloration shows the presence of an impurity, usually Schaeffer or R salt. The presence of G salt in products consisting mainly of the other sulfonic acids is shown by the intense G salt fluorescence in the filtrate after the dye, formed from the product and diazotized *p*-aminoacetanilide, has been salted out and filtered off. This filtrate shows no further coupling reaction with diazotized *p*-aminoacetanilide, but does react to form dye with more energetic diazo compounds, e.g., that from *p*-nitroaniline.

The titration of Schaeffer salt and R salt is done most satisfactorily with diazotized *p*-aminoacetanilide in slightly alkaline solution (carbonate), that of G salt with diazotized *p*-nitroaniline in the presence of bicarbonate. In the case of mixtures, the difference between the two titrations gives a measure of the amount of G salt present.

The analysis of mixtures of Schaeffer salt and R salt is described in the Analytical Section.

2-Naphthol-6,8-disulfonic Acid (G Acid) and 2-Naphthol-3,6-disulfonic Acid (R Acid)

If G acid is desired as the chief product, the reaction is effected with a larger quantity of sulfuric acid and higher acid strength, at a moderate temperature, in no case over 60°C.

To 200 grams of 100 per cent sulfuric acid, well stirred and cooled in running water, is added 72 grams (0.5 mole) of pure, finely powdered β -naphthol at such a rate that the temperature does not rise above 20°. The mixture is stirred at room temperature for 1 hour, after which a test sample should form a clear solution with water and the diluted solution should show no turbidity on heating. Again with cooling, 100 grams of 20 per cent oleum is added slowly, while the temperature is not allowed to rise appreciably above 20°. The reaction mixture is now heated in a water bath to 55–60° and stirred at this temperature for about 40 hours. At this point a test sample, diluted with water and made slightly alkaline with soda, is treated with diazotized *p*-aminoacetanilide. Only the easily salted out, blue red, R salt dye should be formed, and none of the more soluble orange red dye from Schaeffer salt (see preceding section). Toward the end of the sulfonation, a crystalline precipitate usually separates, and the reaction mixture becomes a thick paste which is, however, easily stirred. The mixture is poured into 1 liter water, 75 grams of anhydrous sodium sulfate is added, and the solution is stirred for 1 hour at 95°, replacing the water lost by evaporation. By this treatment, any 2-naphthol-1,6-disulfonic acid and 2-naphthol-1,3,6-trisulfonic acid are converted to Schaeffer

acid and R acid, respectively. The hot solution is then neutralized by adding about 300 grams of chalk with stirring. This addition can be made rather rapidly without danger of foaming over. Filtering and washing of the calcium sulfate precipitate, removing the remaining calcium compounds by precipitation with soda ash (about 25 grams), and re-acidifying the filtrate with concentrated hydrochloric acid (about 30 cc.) are carried out exactly as in the preparation of Schaeffer acid. Finally, the solution is evaporated to 400 cc., treated hot with 60 grams of salt, and allowed to cool with stirring. Most of the R salt, and some Schaeffer salt which is present, crystallize out on standing overnight. The precipitate is filtered off and washed with half-saturated salt solution, proceeding exactly as described in detail for the isolation of Schaeffer salt (page 194). The dried product weighs about 65 to 70 grams. Titration with diazotized *p*-aminoacetanilide (120 cc. 1 *N* solution) and with diazotized *p*-nitroaniline (150 cc. 1 *N* solution) shows that the product corresponds to about 30 per cent of the β -naphthol used and contains about 80 per cent R salt with a very small amount of Schaeffer salt, and 20 per cent G salt. Pure R salt can be obtained by the method described on page 196.

The filtrate is reheated to boiling, treated with 100 grams of potassium chloride, allowed to cool with stirring, and then left overnight. The precipitate is filtered off, washed thoroughly with three 50-cc. portions of 10 per cent potassium chloride solution, and dried in a steam heated oven. The product weighs 140 to 150 grams and corresponds to about 300 cc. 1 *N* solution of diazotized *p*-nitroaniline. Thus, the yield is about 60 per cent of the theoretical amount. In carefully conducted preparations, the colorless product is pure G salt which gives no immediate dye formation with diazobenzene in weakly alkaline, dilute solution.

The mother liquor still contains about 10 per cent of the β -naphthol in a complex mixture with various sulfonic acids which cannot be separated in any way which is feasible technically.

2-Naphthylamine-1-sulfonic Acid (Tobias Acid)
from β -Naphthol

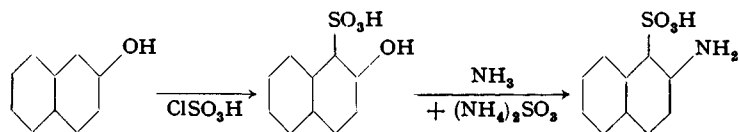

(a) 2-Naphthol-1-sulfonic Acid from β -Naphthol

In a 1-liter, five-necked flask, fitted with a stirrer, preferably of the paddle type, operating through a mercury seal in the center neck, a dropping funnel, a thermometer, a gas inlet tube, and a gas outlet tube, 72 grams (0.5 mole) of dry β -naphthol is treated with 280 grams of hot (100°C.) completely dry nitrobenzene. (The simplest method for drying nitrobenzene is to distill and discard the first fraction which contains all of the water.) The resulting completely clear solution is allowed to cool with stirring, part of the naphthol crystallizing out. The mixture is cooled in ice, and 35 cc. (62 grams) sulfuric acid-free chlorosulfonic acid is dropped in slowly, while the temperature is kept below 5°. The hydrogen chloride which is formed is passed through a calcium chloride tube into a suitable absorption apparatus. The β -naphthol goes into solution rapidly, and toward the end of the reaction part of the naphtholsulfonic acid precipitates. When all of the chlorosulfonic acid has been added, the remaining dissolved HCl is swept out by means of a stream of *dry* air.

Chlorosulfonic acid takes up water readily, decomposing into sulfuric and hydrochloric acids. Therefore, it must be kept in containers having absolutely tight ground glass stoppers. Ordinary glass stoppers are not usually sufficiently tight for this purpose. If the chlorosulfonic acid is not known to be of the highest quality, it should be distilled before use, carrying out the distillation in the complete absence of moisture.

The nitrobenzene solution, together with the suspended solid material, is shaken with a mixture of 300 cc. water and 100 grams of ice, then twice with 100-cc. portions of cold water. The combined aqueous extracts are filtered through a moistened paper and then saturated with 200 grams of salt, whereupon sodium 2-naphthol-1-sulfonate is precipitated in colorless plates. Stirring is continued until all of the salt is dissolved, and the mixture is allowed to stand overnight, then filtered. The product is pressed out and washed twice with saturated salt solution. The filter cake is used directly for the preparation of 2-naphthylamine-1-sulfonic acid after tests have shown that it does not fluoresce in soda solution and does not yield a water soluble, orange red dye with diazotized aniline and thus does not contain isomeric naphtholsulfonic acids.

If it is desired to isolate the sodium sulfonate in a pure state, the filter cake is dissolved in a small amount of cold water, the solution is extracted with several portions of benzene to remove nitrobenzene, then filtered and the product again

precipitated with salt, filtered off, washed with saturated salt solution, pressed out, and dried. This yields a material which is pure except for the presence of salt, which can be removed if desired by crystallization from alcohol.

The product is analyzed by boiling a weighed sample under reflux for 2 hours with 10 parts of 20 per cent sulfuric acid. The sulfo group is split off by this treatment. The resulting β -naphthol is dissolved by adding dilute sodium hydroxide and titrated with 0.1 *N* diazobenzene solution.

(b) 2-Naphthylamine-1-sulfonic Acid from 2-Naphthol-1-sulfonic Acid

The filter cake of sodium 2-naphthol-1-sulfonate, obtained under (a), is placed in an enameled autoclave of about 1-liter capacity with 250 cc. 20 per cent ammonia and an ammonium bisulfite solution prepared by saturating 60 cc. 20 per cent ammonia with SO_2 with cooling. The mixture is heated in the autoclave for 8 hours at 145–150°C. (internal temperature). In large scale preparations, the ammonia is then distilled off and reused in the next run. It is more convenient in laboratory preparations to saturate the solution with salt, whereupon the sodium salt of 2-naphthylamine-1-sulfonic acid is precipitated almost completely. The mixture is allowed to stand overnight, and then the sulfonate is filtered off and washed well with saturated salt solution to remove ammonia and ammonium salts. The resulting filter cake is dissolved in hot water and the solution is filtered and treated with sufficient concentrated hydrochloric acid to make it distinctly acid to Congo red. After cooling the solution thoroughly, the precipitate, consisting of the free 2-naphthylamine-1-sulfonic acid in the form of needles, is filtered off, washed with cold water, and dried. The yield is 98 grams, or 83 per cent of the theoretical amount based on β -naphthol.

As mentioned earlier (page 192), 2-naphthol-1-sulfonic is the first product formed by the reaction of concentrated sulfuric acid on β -naphthol. It is rearranged so rapidly by the unavoidable excess of sulfuric acid, however, that it cannot be prepared by direct sulfonation with sulfuric acid.

The procedure described above involves sulfonation in the absence of free sulfuric acid at low temperatures, and avoids the use of an appreciable excess of the sulfonating agent. Similar procedures are generally applicable to the preparation of sulfonic acids which cannot be prepared satisfactorily by the ordinary sulfonation methods, because they are easily isomerized or sulfonated further by concentrated sulfuric acid. Even compounds which are ordinarily converted directly into disulfonic acids, such as carbazole, 4,4'-dihydroxydiphenylmethane, etc., can be monosulfonated in this way.

2-Naphthol-1-sulfonic acid does not couple with diazo compounds under ordinary conditions, because the single reactive position in the β -naphthol nucleus is occupied. However, at higher temperatures and in acid media, the sulfo group is replaced by the azo radical and the dye that is formed is the same as that from

β -naphthol. This property is made use of in developing paranitraniline red on the fiber.⁶¹

The chief use of 2-naphthol-1-sulfonic acid is as an intermediate in the preparation of 2-naphthylamine-1-sulfonic acid. The latter, when diazotized and coupled with β -naphthol, yields the valuable lake dye, lithol red R, which is used in large quantities.

The conversion of 2-naphthol-1-sulfonic acid into the corresponding naphthylaminesulfonic acid is another example of the Bucherer reaction which was discussed in connection with the preparation of 1-naphthol-4-sulfonic acid (page 182).

1-Amino-2-naphthol-4-sulfonic Acid from β -Naphthol

Preparation of an Aminonaphtholsulfonic Acid from the Hydroxynitroso Compound (Quinonemonoxime)

(a) *Nitroso- β -naphthol*. In a 3-liter beaker, 72 grams (0.5 mole) (the preparation starting with 1 mole would require too large a volume) of β -naphthol is dissolved at 50°C. in a mixture of 65 grams of 35 per cent sodium hydroxide solution and 750 cc. water. To this solution, which should have a distinct, but weak, reaction to thiazole paper, are added 36 grams of 100 per cent sodium nitrite and enough water and ice to bring the volume to 1.5 liters and to lower the temperature to 0°. About 160 grams of 40 per cent sulfuric acid is then added over a period of three hours with good stirring. The solution should become distinctly acid to Congo red and show a positive reaction with starch-iodide paper. After at least 1 hour, the nitrosonaphthol is filtered off on a large suction funnel and washed thoroughly. It is chemically pure provided that pure β -naphthol was used.

(b) *Reduction and rearrangement to aminonaphtholsulfonic acid*. The moist nitrosonaphthol is stirred with a small amount of water to form a uniform paste which is cooled in ice to 5°C., and 320 grams of sodium bisulfite solution (about 25 per cent SO_2) is added in one portion. (It is essential that the bisulfite solution be titrated to determine the SO_2 content. For each mole of β -naphthol, 2.5 moles SO_2 are used.) The nitrosonaphthol goes into solution in a short time, but if necessary, a small amount of dilute sodium hydroxide is added carefully.

The solution is filtered to remove any tarry material which it contains. (The hydroxylaminesulfonic acid may be salted out to yield the Alsace green J or Dioxine N of the trade, a dye which is used to a certain extent in calico printing. Its iron lake is very fast to light.)

⁶¹ The Calico Printers Assoc. and E. Fourneaux, Ger. Pat. 204,762 (1909) [*Frdl.*, 9, 408 (1908–1910); C.A., 3, 958 (1909)].

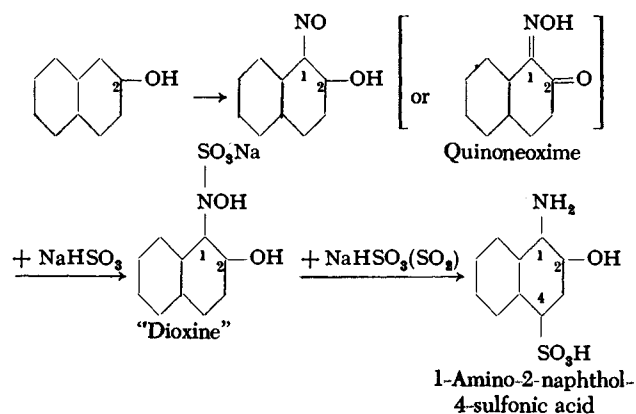

The filtered solution, about 1 liter in volume, is transferred to a beaker, and a mixture of 100 grams of 66° Bé sulfuric acid and 200 grams of water is added at 25°C. The solution should now have a strong mineral acid reaction. After 1 hour, the solution is heated to 50°, then allowed to stand overnight. The reaction mixture solidifies to a cake of the free aminonaphtholsulfonic acid, which is filtered off and washed thoroughly with water. The yield is about 90 per cent based on the β -naphthol used.

The diazotization of 1-amino-2-naphthol-4-sulfonic acid is described on pages 242 and 248; an alternate method for preparing the same diazo compound is given on page 178. Coupling with β -naphthol yields palatine chrome black 6B⁶² (eriochrome blue-black R, salicine black U), first discovered by Badische A.S.F., and independently and almost simultaneously by Geigy (Sandmeyer) and by Kalle (Elbel). Coupling with α -naphthol gives eriochrome blue-black B⁶³, discovered by Geigy. Both of these dyes are very fast blue-black chrome dyes. It is interesting that the coupling reaction with α -naphthol in strongly alkaline solution involves only the position ortho to the hydroxyl group.

The diazo compound of 1-amino-2-naphthol-4-sulfonic acid is so stable that it can be dried without danger, and can be nitrated in concentrated sulfuric acid solution with mixed acid.⁶⁴ The nitrated diazo compound reacts with the two naphthols to give the commercial chrome black wool dyes, eriochrome black T and A,⁶⁵ which are cheap and almost unsurpassed for fastness.

The above method of sulfonation with sulfurous acid finds further application in the preparation of *p*-aminophenoldisulfonic acid from nitrosodimethylaniline and sodium bisulfite. In the rearrangement to the disulfonic acid, the dimethylamino group is split off with the formation of the *p*-aminophenol derivative. Pure dimethylamine is formed in the reaction.

⁶² Badische A. und S. F., Ger. Pat. 156,440 (1904) [*Frdl.*, 8, 656 (1905-1907)].

⁶³ Geigy, Ger. Pat. 181,326 (1904) [*Frdl.*, 8, 668 (1905-1907); *C.A.*, 1, 2329 (1907)].

⁶⁴ Sandmeyer and Hagenbach (Geigy), Ger. Pat. 164,655 (1905) [*Frdl.*, 8, 647 (1905-1907)].

⁶⁵ Geigy, Ger. Pat. 169,683 (1906) [*Frdl.*, 8, 673 (1905-1907)].

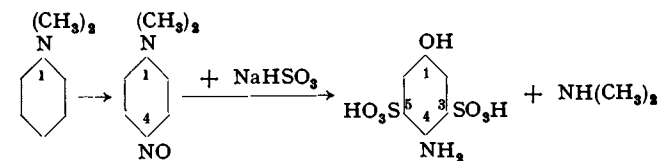

β -Naphthylamine from β -Naphthol

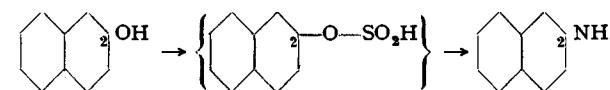

A mixture of 144 grams (1.0 mole) of pure β -naphthol and 600 grams of ammonium sulfite solution is heated in an autoclave equipped with a stirrer and heated in an oil bath. (The ammonium sulfite solution can be prepared by saturating 250 grams of 20 per cent ammonia with SO_2 , then mixing the resulting solution with an additional 250 grams of ammonia.) To this mixture is added 125 grams of 20 per cent ammonia, and the charge is heated 8 hours at a temperature (internal) of 150°C. and a pressure of about 6 atmospheres (steel tube manometer!). The autoclave is allowed to cool and the resulting cake of β -naphthylamine is ground up in a mortar and washed thoroughly with water in a suction funnel. The ammonium sulfite solution can be used over again. The washed base is dissolved in a warm solution of 110 grams of hydrochloric acid (containing no sulfuric acid) and 1.5 liters water, and the solution is filtered to remove some unreacted β -naphthol. The filtrate is mixed with a solution of 100 grams of anhydrous sodium sulfate in 250 cc. water to precipitate the β -naphthylamine as the sulfate. The mixture is allowed to stand overnight, then the precipitate is filtered off and washed well with cold water. This product, after being dried, can be used directly for many purposes (see page 205).

To prepare the free base, the sulfate is mixed with 1 liter water and treated with 60 grams of soda ash dissolved in a small amount of water. The reaction requires several hours because of the low solubility of the sulfate, but it can be accelerated by continuous stirring and heating to 80°. The base is filtered off, washed, and dried at 80°. The yield is about 130 grams, or 85 to 95 per cent of the theoretical amount.

Technical Observations. It is absolutely necessary to use an autoclave heated by an oil bath or steam jacket for such reactions. The naphthylamine separates out at the bottom of the container as an oily layer, and unless an oil bath is used, overheating occurs to such an extent that, in spite of the stirring, a large part of the product is converted to dinaphthylamine and decomposition products. The same conditions prevail in the preparation of α -naphthol (page 180).

β -Naphthylamine is usually vacuum distilled in the plant. The distillation must be done very carefully, since the compound decomposes easily. For sulfonation reactions, if the free base is not isolated, the thoroughly dried sulfate, mixed with 1 per cent soda (see also primuline), is added to sulfuric acid or oleum.

The Bucherer method has completely replaced the older procedure of heating the naphthol with ammonia. This process gave only about a 70 per cent yield at pressures of 50 to 60 atmospheres. The Bucherer reaction was discussed in more detail on page 182.

2,8,6- and 2,5,7-Aminonaphtholsulfonic Acids (Gamma and J Acids) from β -Naphthylamine

These two important sulfonic acids can be prepared in various ways. Three methods are used for preparing γ acid, while J acid, so far as is known, is prepared only from naphthylamine, although by varying procedures. The starting material in all cases is β -naphthol; the reactions involved are shown in the following scheme. We shall describe here only the preparations starting from β -naphthylamine. The processes starting from β -naphthol and its sulfonic acid derivatives are described briefly in the technical observations following the preparation of J acid.

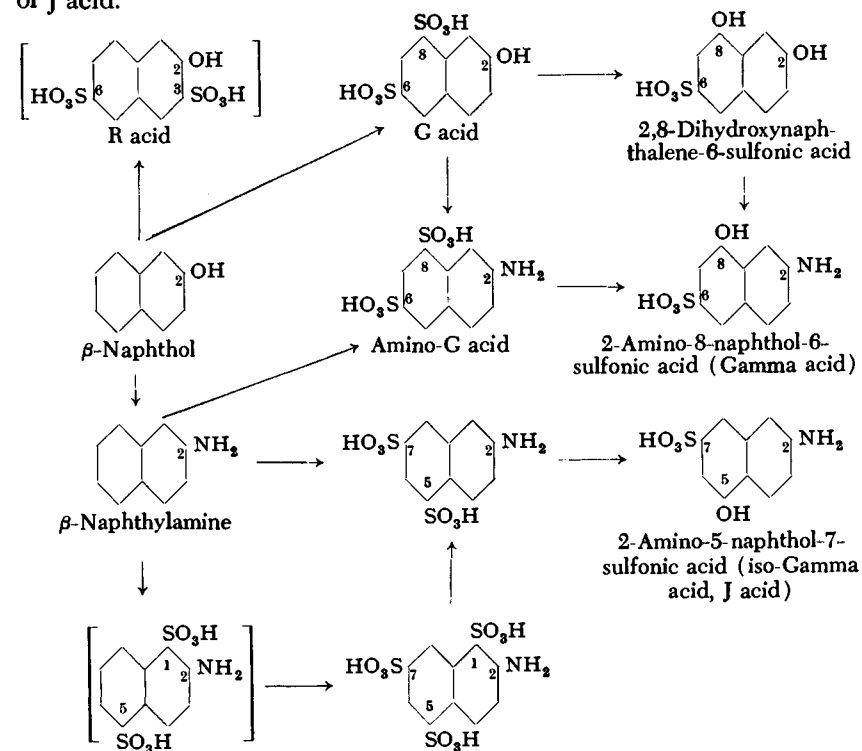

(a) 2,6,8- and 2,5,7-Naphthylaminedisulfonic Acids from β -Naphthylamine

To 800 grams of 15 per cent oleum is added, over a period of 10 minutes, 192 grams (1.0 mole) of finely powdered β -naphthylamine sulfate which has been intimately mixed with 1 gram of anhydrous carbonate. The temperature should not be allowed to rise above 50°C. The reaction mixture is now tested for complete solubility in water and soda; monosulfonation is usually complete in 15 minutes. The mixture is cooled to 40°, and 350 grams of 66 per cent oleum is added over a period of 15 minutes with continuous stirring. The sulfonation is continued for 1 day at 55°, then for an additional day at 85°. Under these conditions, the 2,5,7- and 2,1,5-naphthylaminedisulfonic acids, which are formed first, are converted to 2-naphthylamine-1,5,7-trisulfonic acid:

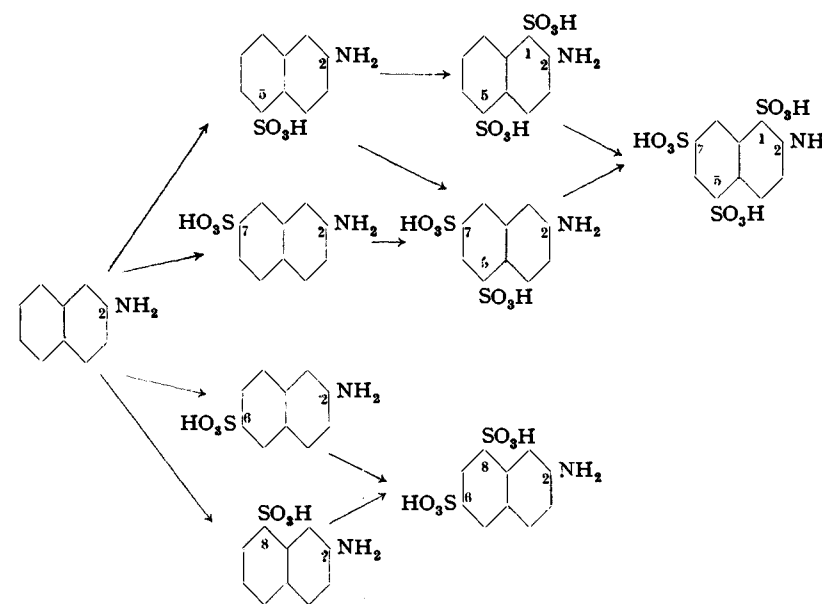

On completion of the sulfonation (which can be carried out more or less rapidly according to various procedures), the reaction mixture is cooled to 50°C. and poured into a stirred mixture of 800 grams of water and 1100 grams of ice. The final temperature should be about 60°. Pure 2-naphthylamine-6,8-disulfonic acid precipitates and is filtered off after the mixture has been held for 6 hours at 20°. The filter cake weighs about 210 grams (corresponding to 30 grams of NaNO_2).

In the dye industry, it is customary to express quantities in terms of nitrite equivalents. Since one gram molecule of any given amine requires 69 grams of NaNO_2 (equivalent to 1 mole of nitrous acid) in diazotization, yields of amines are commonly stated as corresponding to x per cent or x grams of nitrite. Thus, if a given quantity of naphthylaminesulfonic acid reacts with 17 grams of nitrite, the quantity is often described as that which is equivalent to 17 grams of nitrite.

Most technical recipes for azo dye preparation call for 1 gram mole or 1 kilogram mole of an amine, since then the quantities of nitrite, acid, and alkali to be used are always the same. Hence, to the technical chemist, the expression: "the yield corresponds to 35 grams of nitrite," means that the actual yield is about 50 per cent.

The filtrate, having a volume of about 2300 cc., is transferred to a dish, heated to boiling (125°), and held at this temperature for 4 hours* (replacing the evaporated water), whereby the 1 sulfo group is split out:

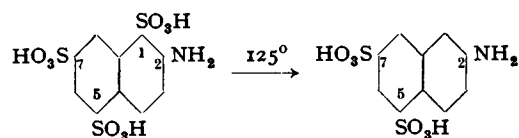

The solution is held for 2 days at 0° during which the 2,5,7 acid separates. The product, after filtering and pressing, weighs about 170 grams. The mother liquor, which is about 40 per cent sulfuric acid, contains about 22 grams of sulfonic acids per liter, which is not recovered. The 2-naphthylamine-5,7-disulfonic acid corresponds to about 26 grams of NaNO_2 .

The filter cake of the 2,6,8 acid is dissolved in 700 cc. boiling water and treated with 70 grams of salt. The voluminous precipitate of the monosodium salt of the pure acid makes the mixture almost solid. After 12 hours, the mass is broken up and filtered. The crude 2,5,7 acid is dissolved in 850 cc. hot water and reprecipitated in the same way with 85 grams of salt.

The two pure sulfonic acids are distinguishable by their very characteristic fluorescence, which is blue for the 2,6,8 acid and green for the 2,5,7 acid. The latter is clearly observable only with a very pure product and is masked by a small amount of the 2,6,8 acid. Furthermore, the two acids behave differently with an acetic acid solution of diazotized *p*-nitroaniline. The 2,6,8 acid gives, in dilute solution, only a light yellow coloration due to a diazoamino compound. The 2,5,7 acid, on the other hand, yields a red azo dye immediately. In either case, it is possible to estimate the purity of the product from the depth of color formed. The diazotized 2,6,8 acid couples with R salt to give a difficultly soluble, red azo dye which precipitates even in highly dilute solution and which dissolves on boiling to give a red color. The 2,5,7 acid, under the same conditions, yields an orange red dye which is very easily soluble.

* The solution can also be heated under reflux.

(b) 2-Amino-8-naphthol-6-sulfonic Acid (*Gamma Acid*)

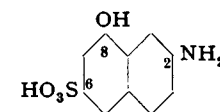

Alkali fusion of pure naphthylaminedisulfonic acids offers no difficulty, although it is desirable that the material be as free from salts as possible. Pure, dry 2-naphthylamine-6,8-disulfonic acid in an amount equivalent to 35 grams of nitrite (or the corresponding amount of moist material), 220 grams of chlorate-free sodium hydroxide, and 120 grams of water are heated in an autoclave (with stirrer) for 7 hours at $205\text{--}210^\circ\text{C}$. The pressure increases to 14 atmospheres. After cooling, the pressure is released and the contents of the autoclave are diluted to 1 liter with water (the solution should not smell strongly of ammonia), and made strongly acid with concentrated sulfuric acid. About 250 grams of acid is required. The mixture is filtered after several hours, and the precipitate washed thoroughly with cold water. The γ acid is quite insoluble in water. It is pressed out and dried at 100° . The yield is about 105 grams (equal to 95 grams of pure material), or about 80 per cent of the theoretical amount.

γ acid is analyzed by titration of its strongly alkaline solution with 1 *N* diazobenzene solution and by titration with nitrite (diazotization) in very dilute mineral acid solution. (General procedures for such analyses are given in the Analytical Section.) The values obtained in the two titrations should agree within 1 per cent (also in the case of H acid). If the fusion was conducted at too low a temperature, the nitrite titration gives a higher value than the titration with diazotized aniline. The γ acid should be at least 91 per cent pure.

(c) 2-Amino-5-naphthol-7-sulfonic Acid (*J Acid, iso-Gamma Acid*)

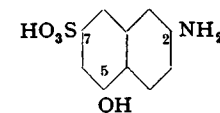

The procedure is quite similar to that given above for γ acid except that it is desirable to use somewhat more water in the fusion mixture — 160 grams instead of 120 grams. The fusion is carried out at a slightly lower temperature, $200\text{--}205^\circ\text{C}$., for 7 hours. The yield of J acid is about equal to that of γ acid, i.e., the equivalent of 95 grams of pure material

(about 105 grams of 92 per cent acid, or 82 per cent of the theoretical amount). Thus, the yield is slightly better for the 2,5,7 acid than for the γ acid. Side reactions are not prominent in either fusion since the α sulfo group is much more reactive than the one in the β position.

The J acid prepared by the above procedure is, in general, sufficiently pure for technical purposes. The product can be purified further by salting out its sodium salt, or by converting it into its difficultly soluble, nicely crystalline zinc salt.

Technical Observations. The small amount of soda admixed with the substance to be sulfonated generates carbon dioxide and thus prevents the formation of hard lumps when the substance is added to the sulfuric acid. The procedure followed in industrial preparations is frequently somewhat different from that given here. Generally, the sulfate or the free β -naphthylamine is introduced directly into the 40 per cent oleum. The isolation of the different sulfonic acids is relatively easy in the plant, since the separation is more easily accomplished with the larger amounts of material involved. Filtration is usually done in wooden filter presses equipped with nitro filters, and the purified acids or their acid salts can be centrifuged. The various mother liquors, which are too complicated in composition to be resolved in laboratory preparations, are worked up either separately or combined, according to their degree of purity. In this recovery, the liquors are completely neutralized with soda and evaporated in multiple evaporators in vacuum until sodium chloride separates. This is removed by centrifuging, and the mother liquor is then returned to the process. In disulfonations of this sort, part of the substance is always lost. Some of this loss is due to decomposition, and some is caused by the formation of easily soluble sulfones or sulfamides which are recognizable by their yellow color.

γ acid and J acid, along with H acid, are the most important aminonaphthol derivatives in the azo dye industry. They are all used in huge quantities in the preparation of wool and cotton dyes. γ acid is used today in such large amounts that it is manufactured not only from β -naphthylamine, but also from G acid. J acid has become more important recently and may soon reach the importance of γ acid, since the azo dyes prepared from it and its numerous derivatives (see Tables XIII and XIV) have very good properties. They are characterized by especially good affinity for cotton, give pure tints, and have, in part, excellent light fastness (see benzo light blue 2GL, page 279 ff.).

The two other methods for the preparation of γ acid are described briefly and schematically in the following paragraphs.

1. From 2-Naphthol-6,8-disulfonic Acid

G salt is converted to amino-G acid by heating with 25 per cent ammonia and ammonium sulfite at 140°C. (pressure, 20 atmospheres). The procedure involves nothing of special interest. A yield of 92 per cent of the theoretical amount is easily attained, and after blowing off the ammonia, the whole reaction mass is fused with caustic.

2. From G Acid and 2,8-Dihydroxynaphthalene-6-sulfonic Acid

G acid is subjected to fusion with NaOH and a small amount of water at 200° in an open vessel to yield 2,8-dihydroxynaphthalene-6-sulfonic acid. This product

is not isolated, but is treated directly with ammonium sulfate, neutralizing part of the free alkali with sulfuric acid.

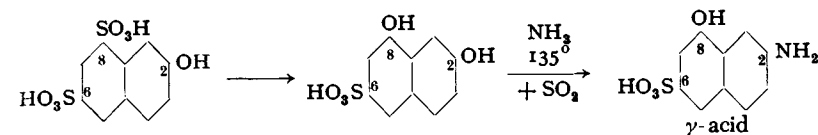

This process gives a very satisfactory product and has the advantage that pressures higher than 15 atmospheres are not required. It is noteworthy that the β -hydroxyl group, and not the α -group, is aminated (cf. page 182).

This process involves the same reactions used in the process above, but in reverse sequence; alkali fusion first, followed by the Bucherer reaction. In this case, aqueous ammonia is not used, but instead the inexpensive ammonium sulfate which is decomposed by the alkali in the fusion mixture to generate ammonia. Furthermore, the sulfite formed in the fusion reaction is enough to effect the Bucherer reaction.

Phenyl-gamma Acid

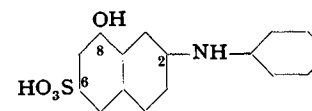

A mixture of 239 grams of 100 per cent γ acid, 750 cc. water, 750 grams of sodium bisulfite solution containing 25 per cent SO_2 , and 200 grams of aniline is boiled under reflux for 24 hours. Concentrated soda solution is then added to make the solution distinctly alkaline, and the aniline is removed by steam distillation. On acidification with concentrated hydrochloric acid, the phenyl- γ acid is precipitated. The yield is about 270 grams of 90 per cent product, or 75 to 80 per cent of the theoretical amount.

16. 1-Naphthylamine-3,6-disulfonic Acid (Freund Acid)

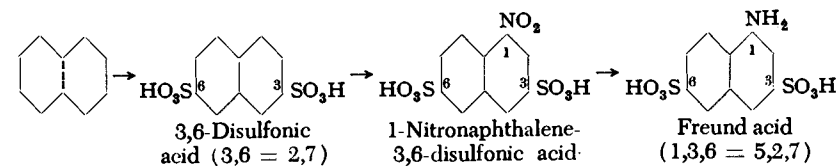

In the apparatus described on page 101, 128 grams of pure naphthalene is heated to 165°C. with stirring. During the course of 15 min-

utes, 400 grams of 100 per cent sulfuric acid is added, and the mixture is heated for 1 hour at 165°C. to complete the disulfonation. It is not advisable to heat above 165°, or as much as 30 per cent of the 2,6-disulfonic acid is formed and this gives a product quite similar to that from the 2,7 (3,6) isomer.

It is relatively simple to determine the extent to which a sulfonation reaction has proceeded. The reaction mixture is neutralized with barium carbonate and treated with enough soda to form the sodium salt. The number of sulfo groups present can be calculated from the amount of soda used up. One sulfo group requires 53 grams of Na₂CO₃. Calcium carbonate cannot be used for this purpose since calcium sulfate is soluble in solutions of naphthalenesulfonic acids.

The reaction mixture is now cooled to 15°C., and 103 grams of 62 per cent nitric acid (40° Bé) is added over a period of 1 hour, keeping the temperature below 30° since dinitro compounds are easily formed. The solution is held at room temperature for at least 10 hours and is then poured into 1 liter cold water with stirring. The resulting mixture is heated to 70°, and a stream of air is bubbled through it until no more nitric acid oxides are given off. The excess nitric acid is then destroyed by the addition of ferrous sulfate, exactly as was done in the preparation of Cleve acids (page 185), and 150 grams of anhydrous sodium sulfate (or the corresponding amount of the hydrated salt) is added to form the sulfonate. The succeeding steps of removing excess sulfuric acid by means of chalk (about 400 grams), filtering off the calcium sulfate, and reduction, are carried out in the same manner as in the Cleve acids preparation (page 185), with the single exception that here the iron is etched with hydrochloric acid (20 cc. concentrated acid) instead of with acetic acid.

The solution from the reduction is neutralized with soda (testing with ammonium sulfide to be sure that all of the iron has been precipitated) and filtered, then evaporated to 800 cc. and treated hot with 100 grams of potassium chloride. When the latter has dissolved, the solution is acidified at 100° with 100 cc. 30 per cent hydrochloric acid and allowed to cool. The acid potassium salt separates over a period of 12 hours, the whole mass setting to a solid. The pasty mixture is filtered on a large suction funnel with a double filter paper, rinsing the residue into the funnel with the mother liquor and washing the precipitate with 200 cc. saturated salt solution. The product is pressed out as completely as possible in a screw press. The moist press cake weighs 300 to 320 grams, about 270 grams when dry, and corresponds to about 35 grams of sodium nitrite (see page 206).

The mother liquor is dark colored and uses about 22 grams of sodium nitrite, especially if the reduction has not been carried out properly. It contains hydroxyl-

amine compounds which give a violet solution on diazotization. The sodium salt can be prepared instead of the potassium salt, by using 100 grams of sodium chloride in the precipitation. The precipitate is much more difficult to filter, however, and the final product is therefore not quite so pure as when the potassium salt is used. By dissolving the press cake in four parts of boiling water and recrystallizing, Freund acid is obtained in a very pure state, which is especially suitable for use in the preparation of complicated polyazo dyes.

17. 1-Amino-8-naphthol-3,6-disulfonic Acid (H Acid)

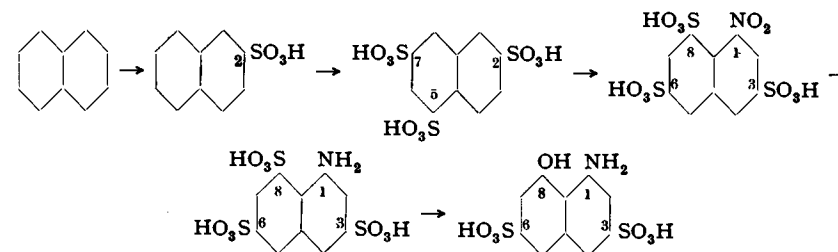

(a) 1-Naphthylamine-3,6,8-trisulfonic Acid (Koch Acid)

In an iron vessel (or a glass flask or porcelain beaker with a tight lead cover) of about 1-liter capacity, 128 grams of pure naphthalene is heated to 150°C., and 140 grams of 100 per cent sulfuric acid is added with good stirring, allowing the temperature to rise to 160–165°. The mixing is completed in 10 to 15 minutes and stirring is continued at 160–165° for 30 minutes more. The reaction mixture is then cooled to 100°, an additional 230 grams of 100 per cent sulfuric acid is added in one portion, and the whole is cooled further to 30°. While the temperature is held at this point, 400 grams of 60 per cent oleum is added in the course of 30 minutes, and the mixture is stirred at 25° for 3 hours, then for 7 hours at 165° to complete the trisulfonation (plus some unavoidable tetrasulfonation). The reaction vessel is now placed in ice water and the mixture is cooled to 10°, 15 grams of ice is added, and 103 grams of 62 per cent nitric acid (40° Bé) is added dropwise. The temperature must not exceed 10° or extensive oxidation will occur. The nitric acid can be added in about 1 hour. The reaction mixture is allowed to stand overnight, and is then poured into 2 liters cold water. Nitric oxide is given off, and the temperature may rise to 70° without damage. Air is blown through the solution for about 1 hour at 70° to remove most of the nitric oxide, the last parts of which are removed by the addition of a 20 per cent solution of ferrous sulfate (test a diluted portion of the mixture with starch-iodide paper or sulfone reagent; see page 185).

The resulting sulfuric acid solution is cooled to 30°C., and to it is added, with continuous stirring, 180 grams of iron nails in small portions. The temperature rises to about 60° in the course of 2 hours. Stirring is continued for 4 hours, and then the temperature is increased to 70° over the course of the next hour. Part of the iron goes into solution. On standing overnight, the mixture precipitates the iron salt of 1-naphthylamine-3,6,8-trisulfonic acid (Koch acid). It is then heated to 90° whereupon everything but the unused iron goes into solution. The supernatant liquid is poured off, and the acid sodium salt of Koch acid is precipitated by the addition of solid salt with thorough stirring. Enough salt is used to make the solution 18 per cent with respect to sodium chloride. The ferrous sulfate is not precipitated. The mixture is allowed to cool to 25° and is filtered without delay (because of the danger of the iron salts crystallizing) through a triple filter on a large suction funnel. The precipitate is washed thoroughly with 20 per cent salt solution to remove all of the iron salts and sulfuric acid. It is then dissolved in 1 liter hot water containing the necessary amount of soda, and the solution is filtered. The filtrate is reheated to 80°, and the Koch acid is precipitated by the addition of salt (to make the solution 18 per cent salt) and enough hydrochloric acid to produce a strongly acid reaction to Congo red. The acid sodium salt of 1-naphthylamine-3,6,8-trisulfonic acid separates as a snow-white precipitate. After 12 hours, it is filtered off and pressed out in a screw press. The yield is about 350 grams of moist press cake corresponding to about 38 to 42 grams of nitrite, or about 55 to 60 per cent of the theoretical amount.

Technical Observations. The manufacture of Koch acid is one of the most important operations in the whole field of dye chemistry, because from it are prepared two of the most widely used intermediates of the dye industry: H acid (1-amino-8-naphthol-3,6-disulfonic acid) and chromotropic acid (1,8-dihydroxynaphthalene-3,6-disulfonic acid). In large scale preparations, 2 moles (256 kilograms) of naphthalene is usually sulfonated at one time with the addition of Na₂SO₄ to ensure smooth reaction. Maintenance of the necessary temperature is rather difficult. Superheated steam is usually used for heating (Fig. 31) since this gives rapid heating, but does not prevent rapid cooling. The nitration step is especially difficult because the naphthalene-1,3,6-trisulfonic acid which is formed tends to separate, with the result that the rest of it, which remains dissolved, is easily oxidized by the nitric acid. To avoid this, the nitration is started at temperatures as high as 80°, which is much too high, of course, but does have the advantage that crystallization is prevented. After a small amount of nitric acid has been added, the mixture is cooled to 20° without risking separation of the trisulfonic acid. The other operations resemble closely those carried out in the laboratory, and no further remarks on them are necessary.

All variations of the steps in this synthesis have been studied. A few of these variations might be mentioned here. Instead of using an acid reduction, the nitration mixture can be limed and then reduced in the presence of a small amount of acid exactly as in the case of Cleve acids (page 185). The nitrotrisulfonic acid can also

be salted out easily and filtered off. This, however, offers difficulty in industrial work, since it involves working with strongly acid solutions. The sulfonation can be modified so that the intermediate product is largely naphthalene-2,7-disulfonic acid instead of the 1,6 isomer as in the procedure given here.

The 2,7-disulfonic acid can be used to prepare H acid by a different method, as shown in the following reactions:

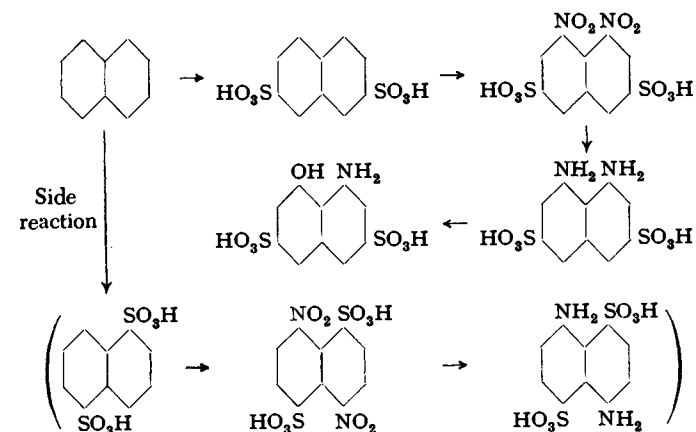

This series of reactions gives about the same yield as the process described here, but the H acid obtained is not quite so pure.

(b) 1-Amino-8-naphthol-3,6-disulfonic Acid (H Acid)

Alkali fusion of 1-naphthylamine-3,6,8-trisulfonic acid yields H acid, the most important member of this series of intermediates in the dye industry. The preparation of H acid is a typical example of fusion reactions.

In order to obtain H acid in good yields, the temperature of fusion must not exceed 190°C. and the caustic soda must be at least 30 per cent. The following proportions are recommended for a laboratory preparation:

Naphthylaminetrisulfonic acid	weight corresponding to 28 g. nitrite, or about 280 g. moist press cake
Caustic soda	130 g.
Water	130 g.

The fusion is carried out in an autoclave, an apparatus of such great importance both for the laboratory and for plant operations that a separate chapter has been devoted to its use (page 350). The ingredients listed above are placed in the autoclave and held, with continuous stirring, at 178–180°C. for 8 hours. The pressure is about 7 atmospheres.

The autoclave is then cooled and any excess pressure is released through the valve before loosening the top. If the fusion has been carried out properly, the fusion mixture is a dull, dirty yellow in color. If the color is too light, the fusion was not continued long enough. Too long a fusion, on the other hand, produces a mixture which is brown in color and which smells strongly of ammonia. Some ammonia is always formed, however, even under the correct conditions.

The reaction mixture at this point is a sirupy mass containing granular crystals of sodium sulfite. It is transferred to a 2-liter earthenware crock and diluted with 1 liter of water, and enough 50 per cent sulfuric acid is added to give the solution a definite and permanent acid reaction to Congo red. One must not be deceived by the free sulfurous acid set free in the reaction, since this volatilizes rapidly (hood!). The aminonaphtholdisulfonic acid precipitates as the acid sodium salt which is very insoluble in concentrated sodium sulfate solutions.* In spite of the low solubility of the product, the mixture should be allowed to stand several hours so that precipitation is complete. The product is then filtered off and washed with 10 per cent salt solution containing 1 per cent of hydrochloric acid. Excessive washing must be avoided to prevent loss of H acid. The material is finally pressed out in the screw press and dried at 100°. The yield is about 110 grams of 86 per cent H acid, corresponding to about 100 grams of 100 per cent material.

Concerning the analysis of H acid, see page 389.

18. 1-Naphthylamine-5- and -8-sulfonic Acids

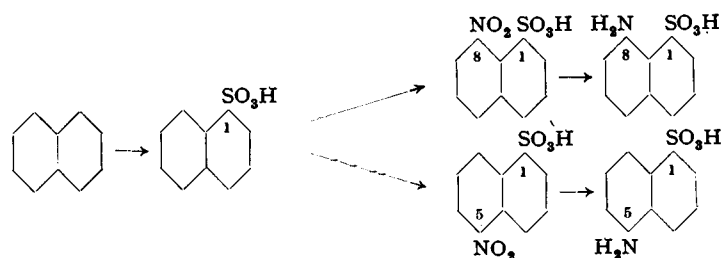

The preparations of these acids closely resembles the preparation

* Solubility of H acid:

In water at 18°	0.93%
In 10% NaCl at 18°	0.053%
In 10% NaCl + 0.8% HCl at 18°	0.023%
In water at 100°	8%

of Cleve acids. The two acids are among the most widely used intermediates.

The most favorable conditions for preparing naphthalene- α -sulfonic acid involve sulfonating at a temperature (below 80°C.) lower than the melting point of naphthalene. To 260 grams of 100 per cent sulfuric acid, cooled to 0°, 128 grams of finely powdered naphthalene is added rapidly. (96 per cent of the powdered material should pass through a sieve having 400 openings per square centimeter. See page 175.) Sulfonation commences at once, and unless steps are taken to prevent it, the mixture will set up suddenly to a very hard mass when the crystals of naphthalenesulfonic acid separate. When this happens, the stirrer is incapable of continuing. This occurrence can be prevented by seeding the mixture with a small amount of the solid sulfonic acid as soon as the introduction of the naphthalene has been completed. The seed crystals can be prepared by warming a small amount of naphthalene with sulfuric acid on a water bath and then cooling the mixture. The seed crystals induce rapid crystallization of the sulfonic acid as fast as it is formed and prevent its crystallization from a supersaturated solution. The sulfonation mixture thickens more slowly, and a sudden solidification does not occur.

The temperature seldom rises above 35°C., and it is necessary to use pure 100 per cent sulfuric acid or part of the naphthalene is not attacked. This is frequently the case in any event, so the mixture is warmed on a water bath to 60° with continuous stirring until all of the naphthalene has disappeared. It is difficult, without considerable practice, to effect smooth sulfonation on a small scale, although no undue difficulties are encountered in large scale sulfonations. To test for the presence of residual naphthalene in the reaction mixture, a small sample is diluted with water. Any unsulfonated naphthalene separates immediately.

The nitration reaction is carried out in exactly the same way as in the preparation of Cleve acid, except that here the second addition of sulfuric acid is unnecessary since it was all added at the beginning. The reduction step and isolation of the two isomeric naphthylaminesulfonic acids are also carried out as described for Cleve acids. The sodium salt of the 1,8 acid is, however, still less soluble than that of the 1,7 acid, and the isolation is therefore easier. The 1,8 acid obtained is practically free from Cleve acids, although a small amount is always present despite the low sulfonation temperature used. The yield of 1,8 acid is equivalent to about 100 grams of 100 per cent material; that of the 1,5 acid, obtained

by precipitation with sulfuric acid, is equivalent to about 40 grams of 100 per cent material.

Variation: 1-Naphthylamine-5- and -8-sulfonic acids differ from the other sulfonic acids in that they can be isolated in the presence of large amounts of iron salts. Instead of neutralizing with lime and reducing the magnesium salt, the nitro acid, diluted with water, can be reduced directly with iron turnings. A necessary condition, however, is that the solution must be kept neutral to Congo red at all times. The temperature rises to about 80°C., and none of the sulfonic acid separates out. The mixture is heated to boiling for a considerable period, the violet coloration gradually changing to a greenish one. Boiling is continued while 40 grams of iron powder is added gradually, and the ferrous salts of the 1,5 and 1,8 acids separate as grayish white crystals. These salts are decomposed, after cooling the mixture, by the addition of sulfuric acid to make the solution definitely acid. The free sulfonic acids are then filtered off, washed thoroughly to remove iron sulfate, and the residue is dissolved in 1 liter of water containing 40 grams of magnesium carbonate. The solution is filtered and salt is added to make the solution 4 per cent with respect to salt. The 1,8 acid is precipitated as the sodium salt in extremely pure form, completely free from Cleve acids. After filtering off the sodium salt of the 1,8 acid, the filtrate gives the pure 1,5 acid on acidification. In this process, the Cleve acids are reduced to the hydroxylamine stage and then rearranged to the 1,4-aminonaphtholsulfonic acids which are washed out along with the iron sulfate.

Technical Observations. In large scale operations, the sulfonation of powdered naphthalene must be carried out somewhat differently than in the laboratory. In the first place, it is essential that the naphthalene be freshly ground because it soon reagglomerates. The best practice is to grind the material once on the day before it is to be used, and then again immediately before use, or if necessary, twice more. The addition of naphthalene to the sulfuric acid must be made as rapidly as possible. A good practical method of making this addition is to put all of the naphthalene into an open box and rake it from this into the opening in the sulfonation vessel. The material should be passed through a coarse sieve with a funnel-shaped bottom to prevent any lumps from getting into the reaction mixture. When all of the naphthalene has been added, the mixture is seeded and stirred up well with an iron spatula. An anchor-type stirrer is used, similar to the one shown in Figure 31. Even with very efficient cooling, the temperature of the pasty mixture rises slowly to about 18°C. and then suddenly to about 58° due to the heat of crystallization. Since these sulfonation conditions are more vigorous than in the laboratory preparation, the sulfuric acid should be diluted with ice to about 98 per cent. The sulfonation is completed in about 1.5 hours if the naphthalene was powdered finely enough.

If the alternate procedure is used, an iron reduction vessel cannot be used of course. For this process, wooden vats are used, and they last a long time.

The free sulfonic acids, after precipitation with sulfuric acid, are filtered off in filter presses having felt filters. The better the precipitate is washed, the easier will be the extraction with magnesia. It is advisable to wash the residue from the filtration at least twice with hot water since the magnesia-iron sludge retains appreciable quantities of the sulfonic acids.

The 1,8 acid cannot be precipitated in large scale operations by the addition of solid salt. Instead, a salt solution is added over a period of an hour, in order to prevent carrying down part of the 1,5 acid.

1-Naphthylamine-8-sulfonic acid is not used directly in making dyes, but only after conversion to other compounds, the most important of which are: naphthsultone, 1-phenylaminonaphthalene-8-sulfonic acid, 1-amino-8-naphthol-4-sulfonic acid, and 1-amino-8-naphthol-2,4-disulfonic acid. The preparations of these compounds is shown in the following reactions:

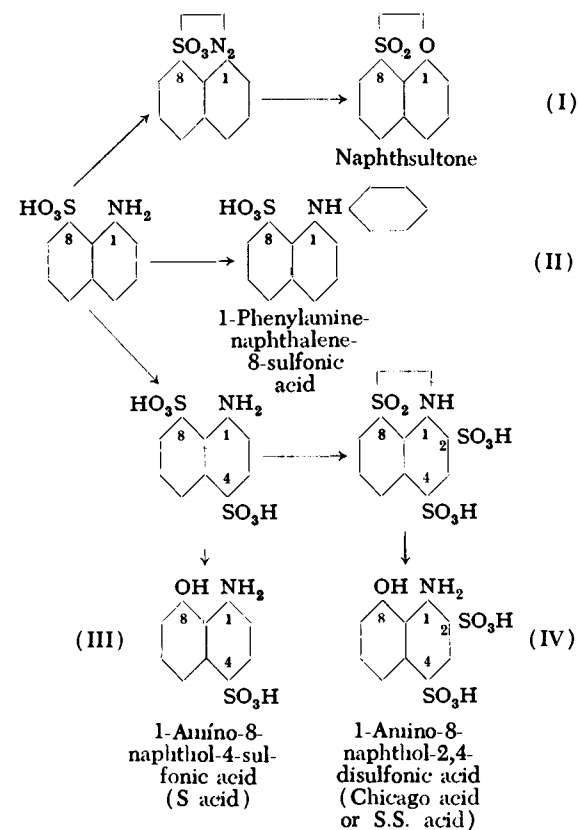

1-Naphthylamine-8-sulfonic acid can be converted into the diazonium compound by treatment with nitrous acid (sodium nitrite) in mineral acid solution at

25°C. When the diazonium compound is heated to 55° in water solution, the naphthsultone (I) is formed in quantitative yield. The amount of the sultone formed is a direct measure of the purity of the starting material. The naphthsultone is almost always converted to the naphthsultonesulfonic acid, which yields very pure and light-fast dyes with diazo compounds. These dyes have decreased greatly in importance in recent years.

1-Naphthylamine-8-sulfonic acid can also be converted to arylated products. Thus, the free sulfonic acid, when heated with aniline and aniline hydrochloride, yields the technically important 1-phenylaminonaphthalene-8-sulfonic acid (II). One part of the pure, free sulfonic acid, mixed with three parts of aniline (or *p*-toluidine) and aniline (or *p*-toluidine) hydrochloride, is heated to 160°C. in an enameled kettle in an oil bath. The water which is always present is removed by vacuum distillation, and the heating is continued for 24 hours with stirring. The excess aniline is then removed by careful vacuum distillation, after which the aniline salt of the phenylated acid is decomposed by the addition of the calculated amount of hydroxide solution, and the remaining aniline is removed by steam distillation. The resulting solution, containing the desired phenylaminonaphthalenesulfonic acid, is coupled directly with H acid in acetic acid, without first isolating the phenylated sulfonic acid. The dye prepared in this way is sulphon acid blue R, which is fast to light.

Sulfonation of 1-naphthylamine-8-sulfonic acid with oleum gives, depending on the conditions, either the di- or trisulfonic acid of naphthylamine (as well as the naphthsultamidisulfonic acid⁶⁶). Alkali fusion of these compounds yields the corresponding aminonaphtholsulfonic acids (III and IV), which are starting materials for wool and cotton dyes.

1-Naphthylamine-5-sulfonic acid is less important and deserves but little comment. It is either diazotized and coupled with amines and naphthols, or converted to 1-amino-5-naphthol-7-sulfonic acid (M acid). As shown by the reactions:

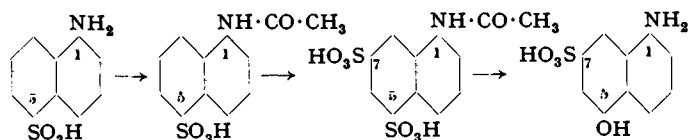

it is necessary to acetylate the naphthylaminesulfonic acid first (in contrast to the 1,8 isomer), because it would otherwise be destroyed by the sulfuric anhydride. Such acetylations are rather widely used in the dye industry (see amidonaphthol red G).

⁶⁶ Wielopolski, *Dissertation*, Zürich-Linz, 1936.

19. 1-Aminonaphthalene-4,8-disulfonic Acid, 2-Aminonaphthalene-4,8-disulfonic Acid, and 1-Aminonaphthalene-3,8-disulfonic Acid

To 900 grams of 100 per cent sulfuric acid, cooled to 5°C., is added, over a period of 15 minutes with good stirring, 384 grams of pure powdered naphthalene. Stirring is continued for 30 minutes and then 900 grams of oleum (64 per cent SO₃) is added slowly, not allowing the temperature to rise above 30°. When all of the oleum has been added, the mixture is warmed slowly to 40° and stirring is continued for 8 hours at this temperature.

10 grams of water is added, and then 305 grams of 62 per cent nitric acid (40° Bé) is added dropwise. The nitration temperature is 15–20°. The mixture is allowed to stand overnight and is then poured into 3.5 liters of water.

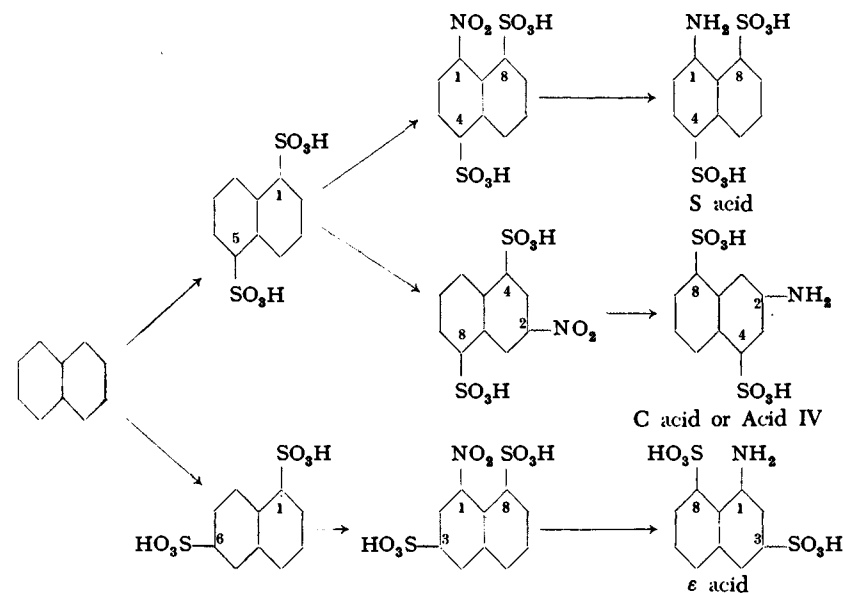

Several methods can be used for working up the reaction mixture. The mixture can be limed and reduced by the Béchamp method (pages 75 and 77), or the nitro acids can be salted out with 1250 grams of salt. Another method consists in precipitating the 2-nitronaphthalene-4,8-disulfonic acid with 200 grams of ferrous sulfate, filtering it off, and liming the mother liquor. Subsequent steps resemble those for Cleve acids, except that no magnesia is used. If the 2-nitronaphthalene-

4,8-disulfonic acid is precipitated with ferrous sulfate, the precipitated acid and the limed mother liquor are reduced by the Béchamp method. The resulting reduced solutions are then evaporated to the point where they contain 20 per cent solids.

The 1-aminonaphthalene-4,8-disulfonic acid is precipitated as the neutral sodium salt by the addition of enough salt to make a 20 per cent salt solution (30° B \acute{e}). The sulfonate is then filtered off. The 1-aminonaphthalene-3,8-disulfonic acid is precipitated with hydrochloric acid as the acid sodium salt. If the whole mixture was limed, then the mother liquor is neutralized and evaporated to the point where salt separates. The supernatant liquid is poured off and allowed to crystallize at 20°C. The neutral sodium salt of 2-aminonaphthalene-4,8-disulfonic acid separates. This neutral salt is dissolved in water (24° B \acute{e} solution) and precipitated by making the solution acid to Congo red with concentrated hydrochloric acid. The mixture is then allowed to cool, and the product is filtered off.

Depending on the method used, approximately the following yields are obtained: TOTAL YIELD, 55 to 68 per cent of the theoretical amount; of this, about 70 per cent is the 1,4,8 compound, about 16 per cent the 1,3,8 compound, and 14 per cent the 2,4,8 compound. In addition, other isomers are formed, such as the 1,4,7 and 2,4,7 compounds. These are, however, difficult to separate from the 2,4,8 isomer.⁶⁷

It is remarkable that yields higher than about 70 per cent of product titratable with nitrite are never obtained even in the most carefully executed preparations, even though all of the nitric acid is used (nitrometer determination). The reason must be that, in this case as well as in others, some of the amine is destroyed in the reduction. As in the preparation of H acid and the other naphthylaminesulfonic acids, it is always necessary to destroy the residual nitric acid before the reduction (see page 185).

The above sulfonic acids are important starting materials for preparing azo and other dyes (wool fast blue BL).⁶⁸

1-Naphthylamine-4,8-disulfonic acid can be converted by alkali fusion into 1-amino-8-naphthol-4-sulfonic acid (S acid). It can also be sulfonated further and the resulting sultam converted to the valuable Chicago acid. 1-Naphthylamine-3,8-disulfonic acid can be converted into 1-naphthol-3,8-disulfonic acid by heating the acid sodium salt with water to 180–200°C. Finally, 2-naphthylamine-4,8-disulfonic acid is used in preparing direct dyes, e.g., naphthogene blue RR.⁶⁹ The following reactions, and Table XI, show these various transformations.

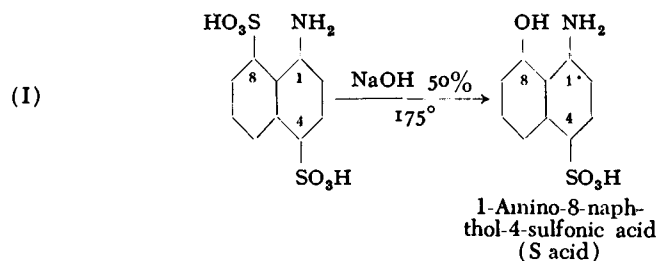

⁶⁷ Edlmann, *Dissertation*, Zürich, 1925.

⁶⁸ Fierz-David, *Künstliche organische Farbstoffe*, Springer, Berlin, 1926, p. 332.

⁶⁹ Fierz-David, *Künstliche organische Farbstoffe*, Springer, Berlin, 1926, p. 160.

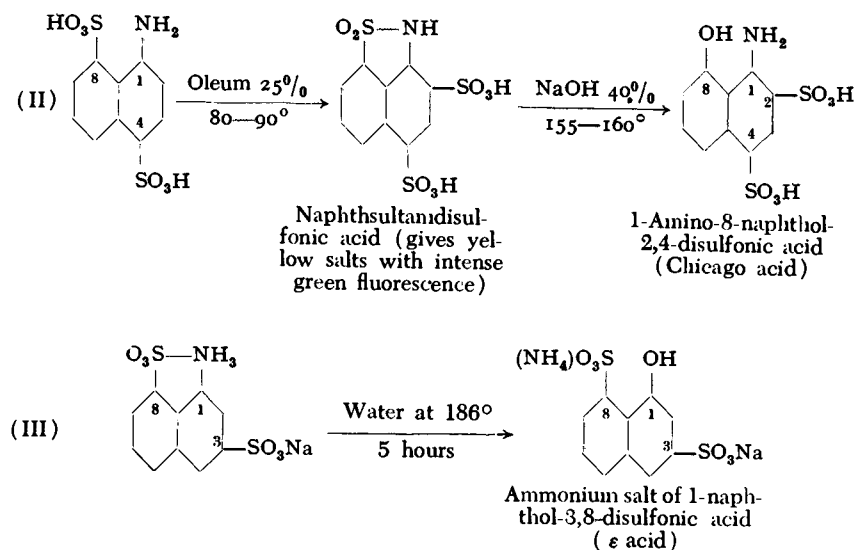

20. Naphthalene-1,4,5,8-tetracarboxylic Acid from Pyrene

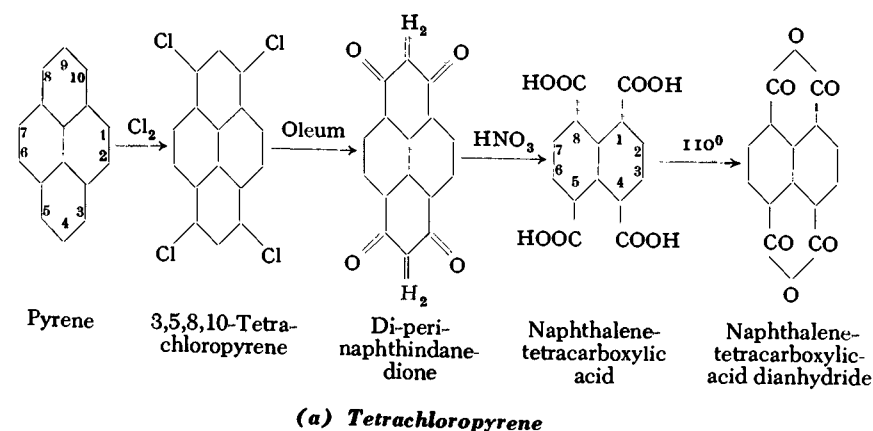

In a moisture-tight, three-necked flask provided with stirrer, thermometer, and reflux condenser, 101 grams (0.5 mole) of pyrene is dissolved at 130°C. in 1500 grams of dry trichlorobenzene (or dichlorobenzene). A stream of dry chlorine is introduced with vigorous stirring

until the increase in weight reaches 65 grams. Toward the end of the reaction, the tetrachloropyrene separates and the reaction mixture becomes a thick paste. The endpoint of the chlorination can also be determined by following the melting point of the separated tetrachloropyrene; in this case, the chlorination is stopped when the melting point of the product is 355° (corrected). The mixture is then allowed to cool and is filtered with suction, washing the product with benzene and drying it in a steam heated oven. The yield is 130 grams of crude chloropyrene. A pure product can be obtained in the form of colorless needles (m.p. 368°), by recrystallizing from a large volume of nitrobenzene.

(b) Naphthalenetetracarboxylic Acid

In a three-necked flask, provided with calcium chloride tube, dropping funnel, and thermometer, the 130 grams of chlorination product from above is stirred with 2400 grams of 20 per cent oleum for 1 hour at 100°C. The mixture is then cooled to 70°, 1300 grams of concentrated sulfuric acid is added, and the solution is heated to 120° for 30 minutes. The resulting reddish brown solution is again cooled to 70°, and 260 grams of nitric acid (sp.g. 1.52) is added over a period of 1 hour. The temperature rises from 70 to 130° and nitric oxides are given off. At the end of the reaction, the solution is heated for a short time at 160°, during which it becomes much lighter in color. The mixture is cooled, poured into 10 liters of water (copious evolution of nitric oxide), and allowed to stand overnight. The yellowish product is filtered off, washed with water, and taken up in 1 liter of 2 *N* soda solution which dissolves almost all of the material. The brownish yellow solution is treated with animal charcoal, heated briefly, and filtered. Acidification of the filtrate with concentrated hydrochloric acid precipitates pure, white naphthalenetetracarboxylic acid, which is converted to its anhydride by drying for 3 hours at 110°. The yield is 60 to 70 grams, or 45 to 52 per cent of the theoretical amount based on pyrene.

Technical Observations. Naphthalenetetracarboxylic acid is obtained most easily — analogously to phthalic acid — by oxidation of the corresponding higher ring system, pyrene. Instead of first chlorinating the pyrene, it can be oxidized by dichromate and sulfuric acid to form pyrenequinone (mixture of the 3,8 and 3,10 quinones) and this can then be oxidized further to naphthalenetetracarboxylic acid by chloride of lime in the presence of lime, according to the reaction:

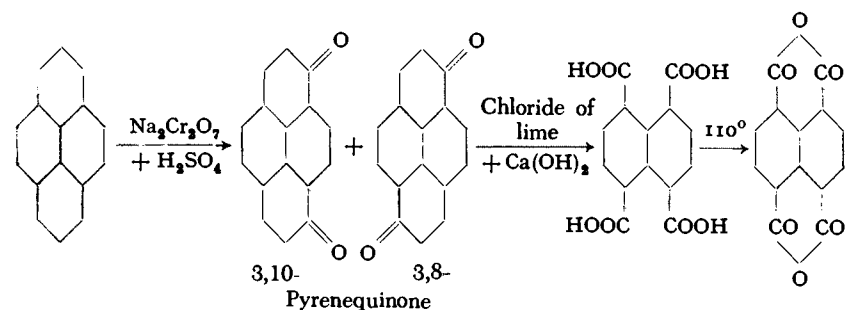

This procedure is more suitable for large scale operation, giving a yield about equal to that of the first process.

Naphthalenetetracarboxylic acid and its anhydride react, similarly to phthalic anhydride, with *o*-diamines to form intensely colored bis-imidazoles. These compounds, in contrast to the corresponding derivatives of phthalic anhydride, have the properties of vat dyes. When *o*-phenylenediamine is used, a mixture of the two isomers, I (*cis*) and II (*trans*), is formed. This mixture is known in the trade as indanthrene scarlet 2C. The *trans* isomer (II), isolated from the mixture, is known as indanthrene brilliant orange GR.

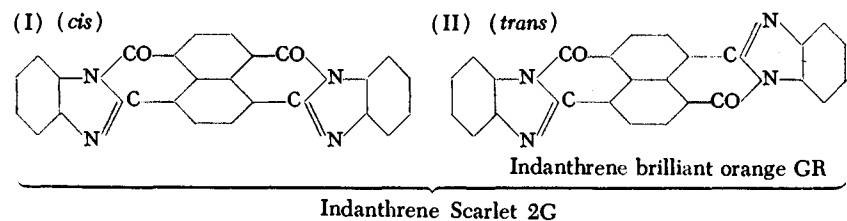

Pyrene is one of the high molecular hydrocarbons which have been isolated, in recent years, on a commercial scale from the highest boiling fractions of coal tar (and also from the products of coal hydrogenation).⁷⁰ This new starting material has rapidly found a widespread use,⁷¹ particularly in the synthesis of vat dyes. Thus, 3,8-dibenzoylpyrene, on heating with aluminum chloride,⁷² yields pyranthrone, which was formerly prepared from β -methylantraquinone:

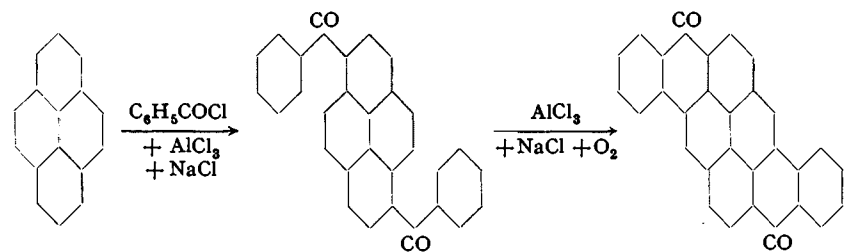

⁷⁰ O. Kruber, *Ber.*, 64, 84 (1931). Pier and Schoenemann (I.G.), Ger. Pat. 639,240 (1936) [*C.A.*, 31, 1590 (1937)] and 640,580 (1937) [*C.A.*, 31, 5543 (1937)].

⁷¹ Vollmann, Becker, Corell, and Streeck, *Ann.*, 531, 1-159 (1937).

⁷² Kränzlein, *Z. angew. Chem.*, 51, 373 (1938).

Benzopyrenequinone, which also contains the pyrene nucleus, and which is a valuable vat dye, is not prepared from pyrene, but from benzanthrone.

C. COMPOUNDS OF THE ANTHRAQUINONE SERIES

21. Anthraquinone

Method 1: Oxidation of Anthracene⁷³

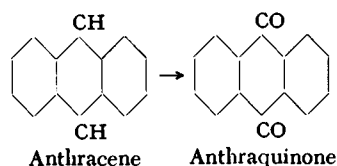

Impure anthracene should not be used in the preparation of anthraquinone, since too much chromic acid is required. The product now produced by coal tar distillation varies in purity from 80 to 92 per cent, the value for any given sample being determined by well known methods.⁷⁴ The commercial product is always crystallized from pyridine bases.

Before oxidation, the anthracene must be sublimed with superheated steam at about 200°C. This is the only process which yields a product in a sufficiently high state of subdivision.

In a large lead-lined vessel, 300 grams of sublimed, still moist, anthracene (calculated on the basis of 100 per cent product) is stirred with 6 liters of water and 600 grams of sodium bichromate. The mixture is heated to 80°C. over a Fletcher burner, and 1800 grams of 50 per cent sulfuric acid is added over a period of 10 hours. Chromic acid should always be present, and the mixture should be stirred with a wooden or glass rod. Finally, the mixture is boiled for 2 hours, replacing the water lost by evaporation. The precipitate is then filtered off and washed thoroughly. The mother liquor can be worked up to recover chrome alum or chromic sulfate.

⁷³ See also, R. Gnehm, *Die Anthracenfarbstoffe*. Vieweg, Braunschweig, 1897.

⁷⁴ Lunge and Berl, *Chemische-technische Untersuchungsmethoden*. 8th ed., Springer, Berlin, 1931.

The crude anthraquinone contains some unchanged anthracene and other impurities and must be purified before use. Purification is effected by partial sulfonation and distillation with superheated steam.

The pulverized, dry crude anthraquinone is heated at 120°C with 2.5 times its weight of 66° Bé sulfuric acid until no more sulfur dioxide is formed. This usually requires about 3 hours. The mixture is allowed to cool to 80° and enough water is added, over a period of 1 hour, to dilute the sulfuric acid to 30 per cent. This procedure causes the anthraquinone to separate in an easily filterable form, whereas if the sulfonation mixture is poured into water, a slimy precipitate is formed which is impossible to filter. The diluted mixture is cooled and filtered and the precipitate is washed thoroughly with water. The product is then sublimed with steam at 240–260°. (Apparatus, see Figs. 23 and 24). If it appears necessary, the purification operation can be repeated. In this case, the sulfuric acid should be only very slightly colored. The purified anthraquinone is obtained as a fine powder having a weak yellow green color. The yield from 100 grams of pure anthracene is about 106 grams of 100 per cent anthraquinone.

Technical Observations. The industrial oxidation of anthracene is carried out in lead-lined wooden or iron vessels of very large size. Vats of 15,000- to 25,000-liter capacity are not unusual. The chromic sulfate obtained as a by-product is an important consideration in the process, since it is used in large quantity in the chrome tanning of leather and cannot be produced as cheaply in any other way. Because of the demand for chromic sulfate, anthraquinone is still produced, in great measure, by chromic acid oxidation despite the fact that anthracene can be oxidized satisfactorily on an industrial scale by other reagents, such as nitrous oxides and air, or simply by air alone in the presence of a vanadium catalyst. The latter method is used today to produce a significant amount of anthraquinone. If chrome tanning is ever replaced by tanning with synthetic tannins, the chromic acid oxidation method will certainly disappear.

Distillation of anthracene and anthraquinone is carried out in apparatus quite similar to that used for diphenylamine (page 142). The steam is condensed in large chambers (about 3 x 3 x 5 m.), in which cold water is sprayed. The bottom of the chamber consists of a fine calico screen which retains the sublimate and allows the water to pass through.

Method 2: From Phthalic Anhydride and Benzene

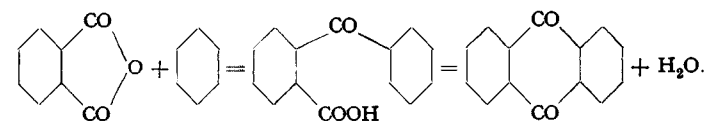

(a) *o*-Benzoylbenzoic acid

In a 3-necked flask fitted with stirrer and thermometer are placed

148 grams (1.0 mole) of phthalic anhydride, which must be completely free from phthalic acid,* and 520 grams of thoroughly dried benzene. To this solution is added, in one portion, 267 grams (2 moles) of anhydrous aluminum chloride (this amount of AlCl_3 is necessary to prevent the formation of diphenylphthalide) which is broken up into pea-sized lumps. A reflux condenser fitted with a calcium chloride tube is then attached, and the mixture is warmed slowly to 70°C . with continuous stirring and held at this temperature until no more hydrogen chloride is generated. The mixture is then poured with stirring (foam!) into a solution of 400 grams of soda ash in about 2.5 liters of water, and the excess benzene is removed by steam distillation. The mixture should now be alkaline, and if not, more soda is added. The precipitated aluminum hydroxide is filtered off from the hot solution and washed with hot water, then heated again with about 1 liter water, filtered, and again washed until a portion of the washings gives no precipitate on the addition of acid. The combined filtrate and washings are made strongly acid to Congo red with concentrated hydrochloric acid. After cooling, the precipitated benzoylbenzoic acid is filtered off, washed with water, and dried. The yield is 215 to 220 grams, or 95 to 97 per cent of the theoretical amount.

(b) Anthraquinone

The dried benzoylbenzoic acid, obtained above, is dissolved in 6 parts of 66° Bé sulfuric acid and heated for 1 to 2 hours at 150°C . The solution is cooled and poured into water, and the precipitated anthraquinone is filtered off and washed thoroughly with hot water. Any residual benzoylbenzoic acid is removed by washing the precipitate with soda solution. The product is then washed with water and dried. The yield is almost quantitative.

β -Methyl- and β -chloroanthraquinone are prepared in the same way by using toluene and chlorobenzene, respectively, instead of benzene in the foregoing procedure (see next preparation, and also page 58). When chlorobenzene is used, it is recommended that the aluminum chloride be added gradually at 40 – 50°C . with stirring, and the temperature then raised to 80° and held at this point until the evolution of hydrogen chloride ceases.⁷⁵

* The phthalic anhydride should be tested by heating a sample in a test tube. If the material does not produce a clear melt without formation of gas, it must be dehydrated by heating it carefully in a porcelain dish until a perfectly clear, nonfoaming melt is formed. The melt is then cooled in a desiccator.

⁷⁵ Murch (Nat. An. & Chem. Co.), U.S. Pat. 1,746,736 (1930) [C.A., 24, 1651 (1930)].

22. 1-Amino-2-methylanthraquinone⁷⁶

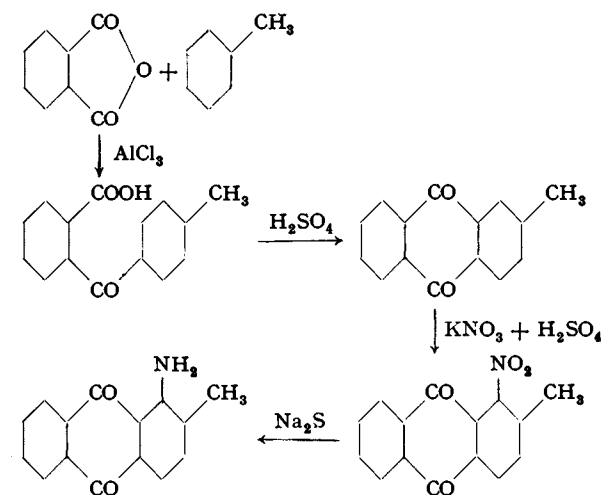

(a) 2-Methylanthraquinone

The condensation of toluene with phthalic anhydride takes place in the presence of aluminum chloride even at room temperature and is complete after about 12 to 15 hours of stirring. The ring closure can be effected with 5 per cent oleum (10 parts for 1 part of toluylbenzoic acid) by heating on a water bath for 2 hours. Usually, however, the preparation is done exactly as described for the preparation of anthraquinone from phthalic anhydride and benzene. The yield of 2-methylanthraquinone, melting at 170 – 174°C ., is about 85 to 88 per cent of the theoretical amount calculated on the phthalic anhydride.

(b) 1-Nitro-2-methylanthraquinone

In a round-bottomed flask equipped with a stirrer, 100 grams of 2-methylanthraquinone is dissolved in 900 grams of 66° Bé sulfuric acid. The solution is cooled in an ice-salt bath to 0°C . and 50 grams of finely powdered potassium nitrate is added slowly with vigorous stirring. The temperature should be held as near 0° as possible, and must not rise above 5° in any case or appreciable amounts of higher nitration products and oxidation products will be formed. The nitro compound precipitates gradually in the form of microscopic needles. After stirring for 15 hours at 0° , the reaction mixture is poured onto 5 kilograms of ice, and the

⁷⁶ Locher and Fierz-David, *Helv. Chim. Acta*, 10, 642 (1927).

precipitated, light yellow product is filtered off and washed with water until all of the acid has been removed.

Purification of the crude product is carried out by boiling it for 6 hours, without previous drying, under reflux with a solution of 100 grams of sodium sulfite in 1 liter water. This treatment does not affect the 1-nitro-2-methylantraquinone, but isomeric compounds go into solution because, with them, the nitro group is replaced by a sulfo group. The mixture is filtered hot, and the residue is washed with hot water until the wash water, which is dark brown at first, is colorless. After being dried, the product weighs about 98 grams (82 per cent of the theoretical amount), and is in the form of fine, light gray crystals melting at 265–267°C. The material is free from isomeric compounds and is sufficiently pure for most purposes. It contains traces of unchanged methylantraquinone which is easily removed by extraction with alcohol. The product, after this treatment, is chemically pure and melts at 269–270°.

(c) 1-Amino-2-methylantraquinone

The moist filter cake of nitromethylantraquinone, obtained after the purification with sulfite, is placed in a solution of 200 grams of crystalline sodium sulfide in 2 liters water, and the mixture is boiled under reflux for 2 hours. The mixture is then filtered hot, and the precipitate is washed with hot water until the washings are colorless. The product is pressed out as dry as possible and dried at a moderate temperature (about 80°C.) in order to avoid loss by sublimation. The yield is about 85 grams (97 per cent) of material melting at 198–200°. A chemically pure product, melting at 201–202°, can be obtained by one recrystallization from toluene.

23. 2-Aminoanthraquinone

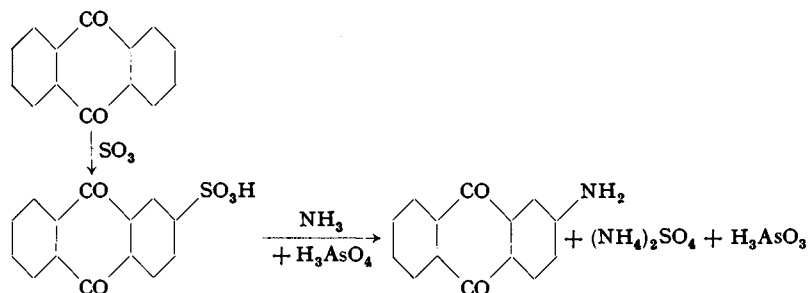

(a) Sodium Anthraquinone-2-sulfonate ("Silver Salt")

To 125 grams of oleum containing 18 per cent SO_3 is added, with stirring, 100 grams of anthraquinone of highest purity. The mixture is heated gradually to 135°C., while being stirred slowly, and held at this temperature for 3 hours. The mixture is then allowed to cool to 50°, and 80 grams of 66 per cent oleum is added during the course of 5 minutes, after which the whole is heated for 4 hours more at 110°. The

sulfonation mixture is then cooled and poured into 1.5 liters water, the aqueous suspension is heated to 80°, and the unchanged anthraquinone is filtered off and washed with hot water. The hot filtrate is treated with 150 grams of salt and cooled with stirring. After at least 10 hours, the sodium anthraquinone-2-sulfonate, which separates as plates, is filtered off, washed with a small amount of 10 per cent salt solution, pressed out, and dried. The yield is about 73 grams, and about 37 grams of anthraquinone is recovered.

Sodium anthraquinone-2-sulfonate, which is called "silver salt" in the industry because of its appearance, can be recrystallized from water to produce a material which is almost chemically pure. The air-dried material contains one molecule of water of crystallization.

(b) 2-Aminoanthraquinone

50 grams of sodium anthraquinone-2-sulfonate, 120 grams of 25 per cent ammonia, 25 grams of ammonium chloride, and 36 grams of sodium arsenate are placed in a rotating autoclave (page 359) which is heated slowly to 120°C. The temperature is then raised to 200° over a period of 1 hour and held at this point for 12 hours. The pressure increases to about 40 atmospheres. The autoclave is then cooled, and the residual pressure is released through the valve. The 2-aminoanthraquinone, which has separated, is filtered off, washed with water, boiled with about 200 cc. water containing 3 to 4 cc. 40° Bé sodium hydroxide solution, filtered off again, and washed with water. Further purification is effected by treating the crude product with several 200- to 300-cc. portions of boiling 5 per cent hydrochloric acid, cooling to 50–60°, filtering, and washing thoroughly with hot water. The product, after drying, weighs about 30 grams and melts at 300–301°. It is almost chemically pure, but can be improved by reprecipitation from concentrated sulfuric acid* or by crystallization from boiling chlorobenzene.⁷⁷ It has been shown that the completely pure 2-aminoanthraquinone gives an indanthrene blue which is purer and has better fastness to chlorine (see page 321).

Technical Observations. The solution of ammonium sulfite formed by the action of ammonia on anthraquinonesulfonic acid has a deleterious action on the end product. The sulfite must be removed, therefore, by oxidizing it to the sulfate.

* For example, 30 grams of the crude material is dissolved in 240 grams of concentrated sulfuric acid at a temperature not to exceed 35°, and 135 grams of 62.5 per cent (50° Bé) sulfuric acid is added. The nearly colorless crystals of the amine sulfate are filtered off on a sintered glass funnel, washed with 82–83 per cent sulfuric acid, and then converted to the free base by stirring with water.
⁷⁷ Kränzlein, Nawiasky, Corell, Kunz, and Schütz (Badische A. und S. F.), Ger. Pat. 421,206 [*Frdl.*, 14, 1495 (1921–1925)].

Previously, this was done with pyrolusite, but modern processes use arsenic acid (with 2-aminoanthraquinone) and sodium *m*-nitrobenzenesulfonate (with 1-aminoanthraquinone). The sulfite can also be removed by precipitation with alkaline earth chlorides, e.g., barium chloride. The procedure given above has the advantage that it yields a product which is practically ash-free. The ammonium chloride is added to neutralize the alkali formed in the reaction (the arsenite formed acts as free sodium hydroxide). The mother liquors, which contain arsenious acid, are poisonous, of course, and must be handled carefully. They are usually treated with milk of lime to render them harmless. The toxicity of such waste products is frequently overemphasized; if they are discharged into large streams, for example, they rarely poison the fish. In plant operations, the excess ammonia is collected and used over without further treatment.⁷⁸ For a general discussion of the sulfonation of anthraquinone, see page 56 ff.

24. 1-Aminoanthraquinone and 1,4-Diaminoanthraquinone

The preparation of 1-aminoanthraquinone is quite similar to that of the 2 isomer, except that the sulfonation is carried out in the presence of mercury salts which direct the sulfo group to the α position to the extent of 98 per cent.

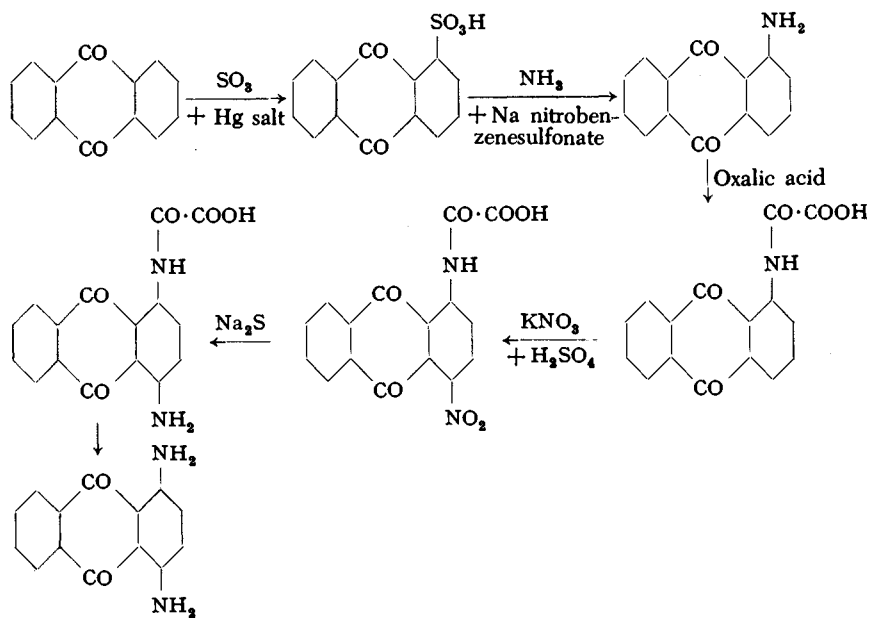

(a) Anthraquinone-1-sulfonic Acid

An intimate mixture of 208 grams of pure, dry anthraquinone and 4 grams of elutriated mercuric oxide or mercuric sulfate is added, with

⁷⁸ See also, Geigy, Ger. Pat. 347,683 (1921) [*Frdl.*, 13, 398 (1916-1921)].

stirring, to 200 cc. oleum containing 20 per cent SO_3 . The mixture is stirred at 50°C . until solution is complete, and then the temperature is raised to 130 – 135° in the course of 1 hour. During the next 2 hours, 50 grams of 60 per cent oleum (or the equivalent quantity of oleum of a different concentration) is added dropwise, and stirring is continued for 1 hour more at 135° . The mixture is then cooled and poured into 2 liters ice water. The diluted mixture is heated to boiling and filtered to remove unreacted anthraquinone (about 60 grams). The filtrate is heated to boiling and treated with a hot solution of 80 grams of potassium chloride in a small amount of water. The potassium salt of anthraquinone-1-sulfonic acid separates in beautiful crystals. The mixture is allowed to cool to 60° with stirring and held at this temperature for 6 hours. It is then filtered through a warm funnel, and the precipitate is washed with saturated KCl solution, then with a small volume of water, and dried. The yield is about 190 grams, or 58 per cent of the theoretical amount.

An additional 15 to 20 grams of less pure material is obtained by cooling the mother liquor. This fraction is mixed with some of the potassium salt of the 1,5-disulfonic acid which is very soluble at 60° , but rather difficultly soluble in the cold.

(b) 1-Aminoanthraquinone

A mixture of 60 grams of potassium anthraquinone-1-sulfonate, 120 grams of 24 per cent ammonia, and 21 grams of sodium *m*-nitrobenzenesulfonate is placed in a rotating autoclave. The temperature is raised to 170 – 175°C . over a period of 4 hours and held at this point for 12 hours. The pressure is about 24 to 27 atmospheres. After cooling, the contents of the autoclave are filtered, and the precipitate is pressed out strongly and washed with a small volume of hot water. The solid is then placed in 300 cc. boiling water to which some hydrochloric acid has been added, and the mixture is filtered hot, washing the residue thoroughly with hot water. The product thus obtained is a technically pure grade of 1-aminoanthraquinone melting at 238° . The yield is about 39 grams, or 95 per cent of the theoretical amount. Crystallization from xylene yields the amine in the form of small red black prisms with metallic reflex, melting at 241° . The yield of pure amine is about 75 per cent of the theoretical amount.

(c) 1-Anthraquinonyloxamic Acid⁷⁹

In an agitator kettle containing a few steel balls (similar to the one

⁷⁹ Noelting and Wortmann, *Ber.*, 39, 642 (1906). Curtis, *Dissertation*, Zürich-Weida, 1929.

described on page 87), a mixture of 44 grams of 1-aminoanthraquinone and 132 grams of anhydrous oxalic acid is heated in an oil bath to 115–120°C. (internal temperature), with stirring, until the originally red melt has become brownish yellow and resolidified. This requires about 1.5 hours. The reaction is completed when a test sample, extracted with water, shows the correct melting point of 224–226°. The mixture is treated with 350 cc. hot water, boiled for 30 minutes, filtered hot, and the residue is washed with hot water and dried. About 57 grams (98 per cent of the theoretical amount) of the oxamic acid, melting at 224–226°, is obtained.

(d) 4-Nitro-1-anthraquinonyloxamic Acid

The oxamic acid from (c) (57 grams) is dissolved in 570 grams of sulfuric acid (66° Bé), and the solution is cooled to 0°C. With good stirring, 21.7 grams of finely powdered potassium nitrate (dried at 120°) is added, maintaining a temperature of 0–2°. Stirring is continued for 6 hours at 0°, and the mixture is placed in an ice chest overnight. It is then poured onto 2 kilograms of ice, and the precipitate is filtered off, stirred with 2 liters water, filtered again, and washed thoroughly with cold water.

(e) 1,4-Diaminoanthraquinone

The moist filter cake from (d) is mixed with 600 cc. water, the mixture is heated to boiling, and enough soda is added carefully to make the mixture definitely alkaline. The brown flocculent precipitate changes to a resinous mass. 200 grams of crystalline sodium sulfide is added, and the mixture is boiled under reflux for 2 hours. In this treatment, the nitro group is reduced and the oxalic acid residue is split off. The mixture is filtered hot, and the precipitate is washed with hot water until the washings are nearly colorless. Contrary to the usual procedure, in this case the wash liquid is not sucked out completely each time and full suction is applied only after the final wash. The dried 1,4-diaminoanthraquinone weighs about 45 grams (about 95 per cent of the theoretical amount based on 1-aminoanthraquinone) and melts at 260–265°.

Technical Observations. Indanthrene red 5 GK is formed by benzoylation of 1,4-diaminoanthraquinone, and indanthrene yellow GK by benzoylation of the 1,5 isomer.

1-Aminoanthraquinone is used not only in the preparation of 1,4-diaminoanthraquinone; it is the starting material for a series of important anthraquinone dyes of which alizarin pure blue B is an example. The preparation of this dye is briefly as follows:

1-Aminoanthraquinone in 10 parts of glacial acetic acid is treated for 2 days at 50°C. with 2.5 moles of bromine. The reaction mixture is poured into bisulfite solution to destroy the excess bromine, yielding 1-amino-2,4-dibromoanthraquinone, m.p. 222° (from glacial acetic acid). One mole of this product is dissolved in 7 parts of dry *p*-toluidine, and the solution is heated to 200° with exactly 1 mole of anhydrous sodium acetate. Some of the *p*-toluidine is distilled off to carry out all of the water. When the reaction is completed, the mixture is diluted with an equal volume of alcohol, filtered, and the product is washed with alcohol. A yield of about 82 per cent of 1-amino-2-bromo-4-*p*-toluidinoanthraquinone is obtained. This base is dissolved in 6 parts of 100 per cent sulfuric acid at 25°, and about 1.5 parts of 66 per cent oleum is added carefully over a period of 1 hour. The temperature must not exceed 45° or the dye is destroyed. When a test portion is completely soluble in soda solution, the reaction mixture is poured into a large volume of water, and salt is added to make the solution 10 per cent with respect to salt. The precipitated dye is filtered off, washed with 10 per cent salt solution, and dried at 90°. The yield is quantitative.

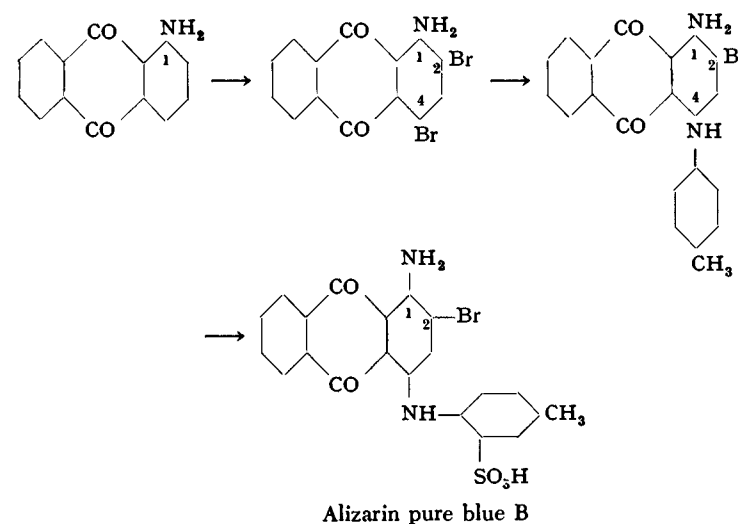

Alizarin pure blue dyes a pure blue quite similar to the color of aniline blue (triphenylrosaniline). Its color strength is high and its light fastness is very good. It is especially valuable for tin phosphate weighted silk with which it is widely used.

If an amine is used, instead of ammonia, to react with anthraquinone-1-sulfonic acid, the corresponding derivative of 1-aminoanthraquinone is formed. For example, methylamine yields methylaminoanthraquinone, which, like the non-methylated base, is an important starting material for valuable anthraquinone dyes.

The sulfo group in anthraquinone-1-sulfonic acid is replaceable, not only by amino and substituted amino groups, but still more easily by halogen. Thus, 1-chloroanthraquinone is formed in quantitative yield by treating the potassium sulfonate in boiling hydrochloric acid with sodium chlorate. The product is completely pure. The 2-sulfonic acid also undergoes this reaction, but much more slowly.

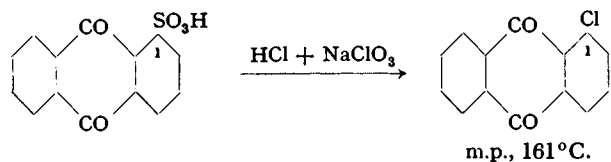

Reaction of the sulfonic acid with alcoholates or phenolates produces the ethers of erythrohydroxyanthraquinone (1-hydroxyanthraquinone):

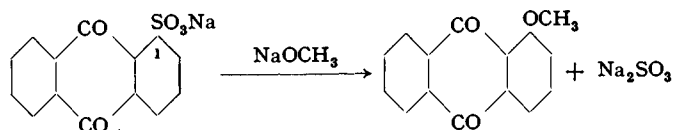

25. 1,5- and 1,8-Dihydroxyanthraquinone, and 1,5-Dichloroanthraquinone

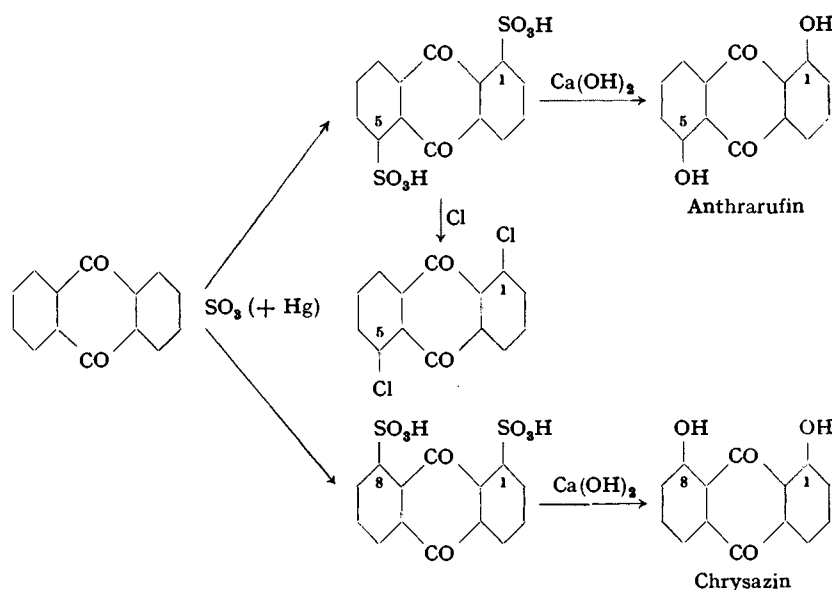

(a) Anthraquinone-1,5- and -1,8-disulfonic Acids⁸⁰

An intimate mixture of 200 grams of pure anthraquinone (dried at 140°C.) and 4 grams of elutriated mercuric oxide is added with stirring, over a period of 30 minutes, to 400 grams of 18 per cent oleum,

⁸⁰ Fierz-David and Krebsler, *Helv. Chim. Acta*, 10, 200 (1927).

the temperature being raised simultaneously to 75–80°. The mixture is heated to 120° and stirred at this temperature for 1 hour, after which 140 grams of 66 per cent oleum is added dropwise over a period of 3 to 4 hours. Care is taken that no unreacted anthraquinone remains on the walls of the reaction vessel or on the stirrer. Sulfonation is complete after stirring for an additional 10 to 12 hours at 120°, as shown by the formation of a clear solution when a test portion is diluted with water. The reaction mixture is allowed to cool to 50° and is then diluted by slow addition, with stirring, of 100 grams of concentrated sulfuric acid. After standing overnight, the anthraquinone-1,5-disulfonic acid has precipitated completely in a pure state. The solid is filtered off on a sintered glass funnel, washed with 50 cc. concentrated sulfuric acid, and sucked as dry as possible. The filter cake is then dissolved in 2 liters hot water, and the resulting solution is filtered hot and treated with 100 grams of potassium chloride in 300 cc. hot water to precipitate the difficultly soluble potassium sulfonate. The mixture is tested for complete precipitation by filtering a test portion and adding more KCl to the filtrate; no additional precipitate should be formed. The mixture is cooled, and the potassium salt is filtered off, washed with a total of 200 cc. cold water, and dried. The yield of potassium anthraquinone-1,5-disulfonate is 192 to 196 grams, or 45 to 46 per cent of the theoretical amount.

The concentrated sulfuric acid filtrate from the 1,5-disulfonic acid is diluted with an equal volume of water which must be added slowly and with good stirring in order to prevent local overheating and a splitting off of sulfo groups. The diluted solution is allowed to stand for 2 and 3 hours to precipitate most of the 1,8-disulfonic acid. This product is filtered off on a sintered glass funnel and washed with 44 per cent sulfuric acid. The free acid is converted to the potassium salt by dissolving it in 1.5 liters water and treating the hot solution with 80 grams of KCl in 200 cc. water. The yield of potassium anthraquinone-1,8-disulfonate is 98 to 100 grams, or about 23 per cent of the theoretical amount.

The mother liquor from the 1,8-disulfonic acid contains about 30 per cent of the original anthraquinone in the form of a complicated mixture of disulfonic acids (mainly the 1,7 acid along with a small amount of the 1,6 isomer, still smaller amounts of the 1,5 and 1,8 acids, and traces of the 2,6 and 2,7 compounds). This mixture cannot be separated in any simple way. In the industry, the residue is worked up to produce "silver salt" by prolonged heating of the diluted sulfuric acid solution at 180–200°. This treatment splits out sulfo groups in the 1 position, and the resulting mixture of anthraquinone and anthraquinone-2-sulfonic acid is treated in the manner described under the preparation of sodium anthraquinone-2-sulfonate (page 228).

The 1,5- and 1,8-disulfonic acids can also be isolated as their sodium salts which are somewhat more soluble than the potassium salts. The reaction mixture is neutralized with soda in this case.

Frequently, the 1,5- and 1,8-disulfonic acids are not isolated separately, but are taken out of the reaction mixture together. For this purpose, the sulfonation mixture is first diluted with concentrated sulfuric acid, then with sufficient water to make the solution 60 per cent with respect to sulfuric acid.

(b) 1,5- and 1,8-Dihydroxyanthraquinone

A mixture of 44.4 grams of dry, powdered potassium anthraquinone-1,5-disulfonate (or the 1,8 isomer, or a mixture of the two), 700 cc. water, 46 grams of hydrate of lime — $\text{Ca}(\text{OH})_2$ — and an aqueous solution of 5.5 grams of CaCl_2 , is heated in an autoclave with stirring for 20 hours at 195–200°C. The pressure is 14 to 16 atmospheres. After cooling, the contents of the autoclave are transferred to a beaker and heated to boiling. Concentrated hydrochloric acid is added carefully until the mixture shows a strongly acid reaction to Congo red, and boiling is continued until the odor of SO_2 disappears. The greenish yellow precipitate is filtered off and washed with hot water until the washings are neutral. The yield is 20 to 21 grams, or about 85 per cent of the theoretical amount.

1,5-Dihydroxyanthraquinone (anthrarufin) melts at 280°C., the 1,8 isomer (chrysazin) at 191°. When the mixture of the 1,5- and 1,8-disulfonic acids is used, the resulting mixture of the two dihydroxy compounds has an indefinite melting point of 235–255°.

Both of the dihydroxyanthraquinones are important starting materials for alizarin and indanthrene dyes. In many cases, the two isomeric dihydroxyanthraquinones give very similar dyes, and a mixture of the two can be used directly (e.g., see alizarin saphirol B and SE).

(c) 1,5-Dichloroanthraquinone

A mixture of 82 grams of potassium anthraquinone-1,5-disulfonate, 1 liter water, and 140 grams of concentrated hydrochloric acid is heated to 98–99°C., and a solution of 172 grams of potassium chlorate in 1500 cc. water is added, with stirring, over a period of 3 hours. The hot mixture is stirred until a filtered test portion gives, on cooling, no further precipitation of chloroanthraquinonesulfonic acid. This requires about 3 hours. The mixture is then filtered hot, and the product is washed with hot water until all of the acid is removed. The yield of dichloroanthraquinone, melting at 243–244°, is 45 grams, or about 88 per cent of the theoretical amount.

Both of the chlorine atoms are easily replaced by amino and phenoxy groups and the like, yielding technically important intermediates.

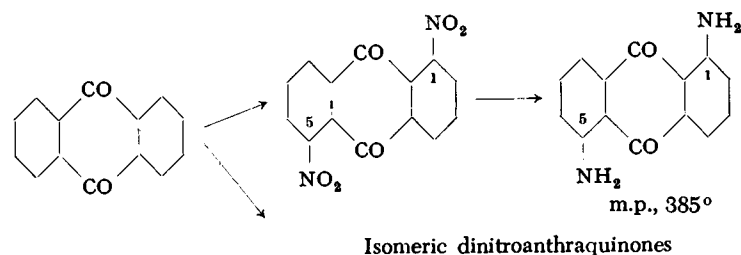
26. 1,5-Dinitroanthraquinone and 1,5-Diaminoanthraquinone**(a) 1,5-Dinitroanthraquinone**

To a solution of 100 grams of pure anthraquinone (m.p. 278–279°C) in 2000 grams of 100 per cent sulfuric acid is added, at 25° and with good stirring over a period of 30 minutes, 460 grams of mixed acid (230 grams of nitric acid (sp.g. 1.52) and 230 grams of 100 per cent sulfuric acid). The temperature rises to about 80° and 1,5-dinitroanthraquinone begins to separate during the addition of the nitric acid. The mixture is heated for 2 hours at 125° and then cooled. The pure yellow precipitate is filtered off on a sintered glass funnel and washed with 100 cc. 100 per cent sulfuric acid, then with water until the wash water is neutral. The dried product weighs 56 grams which is about 40 per cent of the theoretical amount. The acid mother liquor contains 1,8-, 1,6-, and 1,7-dinitroanthraquinones, which have no technical value.

(b) Reduction to 1,5-Diaminoanthraquinone

If the 1,5-dinitroanthraquinone is to be reduced, best results are obtained if the material from (a) is not dried. A suspension of the moist filter cake in 500 cc. water is heated to 80°C., and a concentrated solution of 350 grams of crystalline sodium sulfide is added. The mixture is stirred vigorously and heated to 100°. The 1,5-dinitroanthraquinone goes into solution forming a green color (alkali-soluble hydroxylamine derivatives), and after a short time red crystals of 1,5-diaminoanthraquinone separate. After 1 hour, the precipitate is filtered off and washed with water until the washings are colorless. The dried product, which is practically chemically pure 1,5-diaminoanthraquinone, weighs about 40 grams.

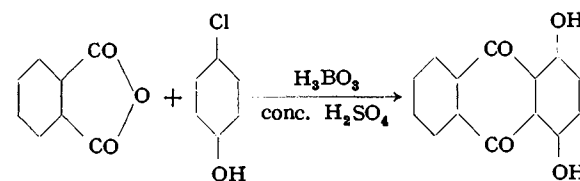
27. Quinizarin from *p*-Chlorophenol

Quinizarin is prepared industrially by condensation of phthalic anhydride and *p*-chlorophenol in the presence of concentrated sulfuric acid and boric acid at a temperature of 160–210°C. The boric acid ester of quinizarin which is formed can be separated by adding ice, and hydrolyzed to quinizarin by warming with water or soda solution. The

crude product must be purified by reprecipitation, recrystallization, or sublimation.

A mixture of 270 cc. concentrated sulfuric acid and 25 grams of boric acid in a 3-necked flask is heated to 50°C. in an oil bath until the boric acid is dissolved. While the temperature is kept at 50°, 96 grams of phthalic anhydride and 26 grams of *p*-chlorophenol are added alternately in portions, over a period of 1 hour, to the well-stirred acid mixture. The temperature is then raised slowly to 160° and held there for 3 hours. During the course of the next hour, the temperature is raised to 210° and held at this point for 4 hours more. It is essential that overheating be avoided.

The reaction mixture is now diluted to 60° Bé by slowly adding a mixture of 150 grams of concentrated sulfuric acid and 130 cc. water. It is then cooled thoroughly and poured onto ice. The precipitated boric acid ester is filtered off and mixed with 1 liter water. The suspension is boiled for 10 minutes with good stirring, filtered hot, and the precipitate is washed with 1 liter hot water. The mother liquor and wash water are collected separately, since the excess phthalic acid is crystallized from the former (about 40 per cent of the anhydride is recovered as phthalic acid).

The crude quinizarin is purified by stirring the filter cake into a paste with 50 cc. sodium hydroxide solution (50° Bé), adding hot water to make 1.5 liters, and heating to boiling by passing in steam. The solution is stirred vigorously and the quinizarin is precipitated as fine crystals by adding concentrated hydrochloric acid slowly. Further purification is effected by boiling the material with 1 liter water containing hydrochloric acid, filtering hot, drying the solid at 80–90°C., and finally crystallizing from chlorobenzene. The yield of purified quinizarin, melting at 194°, is about 35 grams, or 70 per cent of the theoretical amount.

Note. *p*-Chlorophenol, which has a strong unpleasant odor, can be replaced in laboratory preparations by an equivalent amount of hydroquinone.

II. Dyes

D. AZO DYES

The azo dyes constitute the largest and most varied group of synthetic organic dyes in use today. They will therefore be treated in considerable detail. The discussion will deal first with the general factors involved in the preparation of azo dyes, and a series of diazotization procedures will be given which have proven satisfactory, particularly for laboratory preparations. Following this, a number of examples will be given of technical procedures of diazotization and preparation of simple and complex azo dyes. The analytical methods are given in a separate section.

Laboratory Preparation of Azo Dyes

(a) Fundamental Considerations

The following points are of great importance: (1) The starting materials should be pure; (2) The quantities of materials should be measured accurately; (3) Vigorous and continuous stirring, or shaking, should be used, both in the diazotization and in the coupling; and (4) Diazo compounds should be protected from heat and light. They should be used immediately after being prepared.

(1) It is especially important that the starting materials should be free from isomers or closely related compounds (e.g., monosulfonic acid impurities in disulfonic acids, or *vice versa*) which can also enter into the dye-forming reaction. On the other hand, the slight brown or gray color, exhibited by many technical products, is usually unimportant. Extremely dark coloration or resinification indicates oxidation or decomposition of the material, and purification by distillation or crystallization may be necessary. The presence of sodium chloride or other alkali metal salts usually has no deleterious effect, but must be taken into account in calculating the quantities to be used.

(2) The amount of nitrite used in a diazotization must correspond *exactly* to the quantity required theoretically if the coupling reaction is carried out in acid solution, or if the coupling is done in alkaline solution and the mixture must be

acidified subsequently in isolating the dye. Any excess of nitrite under these conditions would diazotize or nitrosate the coupler, or, in the latter case, would alter the finished dye. When both the coupling reaction and the isolation of the dye are carried out in alkaline solution, a small excess of nitrite does no harm. The use of too little nitrite is bad because it leads to the formation of diazoamino compounds or to coupling of the diazotized base with itself.

It is customary to use a small excess (3 to 5 per cent) of an *end* component so that the coupling reaction goes rapidly to completion. *Middle* components in dis- and polyazo dyes, however, must be used in exactly the theoretical amount in order to prevent the formation of by-products.

In order to know the exact quantities of materials to use, it is essential to know their purity. Commercial products, which are isolated by distillation and which are taken from fresh stocks, are usually quite pure and can be considered 100 per cent materials. Examples of these are: aniline and its homologs, chloroaniline, anisidine, phenetidine, naphthylamine, phenol, cresol, resorcinol, naphthol, diphenylamine, etc. If the compounds have become dark colored or tarry on long standing, they should be purified before use by distillation, if necessary in vacuum. Undistillable materials, on the other hand, are rarely 100 per cent pure. This applies particularly to sulfonic acids and their salts which usually contain inorganic salts, and often water of crystallization. The purity of such materials must be determined if it is not given by the supplier. The determination, in the case of diazotizable amines, is done by titration with nitrite solution, and in the case of coupling components, with diazo compounds (see Analytical Section). The purity of such a material is expressed most simply in terms of its apparent molecular weight (*M*), i.e., as the number of grams of the technical product which contains 1 mole of the pure material. If, for example, 1 gram of technical H acid requires 26.8 cc. 0.1 *N* diazo solution, *M* is 10,000/26.8, or 373. Then, to prepare 0.1 mole of a dye, 37.3 grams of the technical H acid would be used.

Technical sodium nitrite is never quite 100 per cent pure, and should be titrated before use. When diazotizations are being carried out frequently, it is convenient to have nitrite available in three forms: (a) 1 *N* nitrite solution (1 mole of NaNO₂ in a liter); for preparation, see page 385; (b) 5 *N* nitrite solution (1 mole of NaNO₂ in 200 cc.); and (c) solid nitrite.—The technical product is dried in a steam heated oven, then powdered finely and stored in an air-tight container (since it takes up moisture). The NaNO₂ content is determined by titration.

(4) Decomposition of diazo compounds is accelerated by heat and frequently by light. This decomposition takes place more rapidly the more alkaline the solution, insofar as the alkali does not cause rearrangement to the isodiazotates. The latter compounds are quite stable and either do not couple at all or couple very slowly. Excess acid improves the stability of diazo compounds. The first sign of decomposition is generation of nitrogen. In all work with diazo compounds, decomposition is held in check by strong cooling, protection from bright light, and, insofar as possible, maintaining high acidity. In general, the more basic an amine, the more unstable is the diazo compound derived from it; conversely, negative (acidic) substituents, such as halogen, nitro, sulfo, etc., increase the stability of diazo compounds. The *o*-hydroxydiazo compounds have unique characteristics, due to their particular structure, and exhibit extraordinarily high stability, at least in the absence of alkali.

Many diazo compounds undergo still another type of decomposition reaction in addition to the usual conversion to the phenol with the liberation of nitrogen. This second decomposition reaction involves a replacement, by hydroxyl, of a substituent located ortho to the diazo group. The substituents which are subject to this replacement are halogen, alkoxyl, nitro, and sulfo groups. The reaction is favored by higher temperature and alkalinity, and by the presence of negative substituents (e.g., halogen, nitro, sulfo, carbonyl, etc.). It takes place especially easily in compounds

having two diazo groups located meta to each other. This reaction is actually used technically for the preparation of *o*-hydroxydiazo compounds. In cases where the replacement reaction is undesired, it must be minimized by working at low temperatures and in as strongly acidic medium as possible.

The work should always be organized so that the coupling reaction can be carried out immediately after the diazo compound is made, and in no case should the diazo compound be held for a prolonged period of time. If the diazo compound is isolated in the solid form, precautions must be taken to keep it moist since even relatively stable diazo compounds may explode violently when prepared in the dry state; *o*-hydroxydiazo compounds of the naphthalene series are exceptions.

(b) Diazotization

The diazotization reaction proceeds according to the equation:

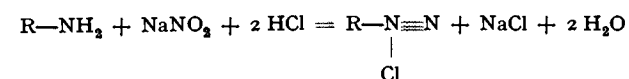

Hydrochloric acid is usually employed in diazotizations in aqueous solutions because it gives, in general, the most soluble salts with aromatic amines. If sulfuric acid is used, only 0.5 mole is used in place of 1 mole of hydrochloric acid.

If the molecule contains a free sulfonic acid group, only 1 mole of HCl is necessary:

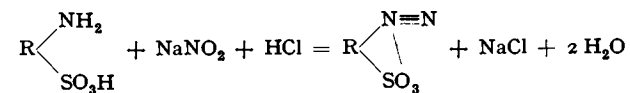

While the nitrite must be used in exactly the amount theoretically required, an excess of acid is always used. For laboratory preparations, as a rule, the excess acid used is about 0.5 equivalent over the theoretically required 2 equivalents. The excess of acid must be increased to 1 to 3 equivalents in diazotizations of weakly basic amines whose salts are readily hydrolyzed (e.g., chloro- and nitroanilines). In some cases where even this larger excess of acid is insufficient to dissolve the base (e.g., nitrochloroaniline), the diazotization may be carried out in suspension provided that the base is present in a finely divided state. Thus, a solution of the base in concentrated sulfuric acid may be poured into ice water, the base filtered off and washed and then made up into a paste. Even this method fails to work with some bases such as dinitroaniline and nitrodichloroaniline; these compounds can be diazotized smoothly only in concentrated sulfuric acid solution.

Aminosulfonic and carboxylic acids can be diazotized in the normal way if they are readily soluble in acid solution. Usually, however, this

is not the case, and it is recommended that diazotization be carried out by dissolving the alkali metal salt of the amino acid and the required amount of nitrite in water and adding the resulting neutral solution, with good stirring, to dilute hydrochloric acid (reversed diazotization). In this way, the free amino acid and the nitrous acid, formed simultaneously in the reaction mixture, react before the amino acid is precipitated. When, however, a free aminosulfonic acid is very insoluble, as is often the case with aminoazo dyes which are to be diazotized further in the preparation of polyazo dyes, the sulfonic acid may be precipitated before diazotization can occur. In these cases it is very difficult to obtain complete diazotization, especially if the diazo compound is also very insoluble. Under such circumstances, it is often advantageous to use a considerable excess of nitrite and add a small portion of it to the hydrochloric acid first. In addition, the solution of the amino acid is made very dilute and is added very slowly to the well stirred acid containing some nitrite. When the diazotization is completed, the diazo compound is filtered off to separate it from the excess nitrous acid.

None of the methods mentioned gives satisfactory diazotization of 1,2- and 2,1-aminonaphthols or their sulfonic acid and other derivatives, all of which are readily oxidized to quinones by nitrous acid in acid solution. Diazotization of these compounds can be carried out successfully by using just enough acid to make the aminonaphthol salt, or, in the case of the sulfo derivatives, to make the compound containing *one* free sulfo group, and treating with nitrite in the presence of one equivalent of a zinc salt or a small amount of a copper salt. If a copper salt is used, the copper must be removed when diazotization is complete, but the presence of zinc in a diazo solution usually does no harm.

Special techniques must be used in diazotizing bases which contain a secondary amino group in addition to the primary group, such as monoethyl-*p*-phenylenediamine and especially *p*-aminodiphenylamine. These compounds can easily be diazotized in such a way that the secondary amino group is unattacked; the resulting diazo compounds, however, couple very slowly and are unstable. A procedure is used, therefore, which involves the action of 2 moles of nitrite for each mole of base, diazotizing the primary amino group and simultaneously nitrosating the —NH^* group. The resulting nitrosated diazo compound has much better coupling properties and much higher stability. After coupling, the nitroso group must be split off from the dye molecule, usually by warming with acids or bases or by treatment with weak reducing agents such as bisulfite (variamine dyes).

* Secondary amine.

It should be noted that *concentrated* hydrochloric acid reacts with nitrite to give chlorine, which, of course, leads to side reactions. For this reason, the diazotization mixture should never contain more than 20 per cent of free HCl.

With diazotizations carried out in dilute solution, it is not necessary to add the nitrite solution slowly. On the contrary, it may be desirable to add the nitrite all at once, as in the case of bases which tend to form diazoamino compounds or to couple with themselves. It is only necessary to provide adequate cooling, and this is accomplished most easily by adding ice directly to the diazotization mixture.

Examples

1. Aniline. A solution of 9.3 grams (0.1 mole) of aniline (purified by redistillation if necessary) in 125 cc. 2 *N* hydrochloric acid is cooled in a beaker surrounded by ice and stirred with a turbine or electric motor. (The quantities given in all examples assume 100 per cent material; the quantities must be increased, of course, if the material is impure (see page 240.) When the solution is cold, a few pieces of ice are added, and 100 cc. 1 *N* nitrite solution is added dropwise from a dropping funnel. The addition of the nitrite need not be made slowly provided the temperature does not rise above 0°C. and each drop is immediately stirred into the reaction mixture. If necessary, more ice is added to the mixture. There should be no formation of gas bubbles and the solution should not become cloudy or colored. The mixture is stirred for about 10 minutes after completing the addition of nitrite and is then tested to make sure that it gives a strong blue coloration with Congo red paper and a weak blue test with either starch-iodide paper or "sulfone-reagent."* If the mixture does not give the weak test for nitrite, more nitrite solution is added dropwise until a positive test is obtained which persists for a few minutes. If, on the other hand, a strong test for nitrite is obtained, a few drops of a dilute solution of aniline hydrochloride is added until the nitrite test nearly disappears. If more than a few drops of nitrite or aniline hydrochloride solution is required for this final adjustment, a large error must have been made in weighing

* O. Stein, *Ber.*, 27, 2806 (1894). This reagent is 4,4'-diaminodiphenylmethane-2,2'-sulfone:

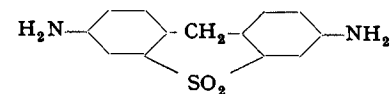

A few drops of a 10 per cent solution of the base in dilute hydrochloric acid is placed on a filter paper, and 1 drop of the solution under test is added. In the presence of nitrite, an unstable blue coloration is formed. The reagent is somewhat less sensitive than starch-iodide, but is usable even in strongly acid solutions.

or measuring, or the nitrite solution is incorrect. Under such circumstances, the experiment should be discarded and started over again. This applies also where the diazotization mixture becomes cloudy or strongly colored.

Instead of carrying out the reaction in a beaker with mechanical stirring, diazotization on a small scale can be done in an Erlenmeyer or round-bottomed flask using hand agitation. Under these conditions, external cooling is dispensed with and more ice is added to the reaction mixture (about 100 grams for the quantities of materials given above). The flask used must be sufficiently large to permit vigorous swirling without spilling. The flask is shaken continuously while the nitrite solution is added in a thin stream from a graduated cylinder. Any drops of nitrite adhering to the walls of the reaction flask are rinsed down with a wash bottle. The mixture is shaken for a few minutes more and then tested as described above.

When it is desired to make a concentrated diazo solution, 5 *N* nitrite solution, or even solid nitrite, is used instead of the 1 *N* solution. The solution must be especially well stirred if solid nitrite is added. Also, more concentrated acid can be used. Enough water must be present so that the hydrochloride of the amine is soluble at least in the warm solution, and an effort should be made to obtain as finely divided a precipitate as possible when the solution is cooled, e.g., by stirring or shaking during cooling. If this precaution is taken, the precipitated hydrochloride goes into solution easily when the nitrite is added. If the amine forms a very difficultly soluble hydrochloride, the base should be dissolved first in hot water containing only one equivalent of hydrochloric acid and the remainder of the acid (which has a salting out action) should be added later.

A similar procedure can be used in the diazotization of homologs and alkoxy derivatives of aniline, *m*-halogen derivatives of these, polynuclear bases such as benzidine, diaminodi- and -triphenylmethanes, diaminodiphenylether, etc., and their derivatives, and, in general, for all amines of the benzene series whose hydrochlorides are not decomposed by water. Aminosulfonic and carboxylic acids can also be diazotized by the above procedure if they are sufficiently soluble in dilute hydrochloric acid.

2. *p*-Chloroaniline. A solution is made by warming 12.75 grams (0.1 mole) of *p*-chloroaniline with 100 cc. water and 30 cc. concentrated hydrochloric acid. The solution is cooled with stirring or shaking, ice is added, and diazotization is carried out as in example 1.

o-Chloroaniline, *m*-nitroaniline, and other amines having similar basicity, can be diazotized similarly, varying the amount of water used to suit the solubility of the particular amine.

3. 2,5-Dichloroaniline. A mixture of 16.2 grams (0.1 mole) of 2,5-dichloroaniline, 50 cc. concentrated hydrochloric acid, and 200 cc. water is boiled in a 1-liter round-bottomed flask until solution is complete (except for possible impurities in the amine). The solution is cooled under a water tap with vigorous shaking to obtain a finely divided precipitate of the amine hydrochloride. 100 grams of ice is added and then

100 cc. 1 *N* nitrite solution is added slowly with continuous shaking. Shaking is continued until all of the precipitate has gone into solution, and the usual tests with Congo red and starch-iodide are made. The solution is filtered if necessary.

Other dihalogenated bases are diazotized in the same manner.

4. Aceto-*p*-phenylenediamine. The hydrochloride of this base is quite insoluble, and heating with acids must be avoided because of the danger of hydrolysis. An attempt is not made, therefore, to obtain complete solution of the base, but the diazotization is carried out with a suspension of the finely divided hydrochloride.

15 grams (0.1 mole) of monoaceto-*p*-phenylenediamine is ground to a fine powder in a mortar, and 50 cc. 2 *N* hydrochloric acid is added gradually along with pieces of ice to prevent the mixture from becoming too warm. The mixture is ground to a uniform paste, then transferred to a filter flask, rinsing out the mortar with cold water. The filter flask is placed in an ice bath and more ice is added directly to the mixture, and then are added, successively, 75 cc. 2 *N* hydrochloric acid and 100 cc. 1 *N* nitrite solution, the latter addition being made dropwise with constant stirring. Stirring is continued until all of the material has gone into solution. A few larger lumps, which may remain undissolved, are removed by filtration.

5. Aminoazobenzene. Aminoazobenzene and many other aminoazo compounds are only slightly soluble even in hot, dilute hydrochloric acid. Again, no attempt is made to dissolve the base completely, and a procedure similar to example 4 is used except that it is not necessary to cool the mixture while the base is being ground with hydrochloric acid.

6. α -Naphthylamine. A mixture of 14.3 grams (0.1 mole) of α -naphthylamine, 120 cc. water, and 10 cc. concentrated hydrochloric acid (preferably free from sulfuric acid) is placed in a 1-liter round-bottomed flask and heated until solution is complete. An additional 12 cc. concentrated hydrochloric acid is then added, and the solution is cooled to room temperature under the tap with vigorous stirring. The resulting thick paste is mixed with 200 grams of ice, and an amount of dry, powdered sodium nitrite, equivalent to 6.9 grams of pure NaNO_2 , is added *in one portion* with stirring. The flask is then immediately closed with a rubber stopper and shaken vigorously until a nearly clear solution is formed. Any remaining lumps of α -naphthylamine hydrochloride are broken up with a glass rod and shaking is resumed until solution is complete. The diazotization should be complete in 10 to 15 minutes, giving a diazo solution reacting strongly acid to Congo red and giving a weak

test with starch-iodide paper. The success of the reaction depends on quick addition of the nitrite and on obtaining rapid mixing. Under these conditions, the formation of aminoazonaphthalene is greatly reduced, but is not prevented entirely. The few dark colored flocks can be removed by filtration. The material filtered off should be in very small amount, and the filtrate should be light yellow in color and completely clear. Reappearance of cloudiness in the filtrate indicates that an insufficient amount of acid or of nitrite was used. If a considerable amount of a violet brown precipitate is formed in the diazotization, the experiment has failed and cannot be corrected.

The diazotization can be effected more easily and smoothly by using a larger amount of hydrochloric acid and also a small excess of nitrite, provided that these changes do not interfere in subsequent reactions of the diazo compound.

β -Naphthylamine is diazotized in the same manner.

7. *p*-Nitroaniline. A mixture of 13.8 grams (0.1 mole) of *p*-nitroaniline, 30 cc. water, and 30 cc. concentrated hydrochloric acid, is heated until solution is complete. The solution is cooled to room temperature with shaking under the tap, 80 grams of ice is added, and then an amount of dry, powdered sodium nitrite equivalent to 6.9 grams of pure NaNO_2 is added in *one portion* with constant shaking. Shaking is continued until most of the precipitated material has redissolved, and the mixture is allowed to stand for about 10 minutes in ice and is then tested with Congo red paper and sulfone reagent. Any residual undissolved material is removed by filtration. The residue should be very small; the filtrate should be clear and almost colorless and no cloudiness should reappear. The final diazo solution is relatively stable in the dark but is very sensitive to light.

8. *o*-Nitroaniline. A solution is made by heating 13.8 grams (0.1 mole) of *o*-nitroaniline with 50 cc. concentrated hydrochloric acid. The hot solution is cooled to 30°C. with stirring, resulting in a thick, almost colorless paste of the hydrochloride. The paste is diluted with 100 cc. water, 100 grams of ice is added, and 20 cc. 5 *N* nitrite is dropped in with vigorous stirring. Stirring is continued, and more ice is added if necessary, until most of the material is in solution and all but a trace of the nitrite has been used. After filtration, the diazo solution is clear and almost colorless, and remains clear on standing.

9. 3-Nitro-4-toluidine. A mixture of 15.2 grams (0.1 mole) of 3-nitro-4-toluidine and 50 cc. concentrated hydrochloric acid is ground in a mortar and then allowed to stand until the orange yellow base is completely converted to the colorless hydrochloride — as shown by the ab-

sence of yellow specks on further grinding. Ice (100 grams) is added, and then 20 cc. 5 *N* nitrite solution is added slowly while stirring with the pestle. Most of the precipitate dissolves and any remaining lumps are broken up by continued grinding. The solution is finally filtered to remove residual undissolved material, yielding an almost colorless filtrate.

Alternatively, the procedure of example 10 may be followed after the nitro-toluidine is in the paste form.

10. 2-Nitro-4-chloroaniline. To a well-stirred mixture of 172.5 grams of a 10 per cent paste of 2-nitro-4-chloroaniline, 30 cc. concentrated hydrochloric acid, and 100 grams of ice in a beaker, is added slowly 100 cc. 1 *N* nitrite solution. Stirring is continued and the mixture is kept cold until most all of the solid material has gone into solution and only traces of nitrite remain in the mixture. The diazo solution is then filtered to remove traces of undissolved material.

The isomeric nitrochloroanilines can also be diazotized in this way when they are available in paste form. If the bases are to be used in the dry state, the procedure of example 11 can be used. Alternatively, the base can be made into a paste by dissolving in about 10 parts of concentrated sulfuric acid, pouring the resulting solution, with stirring, onto ice, filtering off the precipitate, and washing it with cold water until it is free from sulfuric acid.

11. 2,4-Dinitroaniline. 80 grams of concentrated sulfuric acid in a small round-bottomed flask is cooled in ice, or better in a freezing mixture, and to it is added, slowly and with stirring, an amount of dry powdered sodium nitrite equivalent to 6.9 grams of pure NaNO_2 . The temperature of the mixture is kept below 10°C. and precautions are taken that each portion of nitrite is immediately mixed into the acid and that no water gets into the mixture. No red fumes should be formed, and the solution should not become colored. Stirring is continued for about 10 minutes after all of the nitrite has been added, and then the flask is transferred to a water bath. When the temperature of the mixture has reached that of the water bath, *very gradual* heating is started and continued until the temperature has reached 70°. The mixture is then stirred at this temperature until all of the nitrite has dissolved. During these operations, care must be taken that the mixture never becomes appreciably hotter than the surrounding water bath, and at no time should fumes be generated or the solution become colored. When a clear solution is finally obtained, it is cooled in water or ice to about 20° (bisulfate separates), and 18.3 grams (0.1 mole) of pulverized 2,4-dinitroaniline is added in small portions. The mixture is stirred at room temperature until a test sample, diluted with ice, gives only a faint test

for nitrite. The reaction mixture is then poured onto 240 grams of ice (*not more!*), and the resulting solution is filtered to remove small amounts of undissolved material. The diazo solution should be used without delay.

When working with small amounts of material, it is convenient to use more sulfuric acid than specified above if it does not interfere with subsequent operations. When the diazotization mixture is diluted, sufficient ice is used to make the diluted mixture 25 per cent with respect to sulfuric acid. The more dilute the acid, the more rapid is the reaction in which the nitro group is replaced by hydroxyl.

The procedure given can be used for diazotizing all primary amines whose basicity is so low that they do dissolve in aqueous acids, such as the tri- and tetrahalogenanilines, dihalogennitroanilines, dinitroaniline, aminoanthraquinone, etc. If necessary, the amount of sulfuric acid can be increased in order to obtain complete solution. The sulfates of diazoanthraquinones are very difficultly soluble in dilute sulfuric acid. Hence, they can be filtered off after pouring the concentrated sulfuric acid solution onto ice, and thus freed from most of the excess acid.

12. Sulfanilic Acid. A solution of 17.3 grams (0.1 mole) of sulfanilic acid in 50 cc. 2 *N* soda solution and 50 cc. water is mixed with 100 cc. 1 *N* nitrite solution, and the resulting solution is added slowly with stirring to a mixture of 125 cc. 2 *N* hydrochloric acid and 100 grams of ice. A large part of the difficultly soluble diazo compound separates. If purity is a more important consideration than good yield, the diazo compound can be filtered off and mixed with a small amount of water for the coupling reaction.

The method given above is suitable for all aminosulfonic and carboxylic acids which are difficultly soluble in dilute hydrochloric acid. If the amino acid is very insoluble, the addition of its solution to the acid should be made very slowly and with vigorous stirring. With some of the naphthylaminesulfonic acids which have a tendency to couple with themselves, it is desirable to add some of the nitrite to the hydrochloric acid before the amine is added. It is also advantageous to use an excess of nitrite in these cases, if it does not interfere in later steps or if it can be removed by filtering off the diazo compound.

13. 1-Amino-2-naphthol-4-sulfonic Acid.⁸¹ To a mixture of 24 grams (0.1 mole) of finely powdered 1-amino-2-naphthol-4-sulfonic acid in 100 cc. water and some ice, is added a concentrated aqueous solution of 2 grams of copper sulfate. The mixture is cooled in ice, and 20 cc. 5 *N* nitrite solution is added slowly with stirring. The amino-naphtholsulfonic acid goes into solution slowly to form a yellow colored solution from which a few coarse particles are removed by filtration.

⁸¹ Ceigy, Ger. Pat. 171,024 (1906) and 172,446 (1906) [*Frdl.*, 8, 640, 646 (1905-1907)].

The filtrate is treated with 30 cc. concentrated hydrochloric acid which precipitates the diazo compound almost completely. The diazo compound is filtered off and washed with dilute hydrochloric acid. It is very stable and can be dried, without danger, to remove retained hydrochloric acid.

All other sulfonic acid derivatives of 1,2- and 2,1-aminonaphthols, as well as the unsubstituted 1,2- and 2,1-aminonaphthols (the latter in the form of their hydrochlorides), can be diazotized in this way. It is necessary to modify the conditions used in isolating the various diazo compounds because of their differing solubility properties. In cases where the free acid is too soluble, it can frequently be isolated satisfactorily as the barium salt.

The separation of the diazo compound can usually be eliminated altogether if the diazotization is carried out in the presence of zinc sulfate⁸² instead of copper sulfate.

14. *p*-Aminodiphenylamine.⁸³ A mixture of 23.3 grams (0.1 mole) of *p*-aminodiphenylamine sulfate and 30 cc. concentrated hydrochloric acid is ground in a mortar and rinsed with cold water into a beaker. Ice is added and 40 cc. 5 *N* nitrite solution is run in with thorough stirring. The mixture is stirred and kept cold until all of the nitrite has been consumed. In the reaction, the primary amino group is diazotized and the secondary amino group is nitrosated. After coupling, the nitroso group must be split off from the dye, usually by treatment with a mild reducing agent such as sodium bisulfite.

(c) Coupling

1. Theoretical

The following types of compounds undergo coupling reactions with diazo compounds: (a) Phenols. (b) Enolizable keto compounds of an aliphatic character, having a "reactive methylene group" which may be part of an open chain or a ring system, either homocyclic or heterocyclic. This group of compounds may be represented by the formula:



in which X is a negative group, such as $-COR$, $-CO_2R$, $-CN$, $-SO_2R$, etc. The pyrazolones belong to this group. (c) Primary, secondary, or tertiary amines in which the amino group is attached directly to an aromatic ring. (d) Pyrrole, indole, and similar ring systems.

⁸² Kalle & Co., Ger. Pat. 175,593 (1906) and 176,618 (1906) [*Frdl.*, 8, 648, 651 (1905-1907); *C.A.*, 1, 1202, 1208 (1907)].

⁸³ Cf. Laska, Zitscher, Christ, and Petzold (I.C.), Ger. Pat. 508,585 (1930) [*Frdl.*, 17, 967 (1932); *C.A.*, 25, 599 (1931)].

Phenol derivatives, in which the hydroxyl group has been converted to an ether or an ester, are incapable of coupling under normal conditions. Similarly, acyl derivatives of amines (benzoyl, acetyl, etc.) are unreactive. The sulfonyl derivatives of primary amines, such as *p*-toluenesulfonanilide, are exceptions; these compounds are soluble in caustic alkali and behave as phenols toward diazo compounds.

Aromatic compounds which contain two amino groups, two hydroxyl groups, or one amino group and one hydroxyl group, located para or ortho to each other, are not suitable as coupling components. These compounds reduce diazo compounds, being oxidized to quinones in the process. (Smooth coupling may be achieved in many cases by the addition of thiosulfates or thiocyanates.⁸⁴)

Primary monoamines of the benzene series react with diazo compounds to give diazoamino compounds, along with, or instead of, the isomeric aminoazo compounds. The formation of diazoamino compounds is favored by low acidity of the coupling solution. Methyl or alkoxy groups in the ortho, or, more effectively, the meta position relative to the amino group favor the formation of aminoazo compounds; particularly good coupling is obtained with bases having such substituents in both an ortho and a meta position, for example:

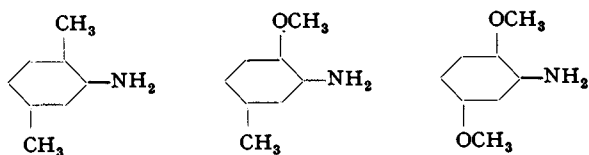

If it is desired to obtain aminoazo dyes from bases which tend to form diazoamino compounds, the amines can first be converted to their ω -sulfomethyl derivatives by reaction with formaldehyde and bisulfite:

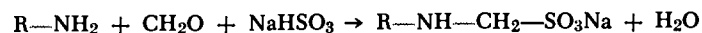

The sulfomethyl derivatives couple with diazo compounds to form azo compounds which yield aminoazo dyes on hydrolysis.⁸⁵

Coupling with phenols is usually effected more easily than coupling with amines, and naphthols couple considerably more readily than hydroxybenzene derivatives. Reactive methylene compounds behave similarly to phenols of the benzene series. Negative substituents (halogen, nitro, sulfo, carboxyl, carbonyl, etc.) accelerate coupling when

⁸⁴ See Geigy, Ger. Pat. 224,024 and 224,025 (1910) [*Frdl.*, 10, 844-845 (1910-1912)]; C.A., 4, 3304 (1910)].

⁸⁵ Cf. Agfa, Ger. Pat. 131,860 [*Frdl.*, 6, 872 (1900-1902)].

present in the diazo compound, and retard the reaction when present in the coupling component. Positive substituents have the opposite effect. A second hydroxyl or amino group, in the meta position in the coupler, or in the other ring in the case of naphthalene compounds, has a strong accelerating effect on the coupling reaction.

Coupling can be accelerated by warming the solution, increasing the alkalinity (lowering the acidity), increasing the concentration, or adding water-binding agents. The first two changes accelerate not only the coupling reaction but also the decomposition of the diazo compounds. It is necessary, therefore, to establish by trial whether any given slow coupling reaction is benefited by increasing the temperature or by raising the alkalinity. Generally, but not always, the best results are obtained in such cases in the cold at a point as nearly neutral as possible, but the coupling reaction requires a long time under these conditions. No disadvantages attend an increase in concentration of the coupling solution, and it is always desirable to conduct sluggish coupling reactions in as concentrated a solution as possible. If the diazo compound is difficultly soluble, as is the case with many sulfonic acids, it is frequently advantageous to filter it off and thus remove most of the diluting liquid. Much the same effect is produced by adding indifferent salts, especially common salt, or water-miscible organic solvents such as alcohol or pyridine. Obviously, these addition agents bind some of the water and thus effectively raise the concentration of the reactants. Pyridine also acts as an acid-fixing agent.

Diazo compounds always couple with amines and phenols of the benzene series to introduce the azo group para to the amino or hydroxyl group if this position is unoccupied. If the para position is occupied, the azo group enters the ortho position, but never the meta position. Phenols are capable of reacting with two or three molecules of the diazo compound, forming dis- and trisazo dyes, if both ortho and para positions are free. In some cases, substituents (e.g., $-\text{SO}_3\text{H}$ or $-\text{CO}_2\text{H}$) in the ortho or para position may be replaced by the azo group.

β -Naphthol and β -naphthylamine and their derivatives always couple in the adjacent α position. If this position is occupied, either the coupling reaction does not occur or the substituent is replaced by the azo group (e.g., with 2-naphthol-1-sulfonic acid). A sulfo group in the 8 position retards or prevents the introduction of an azo group in the 1 position.

α -Naphthol and α -naphthylamine and their derivatives usually couple in the 4 position, but the azo group may easily be introduced partially, or exclusively in exceptional cases with α -naphthol, into the 2 position.

α -Naphthol also tends to form disazo dyes by coupling in both the 2 and 4 positions. α -Naphthol and α -naphthylamine derivatives which are substituted in the 4 position couple exclusively in the 2 position; if both the 2 and 4 positions are occupied, coupling does not take place at all. A sulfo group in the 3 or 5 position interferes strongly with the introduction of an azo group into the 4 position, and therefore 3- or 5-sulfonic acid derivatives of α -naphthol or α -naphthylamine couple only in the 2 position with most diazo compounds. A mixture of the 2 and 4 azo compounds is formed, however, with diazo compounds which couple energetically (such as *o*- or *p*-nitro- or polyhalogen diazo compounds, or, to a smaller degree, diazotized derivatives of *p*-aminoazobenzenes, etc.).

With couplers containing both an aromatic amino group and a phenolic hydroxyl group, the amino group determines the position taken by the azo residue when coupling is carried out in acid solution, and the hydroxyl group is determinative in alkaline media. If coupling is carried out first in acid solution (directed by the amino group), a subsequent coupling reaction in alkaline solution can be used to introduce a second azo group (directed by the hydroxyl). The reverse order of coupling is not used successfully in any technical preparations.

2. Practical

The optimum conditions for coupling depend largely on the nature of the coupling component, but also on the nature of the diazo compound.

Phenols and Enolizable Keto Compounds. These compounds are coupled in alkaline (soda) solution as a rule. If the coupler is a sulfonic or carboxylic acid, or is soluble in water (e.g., resorcinol), it is dissolved directly in the required amount of soda solution. In other cases, the coupler is dissolved in the equivalent amount of dilute sodium hydroxide solution and the required amount of soda is added. Many couplers, such as naphthol AS, require an excess of caustic soda for complete solution; in such cases, no more is used than is absolutely required. (Solution of the 2-hydroxyl-3-naphthoic acid arylides is greatly assisted by the addition of alcohol. In many cases, no other method of dissolving the coupler is known.) An unnecessarily large excess of alkali is to be avoided, except in special cases, since such an excess rapidly decomposes the diazo compound. It is desirable to use that amount of soda which will be converted to bicarbonate by the acid of

the diazo solution (free acid plus that combined with the diazo group). In this way, no carbon dioxide is formed and foaming is avoided. The amount of soda is calculated on the basis of the following equations (taking into account, of course, any sodium hydroxide added):

Diazotization:

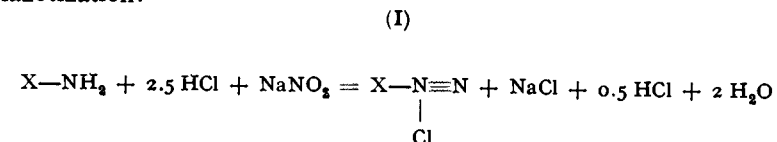

Coupling with a phenol dissolved in an equivalent quantity of sodium hydroxide:

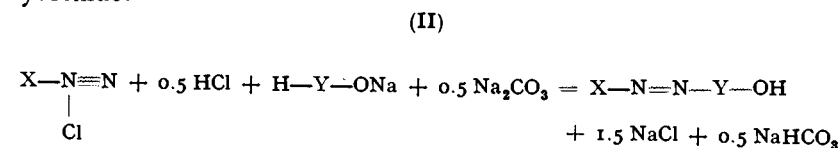

Coupling with a phenolsulfonic acid salt:

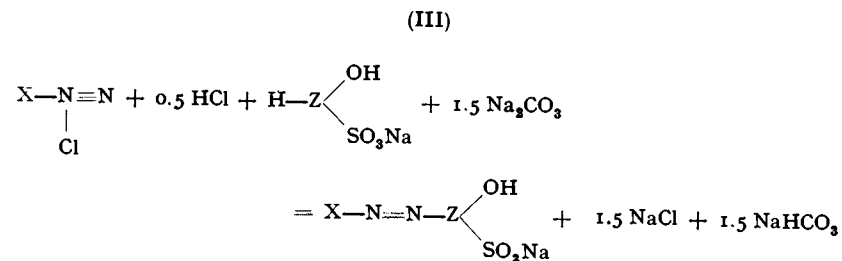

These equations show the minimum amount of soda necessary; an excess usually does no harm.

The acid diazo solution is added from a dropping funnel, slowly and *with good stirring*, to the alkaline coupler solution. The coupling reaction frequently takes place instantaneously and it is possible to work at room temperature. However, if the reaction requires a longer time, it is usually desirable to cool the reaction mixture in ice and to work in the absence of strong light. On the other hand, there are cases where coupling must be brought about by gentle warming. There are no general rules, and the optimum conditions must be established by test in each individual case if they are not disclosed in the patent literature.

To determine whether the coupling reaction is completed, a drop of the reaction mixture is placed on filter paper. The colorless ring surrounding the speck of dye is treated with a drop of a solution of a reactive coupler such as sodium β -naphtholate, R salt, or resorcinol, and then with a drop of soda solution or dilute sodium hydroxide. If unused diazo compound is present, dye is formed in the test spot. If the dye being made is easily soluble so that no colorless ring is formed, a small portion of the reaction mixture is treated in a test tube with salt to precipitate the dye, and a drop of this mixture is then used for the test. The presence of unused coupler can be determined in a similar manner, using a diazo solution to test the colorless ring.

Since *o*- and *p*-nitrodiazo compounds are rearranged, even by soda, to the noncoupling isodiazotates, it is desirable to work with these in the absence of soda and to use, instead, sodium acetate, or, in special cases, an acid-binding agent such as calcium carbonate or magnesia, so that the solution is never alkaline.

Similar procedures are used with diazo compounds in which ortho substituents are liable to be replaced by hydroxyl (page 240 ff.). In these cases, it is desirable to carry out the coupling reaction at as low a temperature as possible and to avoid the use of an excess of alkali in dissolving the coupler (perhaps adding a few drops of acetic acid to neutralize any slight excess). Reactions employing particularly sensitive diazo compounds, such as 2,4-dinitrodiazobenzene, for example, must be carried out in mineral acid solution, and, in addition, at low temperatures and as rapidly as possible. If the coupler to be used is soluble only in caustic alkali, it is first dissolved as usual and then precipitated in as finely divided a state as possible, before adding the diazo solution, by dilute hydrochloric or sulfuric acid. The addition of a dispersing agent may be beneficial.

Coupling reactions with diazo compounds which are very sensitive to alkali often are most successful when pyridine is used as an acid-fixing agent. This is especially true in the preparation of secondary polyazo dyes with 1-amino-2-naphthol ethers or their sulfonic acids as intermediates.⁸⁶

Amines. These compounds are coupled, as a rule, in weakly acid

⁸⁶ Schweitzer (I.G.) Ger. Pat. 450,998 and 453,133 (1927) [*Frdl.*, 15, 521-522 (1928)], Schweitzer (I.G.), Ger. Pat. 476,080 (1929), Schweitzer and Huismann, Ger. Pat. 478,045 (1929) [*Frdl.*, 16, 996-997 (1931); *C.A.*, 23, 4348 (1929)].

or neutral solution. Different procedures must be used, depending on the solubility of the amine used.

Amines which are soluble in water as well as in dilute mineral acids (e.g., *m*-phenylenediamines, many naphthylaminepolysulfonic acids, etc.) are dissolved in water. If the coupler is capable of multiple coupling, the diazo solution must be added slowly and with stirring to the coupler solution. It is simpler, in other cases, to add the coupler to the diazo solution. With actively coupling diazo compounds, the coupling reaction begins immediately and is completed in a short time. With more sluggish diazo compounds, the mineral acid is neutralized with sodium acetate. If the coupling is still too slow, the mixture is neutralized with soda and kept as nearly neutral as possible throughout the reaction. Ice cooling is recommended when the coupling reaction requires a long time.

Amines which are difficultly soluble or insoluble in water, but soluble in dilute mineral acid (most of the unsulfonated monoamines), are dissolved in dilute hydrochloric or sulfuric acid and mixed with the diazo solution as described above. If coupling proceeds slowly under these conditions, the mixture can be neutralized with sodium acetate or soda, but must be kept fairly acid to Congo red in order to keep the coupler in solution. Since acid is set free in the coupling reaction:

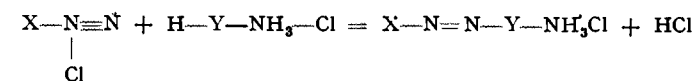

successive additions of acetate or soda must be made from time to time as the reaction proceeds. It is usually necessary to neutralize the mixture completely toward the end of the reaction in order to use the last portion of the diazo compound; this is done, if possible, only when the point is reached where so little coupler remains that it stays in solution despite its low solubility.

The addition of alcohol or some other water miscible solvent for the coupler is recommended when very sluggish coupling reactions are involved. It is then possible to have the solution neutral or acid (acetic) from the start. If the coupler tends to form a diazoamino compound (e.g., *m*-toluidine), the coupling reaction is always carried out in as strongly acid solution as possible.

Amines which do not dissolve in water or dilute acids (diphenylamine, phenylnaphthylamine, etc.) are most satisfactorily coupled, in the laboratory, in an organic solvent (alcohol, methyl alcohol, acetone, pyridine, etc.). In industrial preparations, such couplers are emulsified

with soap solution or other dispersing agents and very good results are obtained when the diazo compound is sulfonated and the resulting dye is therefore water soluble.

Sulfonated amines are dissolved as their alkali salts in water, and acetate solution, equivalent to the free mineral acid in the diazo solution plus that formed in the coupling reaction, is added. The diazo solution is added to the coupler solution with stirring. If necessary, the mixture is partially or completely neutralized with soda to accelerate the coupling.

With *aminophenols*, and especially *aminonaphtholsulfonic acids*, the position where coupling occurs depends on the reaction conditions. In acid solution, the amino group, and in alkaline solution, the hydroxyl group, exerts the determining orienting influence. Hence, in order to obtain a single dye, coupling is carried out either in distinctly alkaline solution or in strongly acid solution, depending on the desired result. If a primary disazo dye is desired, the first coupling reaction is always carried out in acid solution and the second in an alkaline medium.

For coupling in acid solution, the coupler is dissolved in water as its alkali salt, and hydrochloric acid is added until the mixture is just acid to Congo red. The resulting suspension is added to the diazo solution and the mixture is stirred in the cold until dye formation is completed. If the reaction is very slow, it can be accelerated by neutralizing the excess mineral acid with sodium acetate. The reaction mixture must always be kept weakly acid to Congo red, however.

Alkaline coupling is carried out, as in the case of phenols, with the addition of soda. If the diazo compound is sensitive to alkali, it is desirable to add only a small portion of the soda at the start to dissolve the coupler and the remainder simultaneously with the diazo solution. In this way, the solution is kept only weakly alkaline throughout the course of the reaction. The addition of the diazo solution should be made slowly and with vigorous stirring.

Benzidine Dyes. In the preparation of mixed disazo dyes from benzidine and similar bases, the first coupling reaction must be carried out under conditions which will prevent the formation of the symmetrical disazo dye. Hence, the first coupling reaction is done with the coupler which reacts less readily, and the more active coupler is used in the second coupling step. If there is not a large difference between the two couplers with respect to coupling reactivity, the first coupling reaction is carried out under the mildest conditions possible (low alkalinity or

strong acidity). Furthermore, contrary to the usual practice, the solution of the first coupler is added with good stirring to the tetrazo solution since the reverse addition could lead to a temporary excess of the coupler in the reaction mixture. This procedure involves no difficulties because solutions of the tetrazo compounds of benzidine and its derivatives can be made alkaline with soda at low temperatures without causing decomposition. The second coupling reaction is started only after the first one is fully completed and all of the tetrazo compound has reacted. The second coupling is then carried out by the usual methods for monoazo dyes.

(d) Isolation of Dyes

1. Dyes without Sulfo or Carboxyl Groups

(a) *Aminoazo Dyes.* Dyes of this group which contain several amino groups, such as combinations with *m*-phenylenediamine, have, in general, pronounced basic characteristics (chrysoidine, Bismarck brown). They form water-stable salts with mineral acids and are generally used in this form. Such salts can be isolated by acidifying the coupling reaction mixture with the acid concerned (e.g., hydrochloric acid) and salting out the dye with a salt of this acid (e.g., sodium chloride). Alternatively, the dye base can be precipitated with alkali, filtered off, and redissolved in the desired acid. The salt is then recovered by crystallization.

Aminoazo dyes with only one amino group (aminoazobenzene type) are weak bases giving, in general, difficultly soluble salts which are readily hydrolyzed. If the dye is to be isolated as one of its salts, for example, the hydrochloride, the salt is precipitated from the reaction mixture by means of a considerable excess of hydrochloric acid. The precipitate is filtered off and washed with dilute hydrochloric acid, not with water. On the other hand, if the dye is to be used in coloring oils, fats, etc., it must be isolated as the free base and must contain no salts. For this purpose, the coupling reaction mixture is made alkaline and the precipitated dye is filtered off and washed thoroughly with water. The dye can be purified further by recrystallization from an organic solvent.

(b) *Hydroxyazo Dyes.* In this group, the dyes usually concerned are, with few exceptions, the *o*-hydroxyazo dyes which are insoluble in water and soda solution and which, therefore, are precipitated as they

are formed. These dyes are used as colors for spirit varnishes, oils, and fats, and also as pigments in the preparation of opaque colors. For the former applications, the physical form of the dye is immaterial and the precipitated dye can simply be filtered off, washed thoroughly with water, and dried. If necessary, the dye can be purified by recrystallization from an organic solvent. Pigment colors, on the other hand, are only filtered off, washed, and then made up in the form of a paste. Subsequent purification or other treatment is excluded. Steps must be taken, therefore, to ensure that the dye separates from the coupling reaction mixture in a pure condition and in a finely divided state. The latter is achieved, in cases where it is necessary, by adding Turkey red oil to the coupler solution before coupling.

2. *Dyes with Sulfo or Carboxyl Groups*

These dyes are usually isolated as their water soluble, alkali metal salts by a salting out process. The isolation must be carried out in such a way that the dye is precipitated as completely as possible while accompanying materials remain in solution. Also, the finished dye should not contain an unnecessarily large amount of inorganic salts. In some cases, the salts formed in the dye forming reaction suffice to effect the precipitation, but usually additional salt is required. A salt solution is used whenever possible in order to be certain that the precipitate does not include undissolved salt, and also to avoid contamination of the product by the small amount of insoluble material which is always present in salt. Solid salt is added only in the case of dyes which are so soluble that the solution must be saturated with salt to bring about precipitation. In certain instances, potassium chloride or ammonium sulfate gives more complete precipitation than sodium chloride. If the neutral alkali metal salt of the dye is appreciably soluble even in saturated salt solution, it is frequently possible to isolate the dye as the free acid or as an acid salt by adding acid, perhaps in combination with salt. In the event that such a dye acid is too insoluble for use in dyeing, it can be converted subsequently to the alkali metal salt by dissolving it in the required amount of alkali in a minimum quantity of water and evaporating the solution to dryness. Alternatively, the dye acid, after being dried, can be mixed with the required quantity of dry soda; the dry mixture can easily be dissolved by stirring in water.

The greatest difficulty is often encountered in getting the dye precipitated in a form which is easy to filter and wash. Usually, but not

always, it is advantageous to carry out the precipitation at about 70 to 80°C., less often at the boiling point, and to stir the mixture for a time at this temperature. This treatment often converts an originally slimy precipitate into a crystalline or granular form. In other cases, however, the reverse situation prevails, and a dye which is precipitated well in the cold becomes slimy on heating, so no general rules can be laid down. Test tube experiments must be carried out to establish the optimum conditions for each individual dye. The alkalinity of the solution is sometimes an important factor in determining the character of the precipitate, along with the temperature and salt concentration. It may be, for example, that an easily filterable precipitate can be obtained only from a solution which is exactly neutral.

If the dye has been precipitated from a hot solution, it is usually desirable to filter and wash at higher temperatures also; filtration is more rapid under these conditions, and the impurities are held in solution more completely. It is necessary to cool before filtration only if precipitation is incomplete in the hot solution. Washing is done with a salt solution corresponding in salt concentration and temperature to the mixture filtered. More complete removal of by-product dyes may be achieved if some soda solution is added to the wash liquid. If the product is still insufficiently freed from by-products, it must be purified by reprecipitation. For this purpose, the dye is dissolved in hot water, the solution is filtered if necessary and then salted out using about the same temperature and salt concentration as in the first precipitation.

The washed product is pressed out strongly to remove adhering salt solution as completely as possible, and then dried and powdered. Difficultly soluble dyes are preferably prepared finally in paste form and the dry weight determined with a test sample. Drying of dyes containing several nitro groups should be done with care at moderate temperatures, if they are dried at all, because of the danger of explosions.

Technical Diazotization Procedures

Aniline

(*Toluidine, Xylidine, m-Nitroaniline*)

A mixture of 9.3 grams (0.1 mole) of aniline in 30 cc. hot water is stirred with a glass rod while 25 cc. concentrated hydrochloric acid is added in a thin stream. The solution is allowed to cool to about 40°C.,

and enough ice is added to lower the temperature to 0°, leaving a little ice still unmelted. A 20 per cent solution* of sodium nitrite containing 7 grams of pure NaNO₂ is then added rapidly with good stirring. This nitrite solution, standardized with pure sulfanilic acid (see Analytical Section), should be kept in stock. The diazotization is complete when a drop of the reaction mixture gives an immediate test with both starch-iodide and Congo red. All diazotizations should be followed with these two reagents. The diazotization requires about 2 minutes (30 minutes in large scale operations), the final temperature is about 70°, and the total volume is about 250 cc.

When *p*-toluidine and the chloroanilines are used, some precipitation of the hydrochlorides occurs when the mixtures are cooled in ice. The precipitates disappear rapidly during diazotization.

p-Nitroaniline

Since *p*-nitroaniline does not form water stable salts, the base must be obtained in a highly divided state before the diazotization reaction. A clear solution of 13.8 grams (0.1 mole) of technical *p*-nitroaniline in 30 cc. concentrated hydrochloric acid and 30 cc. water at 80–90°C. is added with good stirring to a mixture of 50 cc. water and 50 grams of finely crushed ice. The temperature of the final mixture is about 8°. A 20 per cent solution containing 7 grams of sodium nitrite is then added *in one portion* with vigorous stirring. The temperature rises to 15° and the solution becomes clear in a few seconds. The usual tests with Congo red and starch-iodide are made. In large scale diazotizations, the nitrite solution should be added very rapidly below the surface of the liquid in order to prevent the formation of large amounts of the diazoamino compound.

α -Naphthylamine

α -Naphthylamine (14.3 grams, 0.1 mole) is dissolved in 22 grams of 30 per cent hydrochloric acid and 100 cc. hot water, and the solution is cooled to 0°C. by the addition of 200 grams of ice. 60 grams of salt is then added, and when the temperature has dropped to about –5°, 20 grams of 20 per cent sulfuric acid is added, followed by rapid addition of 7 grams of sodium nitrite in the form of a 20 per cent solution. Diazotization is completed in a few minutes, the difficultly soluble sul-

* Volume per cent: 1 liter contains 200 grams of 100 per cent sodium nitrite.

fate of naphthylamine going into solution in the process. The final volume is about 800 cc. and the temperature is below 0°.

Sulfanilic Acid

(*Metanilic Acid, Naphthionic Acid, Nitroanilinesulfonic Acid, Chloroanilinesulfonic Acid, Diaminostilbenedisulfonic Acid, Primulinesulfonic Acid, etc.*)

A solution of sulfanilic acid, equivalent to 17.3 grams (0.1 mole) of 100 per cent material, in 100 cc. water containing 5.5 grams of soda (if the sulfonate is used instead of the free sulfonic acid, the soda is omitted, of course) is treated with 25 cc. concentrated hydrochloric acid and then, with good stirring, with 35 cc. 20 per cent sodium nitrite solution. The diazotization requires about 10 minutes, during which the temperature should not exceed 15°.

Diazo compounds which contain a sulfo group are usually quite insoluble and precipitate as white or yellow crystals of the inner salt. Since many of the aminosulfonic acids themselves are also relatively insoluble, it is desirable to diazotize them by the indirect method. This is done by adding the necessary amount of nitrite to the solution of the sodium sulfonate, and pouring the solution into the acid.

Further difficulties are sometimes encountered because certain amines tend to couple with themselves. Cleve acids are examples. An excess of about 5 per cent of sodium nitrite is required in diazotizing them.

Benzidine

(*o*-Tolidine, *o*-Dianisidine)

A solution is made by heating to 70°C. a mixture of 18.4 grams (0.1 mole) of technically pure benzidine, 23 cc. 30 per cent hydrochloric acid, and 150 cc. water. (If a perfectly clear solution is desired, hydrochloric acid which is free from sulfuric acid must be used.) The solution is cooled to 30–40°, and 50 grams of ice is added, causing part of the hydrochloride to separate. An additional 23 cc. hydrochloric acid, diluted with water, is added with good stirring, and then 70 cc. of a 20 per cent nitrite solution is added over a period of 10 seconds. The temperature is about 10–12° and the solution should become clear in 1 minute. At lower temperatures, the last traces of benzidine sulfate disappear only after 8 to 10 minutes. The solution is tested with Congo red and starch-iodide paper. The solution is almost neutral, but no diazoamino compounds are formed as in the case of aniline.

Tolidine and dianisidine must not be boiled, but should be dissolved below 40°C. In the plant, the solutions are allowed to stand overnight with half of the hydrochloric acid, and the rest of the acid and the ice are added on the next day.

Coupling Reactions

Single Coupling Reactions with Hydroxy Compounds

Acid Orange A or Orange II

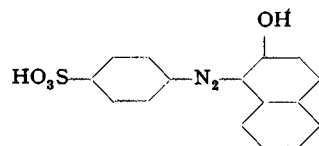

A solution of sulfanilic acid, equivalent to 17.3 grams (0.1 mole) of 100 per cent material, in 200 cc. water containing 6 grams of soda ash is boiled to drive off any aniline which may be present. The solution is filtered, treated with 30 cc. concentrated hydrochloric acid, and cooled to 20°C. The temperature is lowered to 10° by adding ice, and diazotization is carried out below 15° by adding 7 grams of 100 per cent sodium nitrite. The diazotization solution should give permanent tests with Congo red and starch-iodide papers.

While the diazotization reaction is being carried out, 14.4 grams (0.1 mole) of β -naphthol is dissolved in 200 cc. water containing 15 grams of 30 per cent sodium hydroxide and 25 grams of soda ash; a clear solution should be obtained. This naphthol solution is cooled in an ice bath to 3°C., and the suspension of diazosulfanilic acid is added in a thin stream. The temperature of the mixture should not rise above 8°. After 1 hour, the reaction mixture is transferred to a porcelain dish and heated to boiling over a free flame. The hot solution is treated with 100 grams of salt added portionwise. The precipitate which has now separated completely can easily be filtered at 50° on a large suction funnel. The product is then pressed out in a screw press and dried at 100°. The yield, which is about 50 grams, can be determined accurately only by a comparison dyeing test.

Technical Observations. Acid orange A is one of the most widely used monoazo dyes because of its low cost and bright color. In large scale preparations, the coupling reaction is done in huge pitchpine vats having a capacity of 15,000 liters or more, or in concrete vats measuring up to 40 meters across and lined with refractory tile.

(Fig. 56, page 376, shows the general arrangement of a plant with diazotization and coupling vats in addition to the pressure equipment and filter press.) The filtered dye is not pressed out hydraulically, but is held under air pressure in the filter press for 1 to 3 hours and then dried on copper sheets. Drying is usually done in vacuum drying ovens which give rapid drying under mild conditions. A cost analysis for this dye is described in detail later (page 378 ff.).

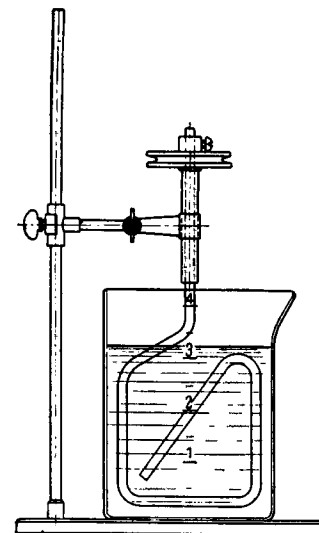
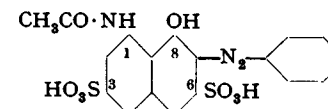

Fig. 32. Graduated vessel for coupling reactions.

In the case of this particular dye, the coupling reaction is usually carried out in a somewhat different manner whereby the soda is eliminated. The β -naphthol is dissolved in the required amount of caustic soda and the solution is mixed with an almost neutral suspension of diazosulfanilic acid. The β -naphthol is precipitated as fine crystals, and, as soon as the whole is thoroughly mixed, the amount of sodium hydroxide required to form the neutral sodium salt of the dye is added at 0°. Coupling takes place simultaneously, and the dye is filtered off cold without previously warming the mixture. The dye obtained is very concentrated and melts on the drying trays. This simple method was not given in detail here because most dyes cannot be made in this way. The procedure given, on the other hand, is applicable to almost all coupling reactions of β -naphthol (rocelline, brilliant orange, etc.).

Acetyl-H Acid and Amidonaphthol Red G



An amount of H acid equivalent to 35 grams of 100 per cent material (0.1 mole) is dissolved at 50°C. in 200 cc. water containing 6 grams

of soda ash. With vigorous stirring, 17 grams of acetic anhydride is added over a period of 15 minutes. Complete acetylation of the amino group in H acid occurs, but simultaneously the hydroxyl group is partly acetylated. To test for completion of acetylation, a small test portion of the solution is acidified with hydrochloric acid, treated with a few drops of sodium nitrite, and then made alkaline with soda. If much H acid remains in the mixture, a blue coloration is formed (coupling of diazotized H acid with itself). As the acetylation proceeds, the color formed in the test becomes weaker and more reddish (coupling of diazotized H acid with acetyl-H acid). When the reaction mixture contains no more unchanged H acid, only a yellow coloration, formed by nitrosation, is obtained in the test. (The test can be carried out advantageously on filter paper.) When acetylation is complete, 25 grams of soda ash is added, and the mixture is heated and stirred at 90–95° for 1 hour, replacing the water lost by evaporation. This treatment hydrolyzes the acetyl group on the oxygen but does not attack the acetyl-amino group. (If the treatment with soda is omitted, about 30 per cent of the starting material is lost, and the final dye is contaminated with decomposition products of the diazo compound.) The reaction can be controlled by titration with diazobenzene solution. The resulting soda solution is used directly in the coupling reaction. Acetyl-H acid combines with various diazo compounds to form beautiful azo dyes which are very fast to light and which level excellently. The important dye, amidonaphthol red G, for example, is formed with diazotized aniline.

Aniline (9.3 grams, 0.1 mole) is diazotized as described on page 259, and the diazo solution is mixed with the ice-cold soda solution of acetyl-H acid. The dye is salted out in the cold after 12 hours (20 per cent salt, calculated on the volume of the reaction mixture), filtered off, pressed in a screw press, and dried at 50°. The yield is about 50 grams.

If aminoacetanilide (page 132) is used in place of aniline, the excellent bluish tinted dye, amidonaphthol red 6B, is formed. This dye is more stable to light than the G brand.

Technical Observations. The dyes described above have largely replaced the analogous dyes from chromotropic acid (1,8-dihydroxynaphthalene-3,6-disulfonic acid). They are cheaper and more stable to light.

It is interesting to note that the acetylation cannot be carried out in wooden containers in the plant. Especially when pitchpine is used, the final dyes almost always come out dull in color. The acetylation is done, therefore, in enameled vessels. The industrial process also uses somewhat less acetic anhydride. The final dyes are pressed out hydraulically and dried in vacuum drying ovens at 60°C. Hydrolysis of the dyes is minimized, not only by using the lower temperature, but also by drying as rapidly as possible.

Fast Light Yellow G (Bayer)

This is the simplest member of the pyrazolone dyes which are prepared in two ways: (a) from dihydroxytartaric acid and phenylhydrazine (tartrazines), and (b) from phenylmethylpyrazolones by coupling with diazo compounds. The second method is simpler and has largely displaced the older, first method. The pyrazolone is prepared from a given phenylhydrazine (e.g., phenylhydrazinesulfonic acid, page 128) and acetoacetic ester, and coupled with diazotized aniline:

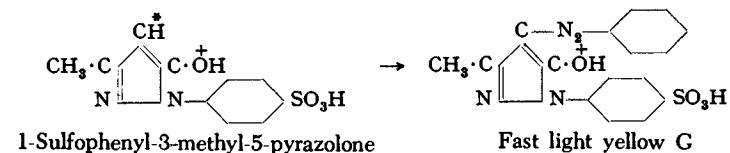

In the formula for the sulfophenylmethylpyrazolone, the starred hydrogen is the one which is replaced by the azo group. This hydrogen is adjacent to a hydroxyl group (+) which makes the coupling reaction possible. The hydroxyl group here is quite similar to those in phenols and naphthols, and can contribute to lake formation in azo dyes derived from *o*-aminophenols or *o*-aminonaphthols. These dyes are of the type:

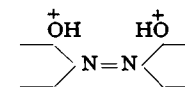

For example, a very stable chrome wool dye, eriochrome red B (Geigy) is formed from 1-amino-2-naphthol-4-sulfonic acid (page 201) and phenylmethylpyrazolone.

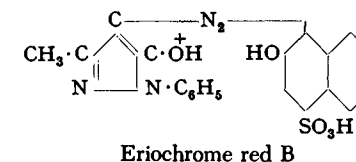

Sulfophenylmethylpyrazolone, equivalent to 26 grams (0.1 mole) of 100 per cent material, is dissolved in 120 cc. water containing 6 grams of soda ash, and 30 grams of sodium acetate is added to the solution. The solution is cooled to 0°C. and mixed with a phenyldiazonium solution prepared from 9.3 grams of aniline. The mixture is stirred until a

test portion, after being salted out, no longer gives a red color with alkaline resorcinol solution. The coupling reaction takes about 4 to 6 hours. The mixture is then heated to boiling and salted out with 100 grams of salt. The yield is about 40 grams of strong dye.

These pyrazolone dyes, especially the more complicated ones, are much more stable than fast yellow (page 271). The dyes derived from *o*-sulfoamines, such as *p*-toluidine-*m*-sulfonic acid or *p*-chloroaniline-*o*-sulfonic acid, are among the most stable yellow dyes known. Fastness to light can be increased still more, however, by using chlorinated phenylpyrazolones, instead of the sulfophenyl compound, in preparing the dye. The xylene yellow dyes (Sandoz) are chloro derivatives of this type and are used rather widely, despite their relatively high cost, because of their unparalleled fastness to light. The possible structural variations are almost unlimited, and only one example will be given: Polar yellow 5G (Geigy). This dye has the following structure:

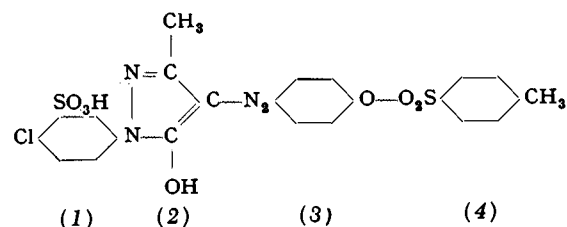

being made up of (1) *m*-sulfo-*p*-chloroaniline, (2) acetoacetic ester, (3) *p*-aminophenol, and (4) *p*-toluenesulfonic acid.

Polar yellow 5G is prepared by condensing *p*-chloro-*m*-sulfophenylhydrazine with acetoacetic ester, and coupling the resulting pyrazolone with diazotized *p*-aminophenol in acetic acid solution. The alkali-sensitive dye which is formed is treated at 70°C. with *p*-toluenesulfonyl chloride, in the presence of soda and 1 mole of sodium hydroxide, to esterify the hydroxyl group. This esterification makes the dye insensitive to alkali and, at the same time, fast to milling on wool.

Technical Observations. The manufacture of pyrazolone dyes is relatively simple. The arylhydrazine condensations are usually run in enameled vessels to minimize losses of expensive materials. Nothing particularly new is involved in the diazotization and coupling reactions.

Hansa Yellow G

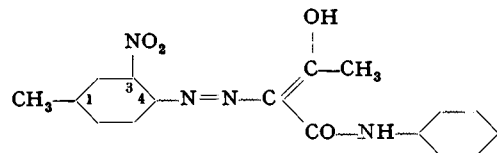

3-Nitro-4-toluidine (15.2 grams) is diazotized by the procedure given on page 246. Ice is added to the filtered diazo solution to lower the temperature to 2–5°C. The solution is then neutralized with sodium acetate to the point where Congo red paper is just turned violet.

Another solution is made by dissolving 17.7 grams of pure acetoacetanilide in 300 cc. water (at 50°) containing the minimum amount of caustic soda necessary to form a clear solution. About 12 cc. 35 per cent caustic is required. This solution is cooled, and 25 grams of crystalline sodium acetate is added. Dilute acetic acid is then added carefully until a faintly acid reaction to litmus is produced but no precipitation occurs. The clear diazo solution is now added dropwise with very good stirring, and stirring is continued for 12 hours. The dye, which is then completely precipitated, is filtered off and washed thoroughly, the final time with hot distilled water. The product is ground in a mortar to a uniform paste, preferably with the substrate if an opaque color is being prepared. A weighed portion of the material is dried to determine the yield. The yield is almost quantitative.

Technical Observations. Hansa yellow G is a pure yellow. More greenish brands are obtained by using *o*-nitroaniline or *o*-nitro-*p*-chloroaniline in place of nitrotoluidine, and also by substituting acetoacet-*o*- or *p*-chloroanilide for the acetoacetanilide. All of these dyes are extraordinarily fast to light, and they fulfill all the requirements of the pigment industry with respect to oil and spirit stability. They are among the most important pigment colors.⁸⁷

Permanent Red 2G⁸⁸

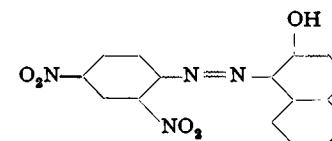

The procedure given on page 247 is used to diazotize 18.3 grams (0.1 mole) of pure 2,4-dinitroaniline, and the resulting concentrated sulfuric acid solution of the diazo compound (not diluted with ice) is added slowly, with stirring and ice cooling, to a solution of 15.5 grams of β -naphthol in 400 cc. alcohol. The addition is made at such a rate that the temperature does not rise above 5°C. Coupling begins immediately and is complete in a few minutes after all of the diazo compound has been added. Stirring is continued for 1 hour, and then the dye, which has separated completely, is filtered off with suction and washed with alcohol until drops of the filtrate appear colorless (about three washings). The dye is then washed with hot water until the washings are

⁸⁷ M. L. B., Ger. Pat. 257,488 (1913) [*Frdl.*, 11, 452 (1912–1914); *C.A.*, 7, 2690 (1913)]; and Ger. Pat. Applic. F 33,190 (1913) [*Frdl.*, 11, 455 (1912–1914)].

⁸⁸ Lauch (Akt.-Ges. Anilin-Fab. Berlin), Ger. Pat. 217,266 (1909) [*Frdl.*, 9, 418 (1908–1910); *C.A.*, 4, 1242 (1910)].

neutral, dried in a steam heated oven, and powdered. The yield is 32 to 33 grams (95 to 98 per cent of the theoretical amount) of shiny, orange-red powder which is almost completely insoluble in water and only slightly soluble in the common organic solvents.

Technical Observations. Permanent red 2G (lithol fast orange R) is, like Hansa yellow, a valuable pigment color having outstanding fastness to light and very good oil and spirit fastness.

For laboratory preparations, the procedure described above — coupling in alcohol solution — is the simplest and surest method for obtaining a pure dye whose color strength corresponds to present strict specifications. The use of an excess of β -naphthol greatly accelerates the coupling reaction and thus prevents decomposition of the diazo compound.

Large scale preparations are usually carried out with an aqueous emulsion of β -naphthol prepared by precipitating the naphthol from a caustic alkali solution containing a dispersing agent (e.g., a sodium isopropyl naphthalenesulfonate) by slow addition of hydrochloric or sulfuric acid. In any case, the coupling reaction must be carried out in strongly acid solution, or dull brownish dyes are obtained which are entirely unusable.

Helio Bordeaux BL⁸⁹

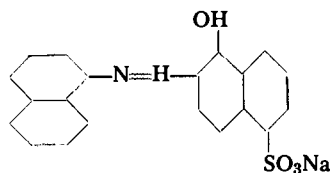

(a) Preparation of the Sodium Salt

14.3 grams (0.1 mole) of α -naphthylamine is dissolved by boiling in a mixture of 280 cc. water and 10 cc. concentrated hydrochloric acid, and the solution is cooled under the tap with shaking so that the naphthylamine hydrochloride crystallizes out in as finely divided a state as possible. An additional 75 cc. concentrated hydrochloric acid is added, the solution is cooled further, and then 250 grams of crushed ice is added. With vigorous shaking, 7.1 grams of dry, powdered sodium nitrite is now added *in one portion*, and shaking is continued for the short time required for all of the naphthylamine hydrochloride to go into solution. After 15 minutes, the clear, nonfoaming, light brownish-yellow solution, which should still give a very weak nitrite test, is filtered to remove the slight residue. The filtrate is run directly into a stirred, ice-cooled solution of 27 grams of sodium 1-naphthol-5-sulfonate (96 per cent pure) in 200 cc. water. The mixture is cooled in ice and

⁸⁹ Ger. Pat. Applic. F 28,279 (1910) [*Frdl.*, 10, 946 (1910-1912)].

stirred for 30 minutes. The yellow-brown, crystalline precipitate is then filtered off with suction, washed with ice water, and mixed with 500 cc. ice water. The resulting suspension is cooled in ice, and to it is added, with vigorous stirring, 80 cc. 2 *N* soda solution, the addition being made in such a way that each drop of the soda solution is immediately dispersed throughout the mixture. The coupling reaction is completed when all of the soda solution has been added. The reaction mixture at this point should give a distinct blue test with litmus paper, but should not turn phenolphthalein paper red. The cooling bath is now removed, and the mixture is warmed slowly to 80–90°C. with stirring, whereupon the originally dark brown, gelatinous dye rapidly becomes crystalline. Saturated, calcium-free salt solution, in an amount equal to one tenth of the volume of the reaction mixture, is now added, and the mixture is filtered hot with suction. The precipitate is first washed thoroughly with hot, calcium-free salt solution (about 5 per cent), and then the salt is washed out with cold water. The product is dried in a steam heated oven. The yield is about 37 grams or 92 per cent of the theoretical amount.

(b) Preparation of the Calcium Lake

10 grams of the dye prepared above is boiled under reflux with 250 cc. water and 25 cc. 2 *N* sodium hydroxide until solution is complete. The solution is cooled and filtered through a fluted filter. The filtrate is added *slowly* to a vigorously stirred solution, held at 25–30°C., containing 8 grams of crystalline calcium acetate and 30 cc. 2 *N* acetic acid in 500 cc. water. Each drop of the solution added should immediately produce a very finely crystalline, shiny red precipitate. When the addition has been completed, the mixture is warmed 80–90° and filtered hot with suction. The precipitate is washed thoroughly with hot water and dried in a steam heated oven. The yield is quantitative.

Remarks. Helio Bordeaux BL, which is rather difficultly soluble even in the form of its sodium salt, gives a completely insoluble calcium salt having a bright blue-red color. This calcium salt possesses, to a high degree, the properties required by the color lake industry, and is especially valuable for the preparation of printing inks. Its color purity, however, is adversely affected by the slightest impurity. In order to prevent the formation of such detrimental impurities, it is necessary to carry out the diazotization of the α -naphthylamine in such a way that no trace of aminoazonaphthalene or its diazo compound is formed. This is accomplished by using an unusually large excess of hydrochloric acid. Furthermore, the coupling reaction is not carried out in the usual manner, using a solution which is alkaline from the beginning. Instead, the acidic mixture of diazo compound and coupler is gradually neutralized; this procedure prevents partial coupling in the 4 position. Since, on mixing the diazo compound and coupler in acid solution, the difficultly soluble α -naphthyldiazonium salt of 1-naphthol-5-sulfonic acid separates

in good crystalline form, it is recommended that this salt be filtered off, thus eliminating the excess acid. The conditions under which the sodium salt of the dye is converted to the calcium salt are of real importance in the precipitation of the lake.

The 1-naphthol-5-sulfonic acid is prepared⁹⁰ by alkali fusion, at 160–190°C., of naphthalene-1,5-disulfonic acid (see page 219); it can also be prepared by the Bucherer reaction from 1-naphthylamine-5-sulfonic acid (see page 214).

Single Coupling Reactions with Amines

p-Aminoazobenzene from Aniline

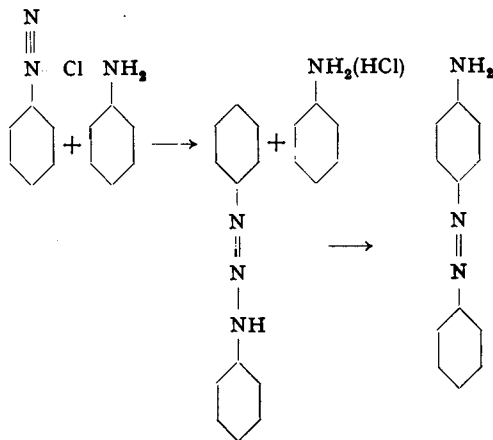

A solution of 28 grams (0.3 mole) of aniline in 350 cc. 2 *N* hydrochloric acid is externally cooled to about 20°C. and then to 0° by the addition of crushed ice. The solution is diazotized by the addition of a solution of 22 grams of technical sodium nitrite in 150 cc. ice water. The addition of the nitrite solution can be completed in less than 1 minute. The resulting diazo solution must be clear, any cloudiness indicating lack of sufficient acid. The diazotization is complete after about 10 minutes (Congo red and starch-iodide tests).

To the diazo solution is added a solution made from 31 grams of aniline, 200 cc. water, 100 grams of ice, 40 cc. 2 *N* acetic acid, and 120 cc. 2 *N* hydrochloric acid, and the mixture is allowed to stand for 10 minutes. A solution of 50 cc. 25 per cent ammonia in 400 cc. water is then added, with continuous stirring, at such a rate that the reaction mixture stays distinctly acid to litmus at all times. The ammonia should be added below the surface of the reaction mixture. The addition requires 2 to 3 hours, after which the reaction mixture gives no test for diazotized aniline with H acid solution. The yellow diazoamino com-

⁹⁰ Ewer and Pick, Ger. Pat. 41,934 [*Frdl.*, 1, 398 (1877–1887)].

pound precipitates in an easily filterable form. It is filtered off and washed with distilled water. The filter cake weighs 120 to 170 grams.

Rearrangement of the Diazoamino Compound. The precipitate is stirred with 140 grams of aniline. The solid dissolves rapidly, and the water, which was retained in the diazoaminobenzene, separates on the surface of the oil and is removed by a small pipette. 10 grams of aniline hydrochloride is then added, and the mixture is heated slowly, with continuous stirring, to 30°C. on a water bath. After 2 hours, the temperature is carefully raised to 40° (not higher) and held there overnight. On the next day, a small portion of the mixture is heated to 100° in a test tube. If the rearrangement is completed, no nitrogen is evolved and no odor of phenol is detectable. If the reaction is not complete, the mixture is heated for 1 hour at 50°, but this is usually not necessary.

The oily mixture is poured into a well stirred solution of 200 cc. concentrated HCl in 300 cc. water. The hydrochloride of aminoazobenzene separates as a graphite-like precipitate and is filtered off and washed twice on the funnel with acidified water (4 cc. HCl in 100 cc. water). The resulting material is quite pure. It can be recrystallized from about 3 liters 1 per cent hydrochloric acid. In practice, the dilute acid from this recrystallization is used for three or four successive batches in order to minimize losses. It is often observed that the aminoazobenzene hydrochloride separates first as red crystals which are rapidly converted to the graphite-like form. The pure salt, dried at 50–55°, weighs 49 to 50 grams, which is about 70 per cent of the theoretical amount.

The free base can be prepared by digesting the hydrochloride with dilute soda solution or ammonia. Generally, however, the compound is used in the form of its hydrochloride.

Aminoazotoluene is prepared by the same method in even better yields.

Fast yellow is the disulfonic acid of aminoazobenzene. The first sulfonic acid group enters predominantly the position para to the azo group, yielding a yellow wool dye which has only moderate fastness. When a second sulfonic acid group is introduced, it is forced to enter a position ortho to the amino (or azo) group, and the resulting dye has very much higher light fastness.

This sulfonation is effected very easily. Dry aminoazobenzene hydrochloride is added to 3 parts of 25 per cent oleum, and the mixture is stirred at 25°C. until a test sample dissolves in soda solution. The temperature is then raised to 40° and the mixture is held at this point, with good stirring, for about 5 hours or until a test sample dissolves completely in a large volume of water. The mixture is poured onto 6 parts of ice, and the monosodium salt of the disulfonic acid is salted out by the addition of 200 grams of salt per liter of solution. The flesh-colored precipitate is filtered off and washed thoroughly with 15 per cent salt solution, and the filter cake is then stirred with a small amount of water at 50°. Enough soda is added to make the color of the solution a pure yellow. The amount of soda required depends on the thoroughness of washing. The fast yellow need not be salted out, but the

solution can be evaporated to dryness at 90°. The product weighs about twice as much as the starting material.

Aminoazobenzene is prepared industrially in large enameled kettles of 300- to 400-liters capacity. The reaction mixture is acidified in the usual wooden vats and the aniline-containing mother liquor is worked up to recover the aniline (about 15 per cent loss) by adding lime and steam distilling. Claims to the contrary notwithstanding, fast yellow is not as fast to light as tartrazine and is much less fast than the pyrazolone dyes which have a sulfo group ortho to the azo group.

Aminoazobenzene is an important starting material for many disazo dyes. When it is diazotized and coupled with phenols and other couplers, secondary disazo dyes are formed. The first of these dyes, that from aminoazobenzenedisulfonic acid and β -naphthol, was Biebrich scarlet, and the whole group of dyes is generally referred to as the Biebrich scarlet type. Diazotization of aminoazobenzene requires several hours. The freshly prepared hydrochloride is suspended in 5 parts of water, and 150 grams of hydrochloric acid is added for each mole of the salt. A small test run should be made at greater dilution to determine the amount of nitrite required. The diazotization is done at 10–14°C., and large scale preparations frequently require a whole day. The completed diazotized mixture is either used immediately or is cooled to 0° by the addition of ice.

Aminoazobenzene, like aniline, can be condensed with dinitrochlorobenzene. The product is phenylazodinitrodiphenylamine, an insoluble, beautifully crystalline material which can easily be converted to the monosulfonic acid by the action of 100 per cent sulfuric acid. This nitroazo dye (azo flavine FF) is very similar in structure to azo yellow G, described on page 276, but is superior to the latter in that it is a more homogeneous product and does not lose nitrous acid on heating. For these reasons, it is preferred by some silk dyers over the ordinary azo yellow even though it is more expensive.

Azo flavine FF:

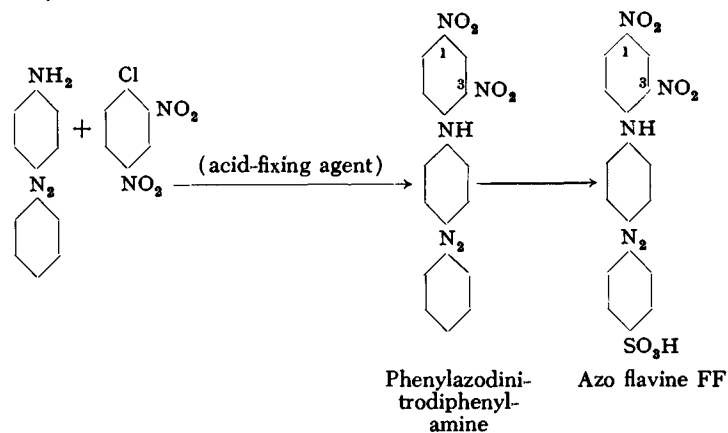

(a) *Condensation of Aminoazobenzene with Dinitrochlorobenzene.* A mixture of 100 grams (dry weight) of moist aminoazobenzene hydrochloride, 100 grams of dinitrochlorobenzene, and 250 grams of crystalline sodium acetate in 600 grams of 90 per cent alcohol is heated under reflux, with stirring, for 6 hours. The condensation product separates as reddish brown, glistening crystals which are filtered from the hot solution and washed with alcohol. The material, after drying at 100°C., weighs about 115 grams.

out without alcohol, but the product contains so much unreacted diphenylamine that the subsequent nitration of the dye is difficult. It is insoluble in water so the coupling reaction must be done in water-alcohol mixture. Under certain conditions, the reaction can be carried

(b) *Sulfonation.* One part of the condensation product and three parts of 100 per cent sulfuric acid are stirred at 30°C. for 1 hour. The temperature is then raised slowly to 45° and held at this point for 1 to 2 hours, until a test portion of the mixture is poured into 6 parts of water, and the dye is salted out, filtered off, and washed with 15 per cent salt solution. The acid is then dissolved in a small amount of hot water containing the necessary amount of soda. From this solution, the sodium salt is salted out by adding 15 per cent of salt (based on volume). The precipitate is gelatinous at first but rapidly becomes crystalline and easily filterable. The yield of dye from 100 grams of condensation product is about 125 grams.

Azo flavine FF has about the same tint as tropaeoline and the high acid stability of the highly nitrated azo yellow.

Tropaeoline or Orange IV and Azo Yellow from Sulfanilic Acid and Diphenylamine

The reaction of diazotized sulfanilic acid with diphenylamine is an interesting example of coupling in mineral acid solution. It is not possible to carry out the reaction in neutral or alkaline solution because diazosulfanilic acid is immediately decomposed by soda and, surprisingly, does not react at all in neutral solution. Furthermore, diphenylamine coupling in alcohol solution is preferred, therefore, because the better yield compensates for the small loss of alcohol.

As already mentioned, the presence of diphenylamine as an impurity interferes with the nitration of orange IV, and other impurities have the same effect to a still greater degree. If tropaeoline is to be converted to azo yellow, it is essential that the tropaeoline acid be very pure. Small amounts of impurities lower the yield by 30 to 50 per cent. If the dye acid is pure, however, the nitration is not at all critical. The process is interesting in that the nitro compound is produced through nitrosoamine and nitroamine intermediate stages. The tropaeoline is nitrosated with nitrous acid and the nitroso compound is oxidized with very dilute nitric acid, going through an intermediate nitroamine which rearranges to the nitro compound under the influence of mineral acid. This rearrangement is exactly similar to that of phenylnitroamine into *o*-nitroaniline (Bamberger). The same type of reaction is involved in the preparation of methylene green (*q.v.*).

Tropaeoline is widely used as a wool dye, giving pure tints and having adequate fastness to light and washing. It also has the property of increasing, to a considerable degree, the intensity of color produced by other dyes. This property is used especially in the widely used acid

black 4B, which is a mixture of about 45 per cent each of naphthol blue-black B and naphthylamine black D and 5 per cent each of tropaeoline and fast red AV. Attempts to replace the tropaeoline in this mixture by other yellow dyes have shown that only metanil yellow, prepared from metanilic acid and diphenylamine, has the same effect. The intensification of color is as much as 30 per cent.

Azo yellow is acid fast and can be used satisfactorily for dyeing tin phosphate weighted silks. It is indispensable for producing water fast yellow and brown tints.

(a) *Tropaeoline or Orange IV*

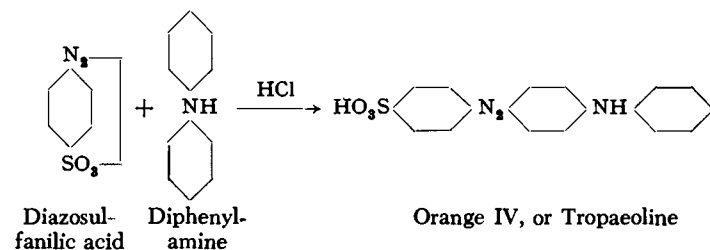

A solution of 52 grams (0.3 mole) of sulfanilic acid in 300 cc. water containing 16 grams of soda ash is boiled to steam out any aniline which may be present. The solution is filtered to remove insoluble impurities and acidified with 35 grams of concentrated sulfuric acid. The temperature is lowered to 12°C. by external cooling, and 22 grams of sodium nitrite, dissolved in a small amount of water, is added. After 1 hour, the difficultly soluble diazosulfanilic acid is filtered off, rinsing the container out with the mother liquor. (Diazosulfanilic acid is harmless when moist, but is extremely explosive when dry.) The crystals are then stirred into a paste with 250 cc. 90 per cent alcohol, and the mixture is cooled to 12°. (The alcohol must not be denatured with pyridine bases; benzene has no deleterious action.) 38 grams of finely powdered diphenylamine is added. No dye formation occurs. The vessel is covered with a pasteboard lid or a lead plate, and 12 grams of concentrated hydrochloric acid is added with good stirring. The temperature is maintained at 12° for 1 hour, 14° for 2 hours, and 18° for 2 hours, after which the water bath is warmed to 35°. The dye which has splashed up on the walls of the beaker is washed down with alcohol. No generation of gas should occur during the reaction. If possible, the mixture is stirred for an additional 6 hours and allowed to stand overnight. It is then diluted with 1 liter water at 50°. The tropaeoline acid,

which is insoluble, is filtered off and washed thoroughly with water until the washings are pure yellow in color. When the acid is removed from the funnel, it is found to have a remarkable property; the apparently solid mass becomes fluid when it is worked. This property is regarded in the plant as a sure indication of purity, the more fluid the paste formed from the solid press cake, the purer the product. The blue gray paste is stirred with 200 cc. water, and the mixture is heated to boiling and treated with 30 grams of potassium carbonate. The potassium salt of the dye crystallizes out completely within 24 hours and is filtered off and dried at 100°C. About 75 grams of concentrated product is obtained. (The sodium salt is difficultly soluble and poor in appearance; for this reason it is not used as a dye.)

(b) *Azo Yellow (Indian Yellow, Helianthine, etc.)*

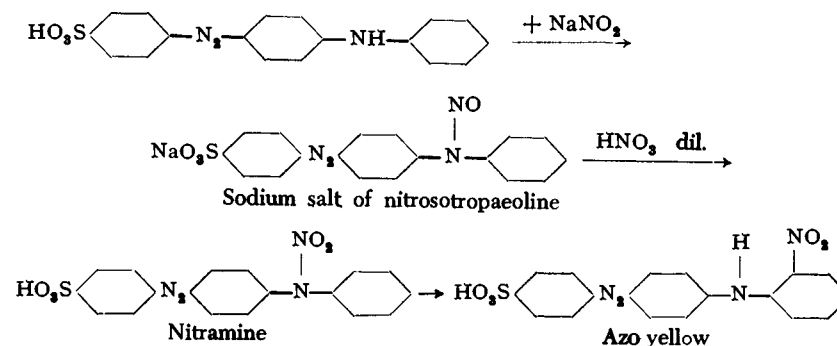

The freshly prepared, well washed tropaeoline acid is stirred with 300 cc. water and treated at 5°C. with 16 grams of 100 per cent sodium nitrite. Very slow stirring should be used since any foam that is formed causes difficulty in the subsequent nitration. After 2 hours, during which the light yellow nitrosoamine precipitates, 40 grams of 60 per cent nitric acid is added and stirring is continued for 2 hours. The temperature is then raised carefully to 68°. The mixture begins to foam and becomes darker in color, and all the solid dissolves in about 25 minutes. The mixture is heated for 10 minutes more at 71° and then diluted with 500 cc. water and neutralized with 25 grams of soda ash. Salt (200 grams) is added to precipitate the azo yellow. It separates in the course of a day as an orange-red, crumbly precipitate which is filtered off after 24 hours, pressed out, and dried at 60°. Higher temperatures cause decomposition. The yield is about 100 grams.

The mother liquor is always strongly colored because the nitration reaction is never clear-cut, some of the tropaeoline being converted to

nitrodiphenylamine and diazosulfanilic acid by the action of nitric acid. The formation of the diazo compound is easily recognized by placing a drop of the reaction mixture, at the beginning of the nitration, on filter paper and adding a drop of alkaline H acid solution to the light yellow ring. The red azo dye from sulfanilic acid and H acid is formed immediately.

The azo yellow prepared in this way is quite insensitive to dilute mineral acids, but is not satisfactory for certain purposes in silk dyeing. By using more nitric acid and more vigorous conditions, grades of azo yellow are produced which are more greenish in shade and completely fast to acids.

The preparation of azo yellow G is somewhat different. The nitration is started at 40°C., and 90 grams of 60 per cent nitric acid is used instead of 40 grams. The temperature is raised to 70° in the course of 2 hours and held at this point for 2 hours more. This treatment makes the dye acid fast. At this point, the precipitate is slimy and not filterable. Salt (100 grams) is added, and the nitration mixture is diluted to 1 liter and stirred at 70° until the precipitate becomes light orange and powdery, requiring 1 to 2 hours. The mixture is then diluted further with 500 cc. water, and the process is continued as described above for azo yellow. The yield is about 95 grams.

The nitrated tropaeolines split off nitrous acid when dissolved in hot water and this acid attacks the copper equipment used by the dyers. There is a demand, therefore, for a nitrous acid-free azo yellow which is prepared in the following way. The freshly filtered azo yellow is heated to 90°C. with 4 parts of water, splitting off most of the nitrous and nitric acids. After about 3 hours, 5 per cent sodium bisulfite solution is added to remove the last traces of nitric acid. The mass gives off red fumes and foams strongly, so the process must be done in large vats. This treatment always results in a loss of 15 to 20 per cent of the dye. (See also azo flavine FF, page 272).

Technical Observations. The diazotization and coupling of sulfanilic acid are carried out in large enameled vessels. Thick glass rods carried in wood shafts which do not reach to the liquid level, are often used as stirrers. The diazosulfanilic acid is filtered off with suction (see Fig. 26, page 150). If the tropaeoline acid is of good quality, it is very fluid and can easily be pumped out of the coupling vessel. The moist tropaeoline acid from 38 kilograms of diphenylamine should weigh just about 200 kilograms after washing and strong pressing in the filter press. A variation of 10 kilograms, more or less, in this weight shows that impurities are present. The alcohol is recovered and rectified after neutralizing with soda; the loss in one operation is about 15 per cent.

The nitration is carried out in pitchpine vats of about 2500-liter capacity. They are equipped with good hoods (see Fig. 56, page 376) and last over a year. All parts of the equipment which come in contact with the vapors driven off during the heating operations should be covered with wooden boards held in place by wooden pegs.

Secondary Disazo and Polyazo Dyes

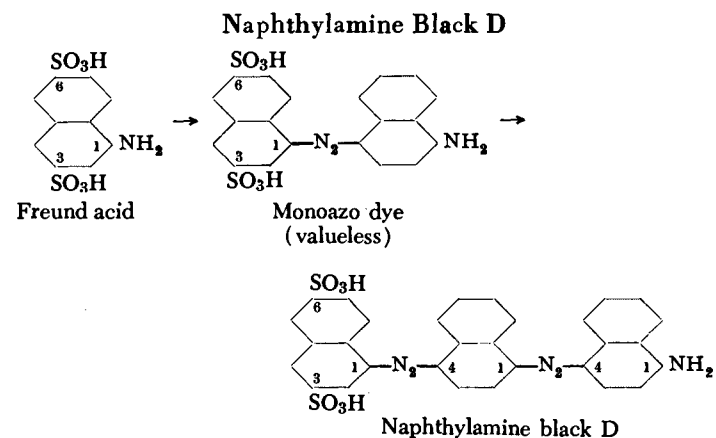

One-tenth mole of Freund acid (mol. wt. 325; acid sodium salt, $C_{10}H_8O_6S_2NNa$) is dissolved in 300 cc. warm water containing 5.6 grams of soda ash. (Freund acid is usually only 75 to 80 per cent pure since it must be precipitated with large amounts of salt because of its high solubility.) The solution is allowed to cool to about 30°C., and enough ice is added to lower the temperature to 0°. 30 cc. concentrated hydrochloric acid is then added. Usually, part of the sulfonic acid is precipitated. With good stirring, a solution of 7 grams of technical sodium nitrite is added over a period of 5 to 10 minutes, keeping the temperature below 6°. The diazotization is complete when the tests for acid (Congo red) and nitrous acid (starch-iodide) persist for 5 minutes.

Freund acid, like many other amines with negative groups (NO_2 , SO_3H , Cl), gives a positive test with starch-iodide after a short time, even though diazotization is incomplete. When diazotization is complete, however, the test should appear within one-tenth of a second. The test with the sulfone reagent (footnote, page 243) is easier for the beginner.

A solution of 14.3 grams of pure α -naphthylamine in 12 cc. concentrated hydrochloric acid and 200 cc. boiling water is allowed to cool to 50°C. with continuous stirring. Usually, a small amount of the hydrochloride separates. This amine solution is poured into the diazonium solution in a thin stream, keeping the temperature of the mixture below 5° by the addition of finely crushed ice. The mixture is stirred for 3 hours, and then a solution of 10 grams of soda ash is added over a period of 2 hours. The reaction mixture is then allowed to stand overnight. On the following day, 30 grams of concentrated hydrochloric acid is added, the temperature is lowered to 0° by the addition of about 300 grams of

ice, and the monoazo dye is diazotized by adding a solution of 6.8 grams of sodium nitrite in 50 cc. water. The diazotization requires about 15 minutes at 0–5°.

The test for complete diazotization is made,* and then the solution is treated with 14.3 grams of α -naphthylamine exactly as described above, again adding 10 grams of soda ash after 3 hours. After an additional 5 hours, a solution of 35 grams of soda ash in 100 cc. cold water is added over a period of 30 minutes, and after 1 hour more the mixture is heated slowly to 80°C. Salt is then added (18 per cent based on the volume). The naphthylamine black precipitates in an easily filterable form and is filtered, pressed, and dried. The dry dye weighs about 70 grams. A 4 per cent dyeing on wool from weak sulfuric acid solution is deep black with some brownish tinge.

Technical Observations. The preparation of naphthylamine black D can be done in various ways. Many industrial chemists prefer to salt out the diazo compound of the monoazo dye and filter it off to purify it. This has the advantage of removing unchanged α -naphthylamine and preventing the formation, in the final product, of the insoluble dye (which is not fast to rubbing):

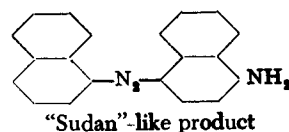

The tint of the dye prepared by this method is decidedly purer and stronger. The separation of the diazo compound is especially important when cotton dyes are to be prepared from it, since impurities are especially detrimental in subsequent steps. For example, an extremely light fast cotton dye of the Sirius blue type is prepared by coupling the diazo compound with *m*-amino-*p*-cresol ether and subsequently coupling this product with J acid:

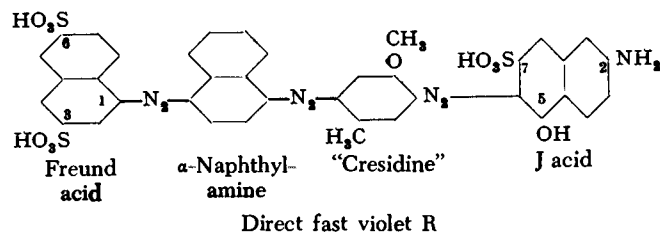

Direct fast violet RR is formed if *m*-toluidine is used in place of cresidine (aminocresol ether).

The diazo compound is dark colored, and usually it is not possible to test the solution directly with starch-iodide paper. Instead, a drop of the solution or suspension is placed on a small pile of salt resting on a filter paper. The colored materials are precipitated by the salt, and the test papers for mineral acid and nitrous acid are pressed against the back side of the filter paper.

Naphthylamine black is one of the most important azo dyes since it has high color strength and is relatively fast to light as are most of the dyes of the Biebrich scarlet type. It is not entirely fast to boiling and hence its solutions, especially if alkaline, should not be boiled unnecessarily. There is a large number of similar dyes on which data are given in textbooks and in the excellent tables of Schultz. Regarding the manufacture of these dyes, it should be noted that hydrochloric acid which contains much sulfuric acid should not be used in dissolving α -naphthylamine, since α -naphthylamine sulfate is very insoluble. In place of soda (carbonate), sodium formate can be used for the neutralization in the coupling reaction. The formate is cheaper than sodium acetate.

Benzo Light Blue 2 GL or Sirius Light Blue G *

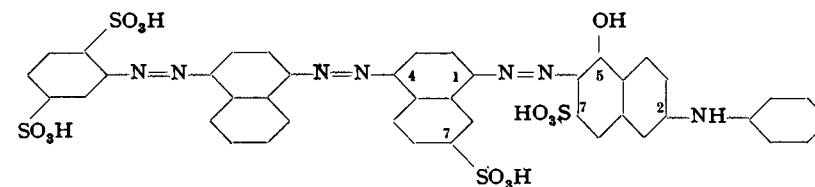

(a) Aniline-2,5-disulfonic Acid — α -Naphthylamine

The amount of aniline-2,5-disulfonic acid (monosodium salt, see page 106) corresponding to 50 cc. 1 *N* nitrite† is dissolved in 150 cc. hot water, and the solution (filtered if necessary) is treated with stirring with 8 cc. 30 per cent hydrochloric acid. The solution is cooled to 0°C. and 17.5 cc. 20 per cent sodium nitrite solution is added rapidly. The diazotization takes about 15 minutes.

The coupling reaction is carried out most conveniently in the laboratory using an aqueous alcohol solution since α -naphthylamine hydrochloride is rather difficultly soluble.‡ The diazo solution, therefore, is diluted with an equal volume of 96 per cent alcohol, and a solution of 7.15 grams of freshly distilled α -naphthylamine in 100 cc. alcohol is added very slowly to the well stirred diazo solution. If the addition is made too rapidly, a considerable part of the reactants is occluded by the precipitated dye and made inaccessible for the reaction. The very thick paste is allowed to stand overnight and then the dye is filtered

* The benzo light dyes have more recently been sold under the name, Sirius Light.

† It is essential to determine the purity of the starting materials. Anilinedisulfonic acid and naphthylaminesulfonic acid are analyzed by titration with nitrite, phenyl- acid by titration with diazobenzene (see Analytical Section, pages 386–390).

‡ It is possible, with suitable precautions, to achieve good results without using alcohol. The α -naphthylamine is dissolved in a boiling mixture of 28 cc. 2 *N* hydrochloric acid and 100 cc. water, and the solution is filtered if necessary and allowed to cool to about 50°. Before the hydrochloric acid begins to crystallize out, the solution is poured rapidly into the diazo solution containing ice, and then a solution of 7 grams of crystalline sodium acetate in 20 cc. water is added slowly.

off. It forms a brownish red, bronzy paste, which is not dried for subsequent steps. It must, however, be freed from any residual α -naphthylamine. To this end, the dye is dissolved in 300 cc. warm water containing the calculated amount of soda, and the resulting solution is cooled to 0° and held there for 1 hour. The α -naphthylamine separates and is filtered off. The filtrate is used directly in the next diazotization.

**(b) Aniline-2,5-disulfonic Acid — α -Naphthylamine —
1-Naphthylamine-7-sulfonic Acid**

The filtered solution of the monoazo dye from (a) is treated with 22 cc. 20 per cent sodium nitrite solution (30 per cent excess is used; the excess sodium nitrite assists in bringing about complete diazotization), and the resulting diazo solution is added from a dropping funnel to a well stirred, cooled (10°C., but not lower) solution of 30 cc. concentrated hydrochloric acid and 150 cc. water. This operation can be carried out conveniently by first adding, in one portion, about one-tenth of the dye solution and waiting until it is completely diazotized as shown by a sudden change in color from violet to brown. Once the reaction has been started in this way, it proceeds easily and rapidly on further addition of the dye solution. The diazotization is completed in about 2 hours. The mixture can be tested for complete diazotization of the monoazo dye by coupling a sample with β -naphthol in soda solution. If diazotization is complete, a deep, pure violet color results. If, on the other hand, the reaction is incomplete, a dirty, reddish color is formed, and an additional 2 to 3 cc. 20 per cent sodium nitrite should be added and stirring continued for a while. The diazo compound is then salted out by adding 15 per cent of salt (based on the volume of the solution), and filtered off after adding a few small pieces of ice. The precipitate is washed three times with 15 per cent salt solution to remove all of the excess nitrous acid. The brownish yellow paste of the diazonium salt should be protected from light and heat or it will darken rapidly. The mother liquor is dark colored and gives no coupling reaction with β -naphthol.

To prepare the disazo dye, an amount of 1-naphthylamine-7-sulfonic acid (Cleve acid) equivalent to 50 cc. 1 N nitrite solution is dissolved in 150 cc. water containing the necessary amount of soda, and the solution is made weakly acid to Congo red by the addition of dilute hydrochloric acid. To the resulting suspension is added, slowly and with stirring, a slurry of the diazo compound in 300 cc. ice water. At the same time, a concentrated sodium acetate solution is added from a dropping

funnel at such a rate that the reaction mixture is kept weakly acid to Congo red. The reaction mixture becomes a deep violet in color. After 5 to 7 hours, the acid is completely neutralized with sodium acetate solution, and the mixture is allowed to stand overnight. The resulting dye must be salted out of acid solution because of its high solubility. The mixture is heated to 50°C., 20 per cent of salt (based on volume) is added, and the mixture is made strongly acid to Congo red by the addition of 15 per cent hydrochloric acid. The dye is precipitated as a blue powder and is filtered off; it is purified by solution in 500 cc. water containing soda and reprecipitation by 100 grams of salt and 15 per cent hydrochloric acid.

(c) Preparation of the Trisazo Dye

A paste is made of the reprecipitated disazo dye with 75 cc. 2 N soda solution and 150 cc. water, the equivalent of 3.5 grams of pure sodium nitrite is added, and the mixture is heated to 80°C. to form a clear solution. The solution is cooled to about 60° and added, over a period of 30 minutes with good stirring, to a mixture of 30 cc. concentrated hydrochloric acid and 200 cc. water. A total of 300 grams of ice is added from time to time to keep the temperature below 8°. The completely clear solution of the diazo compound which is formed is added, in the course of 1 hour, to a solution containing the equivalent of 15 grams of pure phenyl-J acid in 300 cc. water containing 25 grams of soda ash, maintaining the temperature at 0° by the addition of ice. (The large amount of soda is used so that bicarbonate is formed in the coupling reaction and no foaming occurs due to generation of carbon dioxide.) Stirring is continued for 1 hour, and the mixture is then allowed to stand overnight. On the next day, the mixture is heated to boiling, treated with 15 to 20 per cent of salt (based on volume), and filtered at 80°. The lustrous bronzy paste is washed with 5 per cent salt solution and dried at 100°. The mother liquor is always very deeply colored and contains some phenyl-J acid; this excess is necessary in order to obtain a good yield. The yield of the trisazo dye is about 40 grams. It dyes a pure blue, and, if the dye has been prepared properly, the exhausted dye bath gives the same shade but lighter in tint.

Technical Observations. Dyes of this class are manufactured in the regular equipment for azo dyes as shown schematically in Figure 56, page 376. Because of the instability of the diazo compounds, it is necessary to use large enough filter presses so that the whole batch can be filtered at one time. Then it is possible to work up the diazo compound immediately after the filter press is emptied. It is also advisable to prepare these dyes in the colder parts of the year and to entrust the operations only to reliable workmen. If at all possible, each operation should be piloted by a

laboratory run using a small portion (e.g., one-thousandth) of the intermediate from the preceding step. Samples of the individual intermediates should be available in a pure state so that comparisons can be made to show whether the preparation is proceeding normally.

Disazo and Polyazo Dyes from Diamines

Bismarck Brown G and R

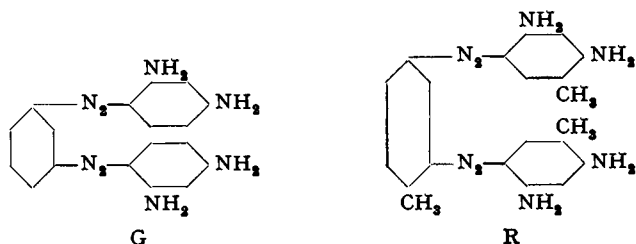

These dyes consist of various high molecular compounds of which the ones pictured above predominate. Procedures given in the literature for the preparation of these dyes are of little value because all of them call for treating an acid diamine solution with sodium nitrite. Much better results are obtained by carefully acidifying a neutral solution of the diamine and nitrite, or by adding the neutral solution, in the course of 12 minutes, to the required amount of hydrochloric acid. Furthermore, it turns out that somewhat more nitrite should be used than is called for by the equation:



The excess used is about 24 per cent in the case of *m*-phenylenediamine, and about 20 per cent in the case of toluenylenediamine. The diamine is then completely used in the dye formation as can be shown by salting out a test portion.

Bismarck Brown R (Vesuvine R, Etc.)

A solution is made by dissolving 36.6 grams of pure toluenylenediamine in 1 liter water at 40°C., and to this solution, after cooling, is added 16.5 grams of 100 per cent sodium nitrite. The volume is brought to 1600 cc. by adding ice, and a mixture of 60 grams of concentrated hydrochloric acid and 40 cc. water is added, with continuous stirring, over a period of 20 minutes. The acid should be introduced *below the surface of the liquid*. The solution immediately becomes deep brown in color and considerable nitrogen is evolved. The final temperature is

about 10°. After 8 hours, the dye is salted out with 300 grams of salt and filtered off after 3 hours more. The extremely soluble dye is rinsed onto the filter with the mother liquor. The dye is dried at a low temperature (in vacuum in the plant) and weighs, when it is dry, about 40 grams.

The dyes are applied to cotton using a tannin-tartar emetic mordant. They are cheap dyes, giving full shades which are fast to washing but not fast to light. Despite their instability to light, both dyes are widely used for cotton, silk, paper, and especially leather. Mixed with azo yellow, they give brown tints on furniture leather which have good fastness to light and rubbing. The G brand is prepared in exactly the same way, but it generally does not precipitate well and is difficult to filter. This difficulty can be overcome in part by using a larger excess of nitrite.

Chrysophenine G

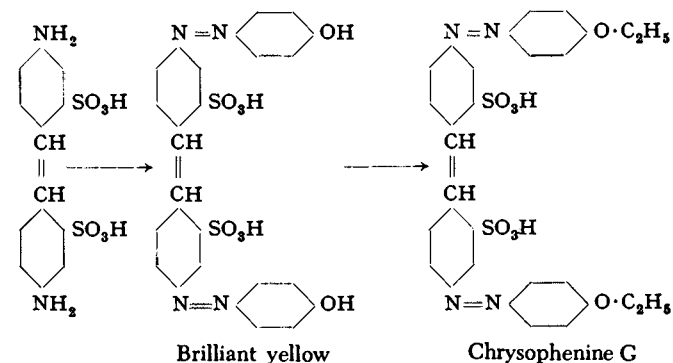

0.1 mole (37 grams) of diaminostilbenedisulfonic acid is dissolved in a solution of 11 grams of soda ash in 200 cc. water. The solution is cooled, and the disulfonic acid is precipitated by the addition of 50 cc. (about 60 grams) 30 per cent hydrochloric acid. Ice is added to bring the temperature to 5°C., and diazotization is carried out by adding 14 grams of sodium nitrite over a period of 2 hours. At the end of the reaction, a small but definite excess of nitrous acid should be present. More ice is added to bring the temperature to 0°, and 20 grams of phenol, liquified with a small amount of water, is added. The mixture of tetrazo compound and phenol is stirred well, and a solution of 50 grams of soda ash in 200 grams of water is poured in rapidly.* Ice is added in

* Contrary to the general impression, phenol does not couple readily with diazo compounds. Diazo ethers are frequently formed and the reaction is mistaken for true coupling. The procedure given here, in which the acid diazo solution is mixed with the phenol (or cresol) and the mixture treated with soda without sodium hydroxide, gives the azo dye in much better yield.

sufficient quantity to keep the mixture at about 8°. A clear solution is formed at first and after a short time, part of the brilliant yellow precipitates. After 2 hours, the mixture is heated to 70°, 100 grams of salt is added, and the amount of hydrochloric acid is added which will precipitate the dye completely but not cause the color to change from yellow to blue. The mixture is then cooled, and the dye is filtered off with suction and sucked as dry as possible. The material weighs about 180 grams.

Ethylation. The moist press cake is made up to 200 grams with water, and 50 grams of soda ash and 30 grams of 35 per cent sodium hydroxide are added. The pasty mixture is transferred to a stirring or rotating autoclave along with 250 grams of 90 per cent alcohol, and 40 grams of ethyl chloride is added in the manner described on page 148. The reaction mixture is heated with continuous stirring for 10 hours at 100°C. (maximum pressure, 6 atmospheres). The autoclave is then cooled and opened. The mixture is treated with twice its volume of 10 per cent salt solution, and the nicely crystalline dye is filtered off. If the diaminostilbenedisulfonic acid was free from diaminodibenzylidene-sulfonic acid, the dye obtained is about 20 per cent stronger than the strongest commercial product. The yield is about 70 grams of dry, concentrated dye.

Technical Observations. Chrysophenine is the most important yellow direct dye, being practically unrivaled because of its light fastness on wool, silk, and cotton, and because of its low cost. The ethylation reaction can also be carried out in aqueous solution in the presence of lime, instead of in alcohol. In either case, it is essential to precipitate the alkyl derivative immediately. The prevailing cost of alcohol determines which of the two methods is preferable. The procedure using alcohol is given here because it involves pressures of not greater than 6 atmospheres. The lime ethylation, on the other hand, requires pressures of 25 atmospheres or higher.

Chrysophenine shows a characteristic reaction with mineral acids with which it turns a beautiful blue. It is of interest, theoretically, that chrysophenine is an extraordinarily strong dye even though it contains no auxochromic groups of the type required by the Witt color theory.

The endpoint of the ethylation reaction is recognizable in the following way. A small test portion of the reaction mixture is dissolved in water and treated with a few drops of acetic acid. A few drops of this weakly acid solution are placed on a filter paper, and the yellow flecks are spotted with 10 per cent soda solution. If the ethylation is complete, no change of color to reddish yellow or red is observed. In large scale preparations, samples are withdrawn from time to time through a test cock. The ethyl chloride is added in portions of 10 to 15 kilograms, never all at once. Heating is done by means of a steam jacket. The reaction is carried out in a horizontal cylindrical boiler with a horizontal stirring mechanism whose stuffing-box must be kept cooled to prevent the alcohol from dissolving the lubricant. The ethyl chloride used amounts to about 180 per cent of that required theoretically.

Benzidine Dyes

Benzidine can be combined with all of the phenols and amines which are commonly used in preparing azo dyes. It happens that only one of the two diazo groups in tetrazobenzidine is highly reactive while the other is rather inactive. It is possible, therefore, to make not only the benzidine dyes employing two molecules of a single phenol or amine coupling component, but also, in many cases, the so-called "mixed" benzidine dyes. The mixed dyes are formed, however, only when the first coupling component is not too reactive so that the disazo dye is not formed immediately from the intermediate compound:

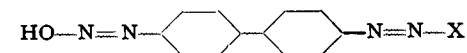

It would lead much too far afield to discuss even the most important variations of these intermediates, so only a few examples will be mentioned. Of special importance is the intermediate formed by mono-coupling tetrazotized benzidine with salicylic acid. This product is formed in high purity, since a second coupling reaction with another molecule of salicylic acid can be made to take place only with difficulty, by using an excess of sodium hydroxide, whereas the first coupling takes place in soda solution. Furthermore, no difficulties are encountered in coupling tetrazotized benzidine with one molecule of the monoazo dye from *p*-nitroaniline and H acid, or with one molecule of H acid itself in mineral acid solution. Both of these latter reactions are discussed in more detail later.

The Intermediate from Benzidine and Salicylic Acid (or from *o*-Tolidine and *o*-Cresotinic Acid) *

0.1 mole (18.4 grams) of technical benzidine is tetrazotized as described on page 261. The clear tetrazo solution is poured rapidly into a solution of 15 grams of pure salicylic acid and 40 grams of soda ash in 300 cc. water at 5°C. The orange yellow intermediate compound separates, and the reaction is completed when a drop of the reaction mixture on filter paper gives, in the colorless ring, no blue coloration with alkaline H acid solution. The mixture is stirred gently until this test for tetrazobenzidine has disappeared, which requires about 1 hour at 12°.

* *o*-Tolidine is frequently used in combination with *o*-cresotinic acid, but rarely with salicylic acid because the resulting dyes are difficultly soluble.

The resulting diazo compound has the structure:

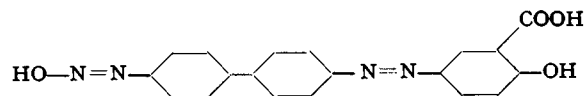

and can be reacted with various amines and phenols to produce important dyes. Thus, diamine brown M is formed by reacting the diazo compound with a carbonate solution of γ acid. It is interesting that only 85 per cent of the theoretical amount of γ acid is used in this preparation. If the intermediate diazo compound is treated with γ acid in acetic acid solution, the important diamine fast red F is formed in the course of twelve hours at 12 to 28°C. The latter dye, because of its salicylic acid grouping, dyes chrome mordanted wool in shades which are fast to milling.

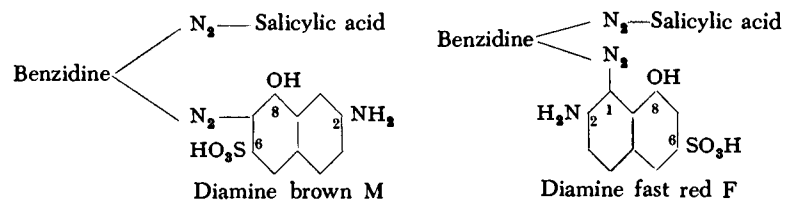

In alkaline solution, the diazo group enters the position ortho to the hydroxyl group, while in acetic acid solution, it enters the position ortho to the amino group.

Dianil Brown 3 GN

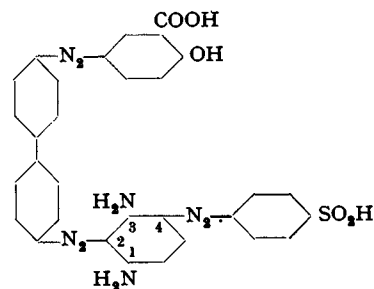

This dye is one of the most widely used direct azo dyes as it is an extraordinarily strong dye. It is not fast to acid or to light. The first step in its preparation involves the preparation of the monoazo dye, sulfo chrysoidine G:

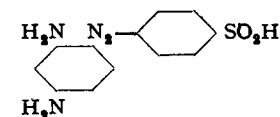

0.1 mole (17.3 grams) of sulfanilic acid is diazotized as described on page 261, and the suspension of the diazo compound, which must be weakly acid, is added slowly to 10.8 grams of pure *m*-phenylenediamine in 10 per cent solution containing 5 cc. concentrated hydrochloric acid. The coupling reaction is followed by testing the reaction mixture on filter paper with alkaline H acid solution, and the addition of the diazo compound is continued until a very weak, reddish color is formed in the test spot. At this point, the diamine has disappeared completely but azo dye formation has not yet occurred. The reaction mixture is held at 5°C. for 2 hours, and then sufficient 10 per cent soda ash solution is added to neutralize the mineral acid (about 6 grams of soda ash is required). After 3 hours, still at 5°, an additional 5.5 grams of soda ash is added, over a period of 1 hour, and the mixture is allowed to stand overnight. On the next day, 10 grams more of soda ash is added and the solution is allowed to stand for 3 hours. It is absolutely necessary to carry out this coupling of sulfanilic acid and the diamine under carefully controlled conditions or the final dye will be weak. Most of the sodium salt of the sulfo chrysoidine crystallizes out in the form of light reddish brown crystals. The total volume should be about 500 cc., but not much greater. This suspension is mixed at 10° with the intermediate compound from tetrazotized benzidine and salicylic acid (page 285), and the whole is stirred for 5 hours. The mixture is then warmed carefully to 30° and held at this point for 12 hours. It is then heated to boiling, and the dye is salted out with 200 grams of salt. The dye, which is a pure brown red in color, precipitates in an easily filterable form. The mother liquor contains a small amount of sulfo chrysoidine. The yield of dry dye is about 95 grams. It dyes cotton uniformly only if it is mixed with 10 per cent of its weight of soda ash. The amount of soda used is quite critical just as in the case of direct deep black EW (page 292).

Technical Observations. If 1,2,4-toluylenediamine is used in place of *m*-phenylenediamine, an analogous dye is formed which is somewhat more fast to acids. In this case, one of the positions para to the amino group is occupied, and hence the formula given above for the *m*-phenylenediamine dye must be correct, i.e., the second azo group must enter the position between the two amino groups, and not the position para to the —NH_2 .⁹¹

⁹¹ See, however, Schmidt and Hagenböcker, *Ber.*, 54, 2201 (1921).

If the procedure is reversed, and the diamine is coupled first with the intermediate benzidine-salicylic acid compound and then with diazotized sulfanilic acid, an isomeric dye, having the following structure, is formed:

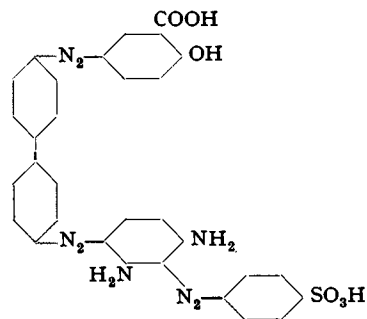

Surprisingly, this dye is worthless.

It is very important to use pure diamine in this preparation since traces of *o*- or *p*-phenylenediamine destroy a large proportion of the diazosulfanilic acid and also of the benzidine-salicylic acid intermediate. The reaction mixture foams and the dye is cloudy and weak. When pure materials are used, the yield of final dye is increased by as much as 40 per cent over that when technical diamine solutions are used.

Both of these dyes, that from *m*-phenylenediamine and that from toluenylenediamine, are used in large quantities in the preparation of compound colors.

Diamine Green B

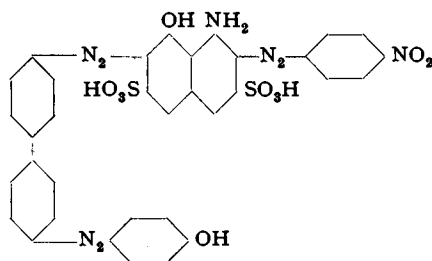

To the ice-cold diazo solution prepared from 14.5 grams* of pure *p*-nitroaniline according to the procedure on page 260, is added a cold solution of 34.1 grams of H acid and 5.5 grams of soda ash in 100 cc. water. The addition is made over a period of about 45 minutes, using thorough mechanical stirring so that no lumps are formed. The H acid combines with the diazotized *p*-nitroaniline in the course of 4 to 5 hours, forming one equivalent of hydrochloric acid. The mixture must

* This is used instead of the theoretically required 13.8 grams. This small excess is necessary because some of the diazo compound is decomposed during the long slow coupling reaction.

be allowed to stand for at least 12 hours and is then heated to 50°C. and treated with 20 grams of 30 per cent sodium hydroxide and 40 grams of soda ash. The monoazo dye, having the structure:

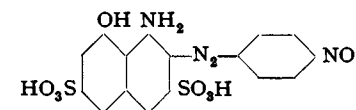

goes into solution with the formation of a blue color and is then salted out with 200 grams of salt. After a few hours, the sodium salt separates in an easily filterable form and is filtered off and pressed out. The mother liquor is deep blue in color but yields no usable dye when saturated with salt and is, therefore, discarded.

Instead of isolating the dye from *p*-nitroaniline, it can be coupled in soda solution at 5°C. with the calculated quantity of diazotized aniline to produce the important dye, naphthol blue-black B (C), having the structure:

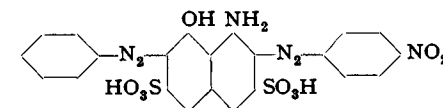

The monoazo dye is not isolated. An excess of diazotized aniline has a deleterious effect. The naphthol blue-black B is salted out at 90°C. with 15 per cent salt to yield a lustrous, bronzy product. This dye, on reduction with Na₂S at 25°, yields a valuable dark green azo dye, azo dark green, having the structure:

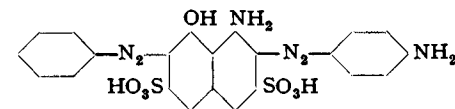

The reduced dye is precipitated after 3 hours at 50° with 15 per cent salt and a small amount of sulfuric acid; it is difficultly soluble in bicarbonate. The mother liquor is deeply colored.

It is generally true that dyes from *p*-nitroaniline can be reduced practically quantitatively, by the calculated amount of sodium sulfide, to the *p*-phenylenediamine dyes. The resulting aminoazo dyes can be diazotized, in turn, and combined with other couplers. The same aminoazo dyes are obtainable, however, by hydrolysis of the acetyl-*p*-phenylenediamine dyes. (Formyl- and oxalyl-*p*-phenylenediamine can also be used. See page 95.)

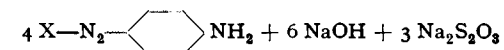
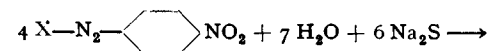

The sodium salt is dissolved at 80°C. in 500 cc. water containing 40 grams of soda ash, and the solution is cooled, with stirring, to 20°. Sufficient ice is then added to lower the temperature to 4°, whereupon part of the dye separates again in a finely divided form. To this suspension is added a solution of tetrazobenzidine, prepared as described on page 261, the addition being continued until a drop of the reaction mixture on filter paper gives a faint, but definite, blue ring with alkaline H acid solution. The coloration is not permanent at first, and more of the tetrazo solution must be added. About 18.6 grams of benzidine is used in all, and the formation of the intermediate compound requires about 30 minutes. The intermediate has the structure:

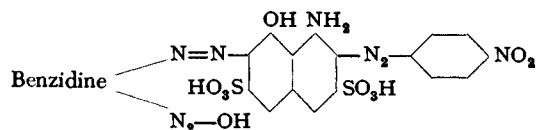

To this intermediate compound is added 12 grams of phenol, liquidified with a small amount of water, and the mixture is allowed to stand for 3 hours at 10°C., after which the temperature is raised slowly to 30° and held at this point overnight. The solution is then heated to 60°, and enough 30 per cent sodium hydroxide solution (about 40 grams) is added to dissolve all of the material. (Nitroazo dyes should not be treated with sodium hydroxide in the presence of wood or reducing materials.) The solution is treated with 150 grams of salt, and dilute sulfuric acid is added in sufficient quantity to precipitate the dye completely (test by spotting on filter paper). The dye is then filtered off, pressed out, and dried at 90°. The yield is about 110 grams. Instead of using sodium hydroxide, the solution can be heated at 90° and the dye salted out of the hot solution with 300 grams of salt. The dye obtained in this way is not so strong.

Technical Observations. In spite of its moderate light fastness, diamine green B is one of the most widely used green dyes for cotton. It is used for dyeing the insulation on telephone and other wire, and for the preparation of compound colors. When salicylic acid is used in place of phenol, the first coupling must be done with the salicylic acid, since this compound does not react satisfactorily as the second coupler with benzidine. The dye formed in this case is diamine green C. This dye is less widely used since its preparation runs less smoothly, and the dye costs more as a result. In the industry, heating is always done by blowing in steam and the resulting dyes cannot be pressed out because they pass through the filter cloths.

Direct Deep Black EW

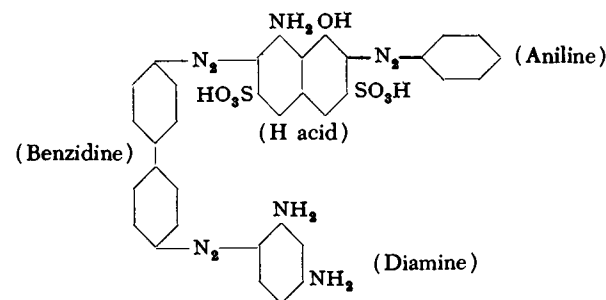

In the preparation of diamine green B, we have seen how H acid, in mineral acid solution, couples very easily with *p*-nitroaniline to form a monoazo dye in which the azo group enters the position ortho to the amino group. Benzidine, however, couples appreciably less rapidly, and it is necessary to neutralize the free mineral acid that is formed. Contrary to the statements in the patent literature, it is not possible to carry out this reaction in acetic acid solution, because H acid, in the presence of sodium acetate, couples immediately in the position ortho to the hydroxyl group. These facts have given rise to many patent suits, all of which, however, have been decided in favor of the holders of the mineral acid coupling patents.

(a) The Intermediate

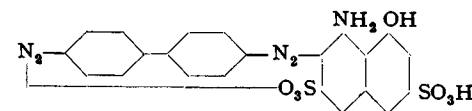

Following the procedure given on page 261, 19.2 grams of benzidine is tetrazotized, and the temperature of the resulting solution is adjusted to 10–12°C. To the tetrazo solution is added, over a period of 1 hour, the *filtered* solution of 34.1 grams of H acid in 300 cc. water containing 5.5 grams of soda ash. The H acid solution should be distinctly acid to litmus. The mixture is stirred for 3 hours at 12°, and then a solution of 5.5 grams of soda in 60 cc. water is added very carefully over a period of 2 hours, the addition being made in such a way that the reaction mixture retains a mineral acid reaction at all times. After an additional 3 hours at 12°, the reaction mixture is brought to a point where it is

just faintly acid to Congo red by the addition of a more dilute solution of soda and allowed to stand in a cool place overnight. After 12 hours, the intermediate compound has separated completely as a powdery precipitate, and the mixture gives no test for tetrazobenzidine (with H acid solution) or for H acid (with diazotized *p*-nitroaniline).

(b) *The Intermediate*

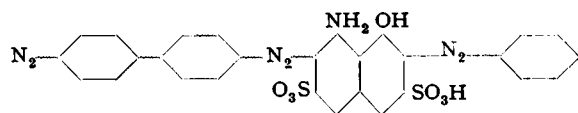

The diazonium solution from 8.8 grams of pure aniline, prepared as described on page 259, is added to the product from (a) at 5°C. If necessary, ice is added and then a solution of 26 grams of soda ash in 120 cc. cold water is poured in with thorough stirring. A clear solution is formed momentarily, and then the new intermediate compound separates. If too much soda is used, there is danger of the intermediate coupling with itself. The coupling reaction can easily be followed by spot tests on filter paper. Frequently, the test for diazobenzene does not disappear completely.

After about 15 minutes, 11 grams of pure *m*-phenylenediamine, dissolved in a small amount of water, is added to this second intermediate compound. Coupling proceeds rapidly, and part of the dye goes into solution. After 1 hour at 14°C., the mixture is carefully warmed to 50°, and 10 grams of soda ash is added. It is then treated with 120 grams of salt and acidified, with continuous stirring, by the addition of about 20 cc. concentrated hydrochloric acid to precipitate the dye. The dye is insoluble at 50° in 10 per cent salt solution containing bicarbonate, provided the solution has not previously been boiled. The product is very easily filterable, and can be dried at 100° after being pressed out. The yield is about 100 grams. The dye does not go on cotton properly unless it is mixed with 6 per cent of its weight of soda.

If *m*-toluylenediamine is used in place of *m*-phenylenediamine, deep black V is formed. This dye gives somewhat more reddish shades. In this case also, it is necessary to add some soda after warming the reaction mixture in order to obtain a filterable product.

Technical Observations. The cotton black described above is the most widely used direct black in the dye industry. It is used in dyeing all organic materials, such as cotton, half-wool, leather, etc. The dye is prepared in the largest azo dye instal-

lations, and only the purest starting materials are used. The best yields and the highest quality of product are obtained when *m*-phenylenediamine, recrystallized from water, is used.

Congo Red

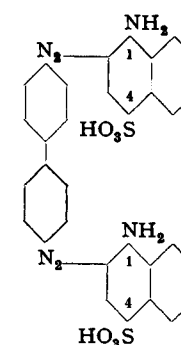

A solution, prepared by tetrazotizing 18.4 grams of technical benzidine (page 261), is mixed with a solution containing 50 grams of naphthionate and 50 grams of sodium acetate in 200 cc. water. The temperature is held at 5°C. for 1 hour, then raised slowly to 20° where it is held for 5 hours. Subsequently, the mixture is stirred at 30° for 24 hours, and then, on the third day, is heated to 55°. After the coupling has proceeded for 2.5 days, the reaction mixture is heated to boiling and treated with 40 grams of calcined magnesia, whereupon the insoluble magnesium salt of Congo red is precipitated. The salt is filtered off and washed thoroughly, thus removing all of the impurities. The washed magnesium salt is stirred into 500 cc. boiling water and the mixture is treated with 15 grams of soda ash, which precipitates the magnesium as the carbonate and dissolves the dye as the sodium salt. The hot solution is filtered, washing the magnesite with water, and the Congo red is salted out by adding 15 per cent (by volume) of salt to the filtrate. The dye is precipitated as a light red solid which, after drying, weighs about 70 grams.

Technical Observations. Congo red, the first of the benzidine dyes, is widely used despite its sensitivity to acids. It is not surpassed in beauty by any other direct dye. Congo red is manufactured by only a few firms because its low price does not allow for much margin of profit.

In large scale preparations, the coupling reaction is often carried out somewhat differently. The reaction is greatly accelerated by adding the naphthionate solution at 85°C. to the tetrazobenzidine solution. Very thorough stirring is required under

these conditions, and the operation is carried out in small batches. 8 or 10 runs can be made in one day, however. The excess naphthionate is often recovered.

In addition to Congo red, benzopurpurin 4 B, prepared from *o*-tolidine and naphthionic acid, is also of importance. In the preparation of this dye, the coupling reaction cannot be carried out at higher temperatures since the tetrazo compound from *o*-tolidine is too unstable. Benzopurpurin 4 B is somewhat less sensitive to acids than Congo red, and, like the latter, is widely used, particularly in the Orient. It is interesting that these dyes are found to be much more stable in nonindustrialized countries where the atmosphere contains little sulfuric and sulfurous acids.

Acid Anthracene Red G and Chromocitronine R

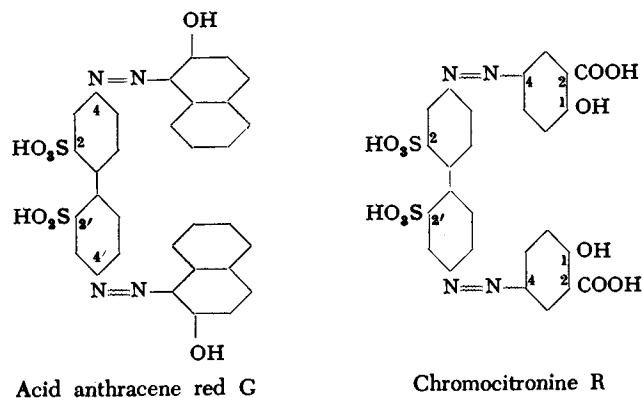

Benzidinedisulfonic acid is so insoluble that it must be diazotized indirectly by dissolving it in soda or caustic solution, adding nitrite, and adding the solution to acid.

Acid Anthracene Red G. A solution is prepared by warming 34.4 grams of benzidine-2,2'-disulfonic acid (100 per cent) with 300 cc. water containing 11 grams of soda ash. The solution is cooled to 20°C., treated with 14 grams of sodium nitrite, and is added to a mixture of 60 cc. 30 per cent hydrochloric acid, 200 cc. water, and 100 grams of ice. The temperature can go to 25° without damage, and the diazotization is complete within a few minutes. The tetrazo solution is added to a solution of 30 grams of β -naphthol prepared by using the same proportions of water, sodium hydroxide, soda, and ice as were used in the preparation of acid orange A (page 262). The reaction mixture is worked up much as in the case of acid orange A. Sometimes, however, the tetrazobenzidinedisulfonic acid separates out as an insoluble, coarsely granular, crystalline precipitate which does not react with the alkaline

naphthol solution. In this case, it is necessary to treat the ice-cold tetrazo solution with enough sodium hydroxide to form the soluble sodium diazotate which couples instantaneously with the β -naphthol. Acid anthracene red G gives shades on unmordanted wool which are fast to milling.

Chromocitronine R. The solution of tetrazotized benzidinedisulfonic acid is added at 5°C. to a solution of 32 grams of pure salicylic acid in 200 cc. water containing 80 grams of soda ash. After 12 hours, the resulting dye is salted out in the cold by adding 20 per cent of salt (based on volume). It is then pressed out, and dried at 60°.

In this case, it is unnecessary to redissolve the tetrazo compound which may separate out under certain conditions, because the chromocitronine itself dissolves immediately. It is advisable, however, especially in large scale preparations, to filter the final dye solution before the salting out operation so that the product does not cause fouling of the printing roll in calico printing where the dye is widely used. The wooden vats frequently produce splinters causing much trouble to the calico printer. Chromocitronine R is a beautiful yellow dye whose chromium lake has exceptionally high fastness to light, washing, and chlorine. Because of its high solubility, the dye penetrates deeply into cotton, giving the appearance, on thin materials, of being printed on both sides.

Special Methods

Eriochrome Flavine A⁹²

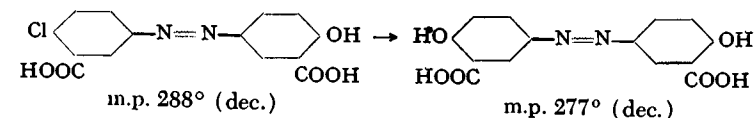

A solution containing the equivalent of 17 grams of pure chloroaminobenzoic acid, prepared, for example, as described on page 169, is acidified with 30 cc. 30 per cent hydrochloric acid and cooled to about -2°C. by addition of ice. To this solution is added, over a period of a few minutes, 35 cc. 20 per cent sodium nitrite solution. With good starting materials, the diazo solution remains colorless and clear. It is mixed with a solution of 15 grams of salicylic acid (10 per cent excess) in 300 cc. water containing 40 grams of soda ash and 15 cc. 30 per cent sodium hydroxide. After 2 hours, when the coupling reaction is completed, the mixture is heated to 80° and treated with 15 per cent (by volume) of

⁹² Kern, *Dissertation*, Zürich, 1921; Geigy, Ger. Pat. 278,613 (1914) [*Frdl.*, 12, 323 (1914-1916); *C.A.*, 9, 1847 (1915)].

salt and enough hydrochloric acid to precipitate the dye. The material is filtered off and pressed out in the screw press.

The resulting dye is of no value in itself and is carried directly into the next step. The broken-up press cake is placed in a rotating autoclave with 50 cc. 30 per cent sodium hydroxide, 200 grams of water, and 1 gram of copper sulfate. The mixture is heated, with continuous agitation, for 10 hours at 140°C (pressure, 4 atmospheres), during which time the chlorine is replaced by a hydroxyl group.

The pure reddish brown solution is filtered to remove copper oxide, and the azosalicic acid is precipitated at 80°C. by the addition of 15 per cent hydrochloric acid. The product is insoluble in water. The yield is about 28 grams, or 90 to 95 per cent of the theoretical amount. From 156 grams of pure chlorobenzoic acid, 230 grams of pure azosalicic acid can easily be obtained, whereas with impure starting materials and incorrect reduction of the nitro compound, the yield may fall to less than half this value.

For dyeing wool, the water-insoluble material is dissolved in ammonia and the solution is made distinctly acid with acetic acid. The dye is after-chromed with sodium bichromate, making the shade fuller and completely fast to boiling.

Technical Observations. Azosalicic acid is a typical example of a dye specifically designed to provide a use for a by-product. The problem here was to find a use for large quantities of *o*-chlorobenzoic acid formed as a by-product in the manufacture of *o*-sulfobenzaldehyde. The Geigy concern had about 30,000 kilograms of this by-product on hand before C. Mettler succeeded in solving the problem of its use. Azosalicic acid is the fastest yellow chrome azo dye derived from salicylic acid. It approaches the previously described chromocitronine in fastness, and, contrary to the behavior of chromocitronine, it levels well on wool. The corresponding dye from *o*-cresotinic acid is about 25 per cent stronger on wool.

The replacement of the chlorine by hydroxyl takes place under the catalytic influence of copper oxide. Instead of the oxide, "cement copper," or finely divided sheet copper, can be used equally well.

Sun Yellow G from *p*-Nitrotoluene

100 grams of *p*-nitrotoluene is added to 280 grams of 25 per cent oleum, and the mixture is heated to 100°C. while being stirred with a glass or iron stirrer. The sulfonation should be complete within 20 minutes; if necessary, additional fuming sulfuric acid is added. A test sample, mixed with water, should have no odor of *p*-nitrotoluene and should form a perfectly clear solution.

When the sulfonation is complete, the mixture is cooled to 40° and poured into a mixture of 300 cc. water and 300 grams of ice. The sul-

fonic acid is salted out in the form of the sodium salt by adding 250 grams of salt. The sulfonate is filtered off, after cooling the mixture, and pressed out well. It is advisable to use continuous mechanical stirring during the precipitation and to wash the product on the filter with 15 per cent salt solution to remove most of the sulfuric acid. The press cake weighs about 220 grams.

Condensation to Sun Yellow. The press cake is dissolved in about 400 cc. water, and enough soda is added to neutralize the residual acid. The volume is made up to 1 liter, and the solution is heated to 65°C. With continuous stirring, 200 grams of 35 per cent sodium hydroxide is added over a period of 15 minutes, and the temperature is raised carefully to 69° at the same time. The caustic solution should not be added too rapidly, or thick clumps of the insoluble sodium salt are formed which retard the condensation. Stirring is continued for 1 hour at 70°, then for 1 hour at 74°, and finally for 1 hour at 76°, taking care that the temperature does not exceed this value locally. The heating is done most satisfactorily on a water bath.

When the condensation is completed, the suspension of the dye is neutralized with about 220 grams of concentrated hydrochloric acid in such a way that the dye does not change color to a brown black. The mixture is thoroughly cooled and the dye is filtered off and dried at 80°C. The yield of pure dye is about 170 grams.

Remarks. The condensation of the sulfo derivative of *p*-nitrotoluene was first observed accidentally by Johann Walther, and further investigation of the reaction has shown that different dyes, varying in color from yellow to red, are formed depending on the nature of the reaction. If the condensation is carried out under somewhat more drastic conditions, for example, with more sodium hydroxide and at a higher temperature, the color of the dye is more greenish. Still more greenish dyes can be obtained by careful oxidation with sodium hypochlorite (sun yellow 3G, polyphenyl yellow 3G).

Reduction of these dyes leads to tints which are appreciably more reddish, going as far as reddish oranges. If, for example, the dye prepared above is only partly neutralized and reduced directly after the condensation with 40 grams of crystalline sodium sulfide (1 hour at 75°C.), followed by acidification as described above, Mikado orange R is obtained. This is a very good, light-fast cotton dye.

All of these dyes are characterized by the fact that they do not dye wool and silk from neutral baths, in contrast to the behavior of chrysofenine, but on vegetable fibers they exhibit remarkable fastness to light and washing. They are also used in coloring paper. The structures of the dyes are not known with certainty. They all give a mixture of diaminostilbene- and diaminodibenzylsulfonic acids on vigorous reduction, for example, with zinc dust and sodium hydroxide or with ammoniacal ammonium sulfide. These dyes are prepared in the plant in small concrete vats equipped with concrete stirrers. The equipment lasts many years. Copper is also very suitable, but is usually too costly.

E. DI- AND TRIPHENYLMETHANE DYES

Auramine OO⁹³

In an apparatus such as that shown in Figure 36a and b, a mixture of 127 grams (0.5 mole) of 4,4'-tetramethyldiaminodiphenylmethane (page 137), 32 grams of sulfur, 70 grams of ammonium chloride, and 1000 grams of pure sodium chloride, is heated to 110°C. It is essential that all of the materials be very finely ground and contain no water. During the course of 2 hours, the temperature is raised to 130° (oil bath temperature, about 25° higher) while a rapid stream of dry ammonia is introduced into the apparatus from a cylinder. Remaining traces of moisture are carried out by the ammonia, and at about 140° a vigorous evolution of hydrogen sulfide begins and continues for 10 to 15 hours, depending on the velocity of the ammonia stream. The temperature is raised to 175° over a period of 5 hours while stirring is continued, and the hydrogen sulfide is absorbed in concentrated sodium hydroxide. It is advantageous to build up a small pressure (about 0.2 atmosphere) in the apparatus (manometer!). The velocity of the ammonia stream should correspond to about 5 bubbles per second. The ammonia must be dried by passing it through a wash bottle containing 50 per cent potassium hydroxide solution and then through two towers containing sodium hydroxide sticks. (Ammonia and all amines combine with calcium chloride and hence cannot be dried with this reagent.)

When the evolution of hydrogen sulfide ceases, the reaction vessel is opened and the brownish yellow, powdery material is transferred to a large porcelain dish and mixed with 3 liters water to dissolve out the salt. The dye is then filtered off and dissolved in about 1500 cc. water at 60°C. Higher temperatures should not be employed because auramine is easily decomposed. The solution is filtered to remove a small residue of sulfur and Michler ketone, and is then mixed with 1 liter of the salt solution obtained as the preceding filtrate. The auramine precipitates as lustrous golden plates. The yield of pure dye is about 155 grams. It gives pure yellow shades on cotton mordanted with tannin and tar emetic.

Technical Observations. Auramine is the most important basic yellow and is highly valued because of the extraordinarily pure tints it produces. Manufacture of the dye is done in oil heated vessels, and the heating must be very carefully

⁹³ This auramine process is ascribed to Feer in the patent literature. The actual discoverer, however, was Sandmeyer. Feer, Ger. Pat. 53,614 (1890) [*Frdl.*, 2, 60 (1887-1890)].

controlled since the smallest variation reduces the yield. The purity of the salt used is of great importance. Traces of calcium or magnesium chloride, which are usually present in common salt, have a deleterious effect. The best salt is the Galician rock salt which is practically chemically pure. The ammonia, dried in towers charged with sodium hydroxide, is introduced in sufficient amount to produce a pressure of 0.5 atmosphere and is circulated by pump over the stirred salt mixture. The hydrogen sulfide is absorbed and recovered as sodium sulfide to be used in reductions. In well operated plants, the yield of auramine is as much as 132 per cent, that is, 132 kilograms of pure auramine from 100 kilograms of tetramethyldiaminodiphenylmethane. The determination of the yield is rather difficult, because only a few people are able to estimate exactly the dye strength on tanned cotton. Consequently, the dye is assayed, not by a dyeing test, but by hydrolyzing it with dilute hydrochloric acid, treating with sodium hydroxide, distilling off the ammonia into normal hydrochloric acid, and back-titrating. In many plants, however, the auramine is mixed with a known quantity of a blue basic dye, and a dyeing test is made. The resulting green tint is much easier to estimate than the pure yellow.

In addition to auramine OO, auramine G is now also manufactured, starting with monomethyl-*o*-toluidine. Auramine G gives purer and more greenish tints than the OO product. The product from diethylaniline is not manufactured because it precipitates, on salting out, in such a tarry condition that it cannot be worked up.

Auramine is used widely in dyeing cotton, but still more for paper. The Swedish match factories alone use eight carloads per year for coloring match boxes.

Malachite Green⁹⁴

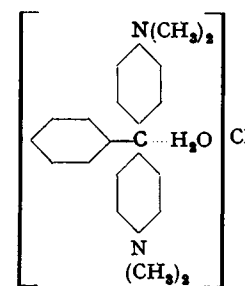

(a) *Leuco Malachite Green*

In a 300-cc. flask, a mixture of 36.3 grams (0.3 mole) of dimethylaniline, 24 grams (0.2 mole) of 30 per cent hydrochloric acid, and 10.6 grams (0.1 mole) of benzaldehyde is heated for 12 hours under reflux. The end of the condenser should be closed with a plug of cotton or glass wool to prevent excessive oxidation of the aldehyde. Vigorous stirring throughout the reaction is necessary. At the end of 12 hours, the benzaldehyde has almost completely disappeared. The mixture is treated with 12 grams of soda ash, and the excess dimethylaniline is driven off. It can easily be recovered. The leuco base remaining behind is separated from

⁹⁴ The schematic formula given for malachite green is that proposed by Fierz and Koechlin, *Helv. Chim. Acta*, 1, 210 (1918).

the water, pulverized, and washed once. The yield of dry product is about 24 grams.

(b) Oxidation of the Leuco Base to the Dye

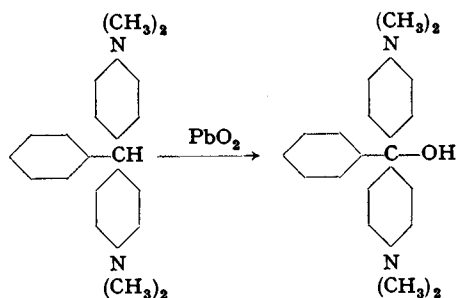

0.05 mole (16.5 grams) of the pure leuco base is dissolved in 300 cc. water and 20 grams of concentrated hydrochloric acid, and the solution is brought to 400 cc. and 0°C. by the addition of ice. To the well stirred solution is added, *in one portion*, a paste of lead peroxide made from exactly 0.05 mole (16.5 grams) of lead nitrate (see page 138). After 2 hours, a solution of 25 grams of crystalline sodium sulfate is added to precipitate the lead as the insoluble sulfate which is filtered off. The dye is then precipitated with about 15 grams of soda ash and filtered off. It usually precipitates as a tarry material which, after drying, weighs about 16 grams (100 per cent of the theoretical amount).

Recrystallization of malachite green is not easily accomplished in the laboratory, large amounts being necessary for obtaining good results. The base (120 grams) is dissolved in a hot solution of 72 grams of crystalline oxalic acid in 300 grams of distilled water, and the boiling solution is filtered to remove any insoluble impurities. To the hot filtrate is added 7 grams of ammonium oxalate, in as concentrated a solution as possible, and the mixture is allowed to stand undisturbed. Best results are obtained by placing the solution in a large bath of hot water so that it cools slowly. In the course of a day, the temperature is lowered to 70°C., and the well formed crystals are then filtered off. The mother liquor yields a further quantity of impure dye on cooling (malachite green II). The yield of the oxalate is about 1.45 parts from 1 part of the base.

Technical Observations. Malachite green is still used in large quantities for coloring tin-weighted silk, wool, and paper. Pure compound shades are obtained inexpensively by using it in mixture with other dyes, but the tints are of only moderate fastness. The dye is also used in silk and cotton printing, but does not fulfill the modern demands for fastness properties so its use in these fields is declining.

The condensation is now carried out only with mineral acids, the older zinc chloride procedures having long since been abandoned. The Doebner process, starting with benzotrichloride, is also no longer used. The reaction can be effected with either hydrochloric or sulfuric acid. Hydrochloric acid gives the more rapid condensation, but requires the use of enameled apparatus whereas the sulfuric acid condensation can be carried out in leaded containers. It is important that excessive amounts of acid are not used, since under these conditions, a side reaction occurs leading to the formation of *p*-dimethylaminobenzohydroly which, of course, cannot give the dye.

In commercial preparations, several fractions of the dye are always separated since different consumers have quite different requirements as to the appearance of the product. The oxalate of malachite green corresponds to the formula, $2 C_{23}H_{24}N_2 + 3 C_2H_2O_4$. The crystallization requires several days and frequently crystals of great beauty are obtained. The addition of ammonium oxalate to promote crystallization is reminiscent of similar procedures in alkaloid chemistry and was discovered purely empirically.

Condensation of benzaldehyde with ethylbenzylaniline, sulfonation of the resulting leuco base with oleum, and oxidation of the leuco sulfonic acid with lead peroxide, produces light green SF (yellowish). The corresponding dye from *o*-chlorobenzaldehyde is erioviridine B. Both dyes have poor light fastness but are still widely used because of their color strength.

Xylene Blue VS

Xylene blue belongs to the group of so-called patent blues which are sulfonated triphenylmethane dyes that are stable to alkali. The dyes are all characterized by having a sulfo group in the position ortho to the central carbon atom as in the following general formula:

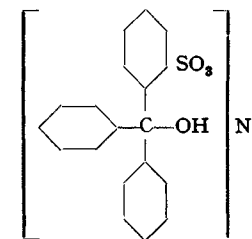

Sandmeyer first explained the relation between structure and alkali stability, and his eriochlorine was the first dye prepared to take advantage of this relationship.

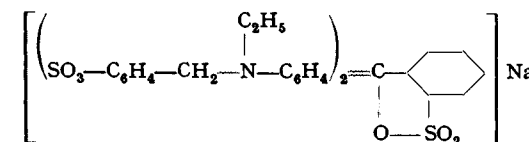

Erioglaucine A
from ethylbenzylanilinesulfonic acid
and *o*-sulfo benzaldehyde

Apparently an inner anhydride is formed between the carbinol hydroxyl and the sulfo group, and this causes the stability toward soda and caustic alkali. This assumption appears probable because dyes of the type below are entirely insoluble:

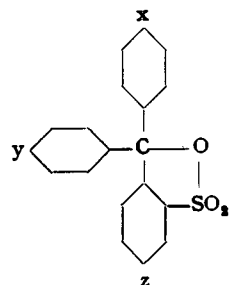
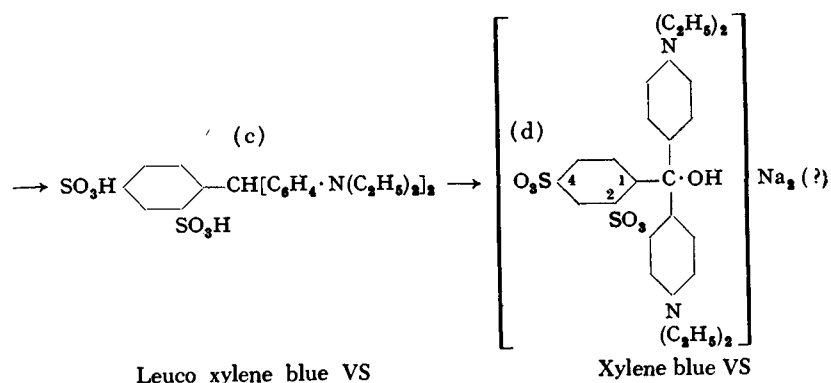
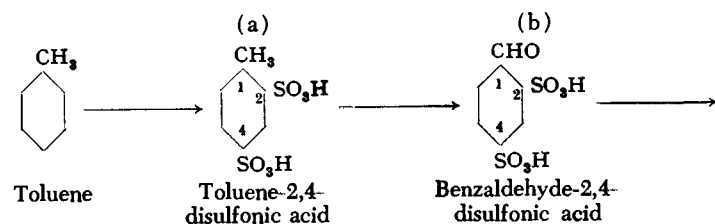
(a) *Toluenedisulfonic Acid*

To 46 grams (0.5 mole) of pure, boiling toluene is added, over a period of 15 minutes, 80 grams of 100 per cent sulfuric acid, and the mixture is heated at 125°C. for 1 hour. During this time the toluene disappears completely. The mixture is cooled to 30°, and 220 grams of 66 per cent oleum is added with thorough stirring over a period of 30 minutes. The solution is then heated for 4 hours at 125°, converting all of the toluene to the disulfonic acid. The mixture is diluted with 400

grams of sulfuric acid (66° Bé) and transferred to a porcelain beaker set up with an efficient iron stirrer.

(b) *Benzaldehydedisulfonic Acid*

To the acid mixture from (a) is added, in small portions, 125 grams of 80 per cent Weldon mud.* The additions are made over a period of 2 to 3 hours at a temperature of about 25°C. When the additions are completed, the mixture is stirred for 3 hours at 30°, and then is heated slowly to 120°. At this temperature, the mixture usually becomes so thick that it can no longer be stirred. The dark color of the manganese dioxide gradually gives way to a light gray, but it is rarely possible, in the laboratory, to carry the reaction to the point where the dioxide completely disappears. After 12 hours, the mass is diluted with 2 liters water and treated with enough slaked lime to neutralize the mineral acid. The solution should not be made strongly alkaline to litmus, however, because excess alkali destroys the benzaldehydedisulfonic acid. The calcium sulfate paste is treated with concentrated soda solution in an amount such that a filtered test portion gives no precipitate on the addition of more soda. The solids are now filtered off and washed well, and, if possible, resuspended in water and refiltered. The weakly alkaline, clear solution is evaporated to 250 cc. under reduced pressure with the introduction of CO₂, and filtered again, if necessary, to remove any residual calcium sulfate and manganese oxides. The yield can be determined by treating a measured test sample, in the presence of sodium acetate, with an acetic acid solution of phenylhydrazine of known strength. The endpoint is reached when no more yellow coloration is formed on adding more of the reagent to a salted-out portion of the test sample. The determination is not very accurate.

(c) *Condensation to the Leuco Dye*

The solution from (b) is mixed with 45 grams of sulfuric acid (66° Bé) and 100 grams of diethylaniline, and boiled under reflux for 2 days. The mixture is then made strongly alkaline by the addition of about 100 grams of 30 per cent sodium hydroxide solution, and the excess diethylaniline is driven off with steam. The alkaline residue is filtered if necessary and made distinctly acid by adding 50 grams of concentrated sulfuric acid. The inner salt of the leuco compound separates, in the course of 24 hours, in the form of fine white needles. These are filtered off and

* The Weldon mud ("Manganschlam") is calculated as MnO₂, i.e., one uses the equivalent of exactly 100 grams of manganese dioxide. Weldon mud, a by-product of saccharin manufacture, has the approximate composition, Mn₃O₄.

washed thoroughly with water. After drying at 80°C., the material weighs about 70 grams.

(d) *Oxidation to the Dye*

This oxidation resembles closely that for malachite green. 50 grams of the leuco compound is dissolved in hot water containing 8 grams of soda ash, the material being quite insoluble in cold soda solution. The solution, which should be exactly neutral to litmus, is made up to 1000 cc. and cooled to 0°C., and to it is added, in one portion with vigorous stirring, a mixture of 15 grams of concentrated sulfuric acid and a paste containing 22 grams of lead peroxide (see page 138). The mixture is held at 0–5° for 1 hour and is then heated to 80° and filtered to remove the lead sulfate. The filtrate is evaporated to 600 cc., preferably *in vacuo*, and 50 grams of salt is added. In the course of a day, the dye crystallizes out and is filtered off and washed with a small amount of saturated salt solution. The dye is dried in a small porcelain dish after adding a few drops of concentrated ammonia to neutralize traces of mineral acid. The yield of dye is about 32 grams.

If the volume of the filtrate after removing the lead sulfate is not greater than 1 liter, the dye can be salted out directly, without previously evaporating the solution, by adding 20 parts of salt. (Salting out should be tried first in a test tube.)

In the presence of acid, the solution of the dye is green; in this case, enough soda is added to change the color to blue before the salting out operation.

Technical Observations. Benzaldehydesulfonic acid is so soluble that it cannot be isolated. The oxidation is carried out in large steam jacketed kneading vessels which are sufficiently strong in construction to permit continuous stirring throughout the reaction. Also, the operation can be done with less sulfuric acid as a diluent. The liming and steaming are carried out by standard methods, except that some difficulties are encountered in that the heating pipes rapidly become encrusted with calcium sulfate. It is not possible to add enough soda to precipitate the calcium completely because of the sensitivity of the aldehydesulfonic acid. The condensation reaction is carried out in leaded kettles and the oxidation in wooden vats equipped with propeller stirrers made from ash wood. The dye solution is evaporated *in vacuo*, and the dye is always removed by centrifuging. The mother liquor is treated with aniline to precipitate a second crop of dye which is less pure and sold as second quality.

More recently, benzaldehydesulfonic acid has been prepared, not from toluene, but from toluenesulfonyl chloride. This use, as well as others, has considerably increased the price of the previously almost worthless *p*-toluenesulfonyl chloride.

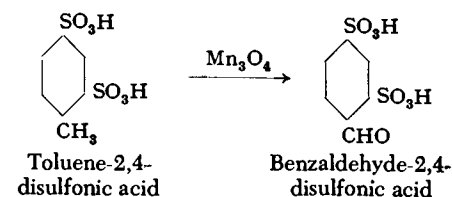
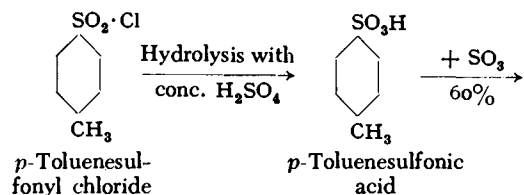

The toluenesulfonyl chloride can first be sulfonated instead of hydrolyzed. The hydrolysis then takes place with the formation of chlorosulfonic acid, and when water is added after the sulfonation, hydrochloric acid is generated immediately.

Wool Blue 5B

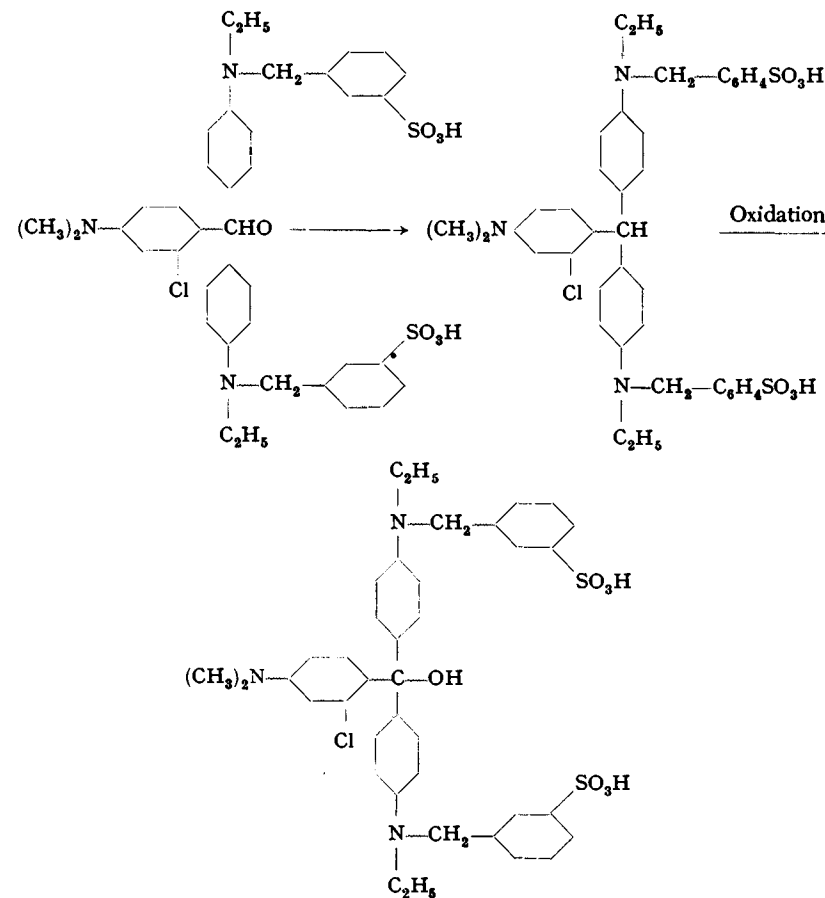

A mixture of 9.2 grams (0.05 mole) of *o*-chloro-*p*-dimethylamino-benzaldehyde (page 119), 32 grams of ethylbenzylaminesulfonic acid,

and 225 grams of 12.5 per cent sulfuric acid is boiled under reflux with stirring for 24 hours. The leuco compound is then precipitated as its sodium salt by careful neutralization with sodium hydroxide. The compound separates as a gummy mass. The mother liquor is decanted, and the residue is dissolved in 500 cc. water. The solution is mixed with an equal volume of saturated salt solution. The leuco compound is precipitated as white flocks which are filtered off, washed with 10 per cent salt solution, and dried *in vacuo* at 100°C. The yield is 36 grams of leuco compound, or 91 per cent of the theoretical amount.

The leuco compound (7.9 grams, 0.01 mole) is dissolved in 100 cc. 50 per cent acetic acid, and to the well stirred solution are added, simultaneously, 30 cc. 10 per cent oxalic acid solution and 12.5 cc. 10 per cent sodium bichromate solution. The mixture turns blue immediately and the oxidation is complete in 10 minutes. The solution is mixed with an equal volume of saturated salt solution and the acetic acid is neutralized with ammonia. The dye precipitates as a reddish, bronzy slime which soon becomes glass-hard. The product is dissolved in hot water, the solution is filtered, and the dye is then salted out by adding an equal volume of saturated salt solution. In this way, 7.8 grams of pure dye is obtained. It gives bright blue tints on wool from neutral or weakly acid solution. The dye is not very fast to light.

Victoria Blue B

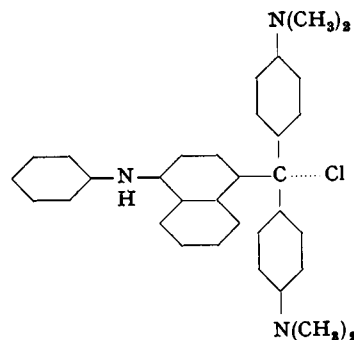

Michler's ketone (page 139) is treated with 25 per cent of its weight of toluene and mixed with an equimolar amount of phenyl- α -naphthylamine (page 179). 1 mole of phosphorous oxychloride is then added, and the mixture is stirred until it becomes thick. The temperature should rise to about 75–80°C. After about 45 minutes, the mass becomes so thick that it can no longer be stirred. It is then mixed with 10 parts

of water, heated to boiling to decompose the phosphoric acid addition product, and treated with enough sodium hydroxide solution to make the mass green and lustrous. The toluene is driven off with steam, and the mother liquor poured off. The dye is dried at 80–90°. The yield is quantitative.

Victoria pure blue BO is prepared in a similar way from the tetraethyl ketone and ethyl- α -naphthylamine.

Wool Green S

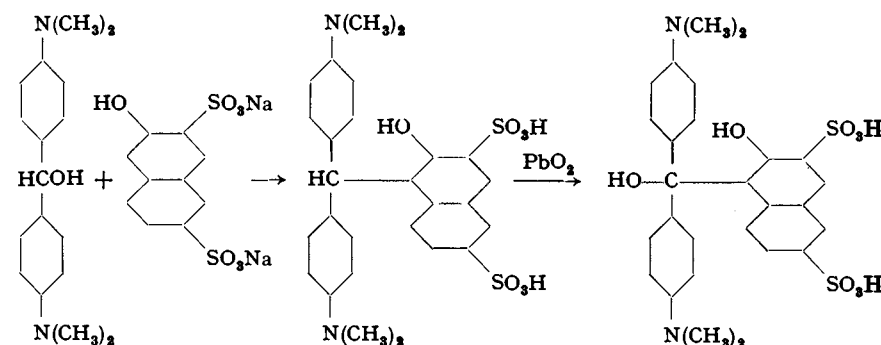

0.05 mole (13.5 grams) of tetramethyl-*p,p'*-diaminobenzohydrol (page 138) is added with stirring to 120 grams of sulfuric acid (66° Bé) at such a rate that the temperature does not rise above 40°C. When the solid has all dissolved, the solution is cooled in an ice bath to about 5°, and the amount of technical R salt corresponding to 21.8 grams (0.0625 mole) of pure sodium 2-naphthol-3,6-disulfonate is added with stirring while the temperature is kept at 5–10°. The mixture is then stirred at room temperature for about 2 hours, then warmed to 60° during the next hour, and held at this temperature for about 2 hours until a test sample, diluted with water and treated with sodium acetate, gives only a weak blue coloration which is not increased by heating. The reaction mixture is then poured into 700 cc. cold water, and crystallization of the condensation product is started by seeding or scratching the walls of the vessel with a glass rod. Stirring is continued for several hours, and the mixture is allowed to stand overnight. The sandy precipitate is filtered off, washed with cold water until the washings are no longer acid to Congo red, then twice with alcohol and twice with ether, and finally dried in a vacuum desiccator. The yield of loose, gray white powder is 24 grams, or about 86 per cent of the theoretical amount.

The leuco compound is dissolved in 480 cc. cold water containing 15 grams of soda ash, and the solution is cooled by addition of 160 grams

of ice. With vigorous stirring, lead dioxide paste, prepared from 14.3 grams of lead nitrate (page 138), is added in one portion. The mixture immediately becomes deep blue. Stirring is continued for 30 minutes at room temperature, and the mixture is then heated to 80°C. over a period of 1 hour, after which the lead carbonate is removed by filtration and washed with hot water. The filtrate is cooled and acidified with 20 cc. concentrated hydrochloric acid,* and 200 grams of salt is added with stirring. The bronzy, crystalline precipitate of the dye is filtered off after standing overnight, washed with salt solution, and dried, preferably at 50–60° *in vacuo*. The product, which contains some salt, weighs about 24 grams.

Wool green S dyes wool from acid baths to give very strong blue green shades. This dye and naphthalene green V, which is prepared in an analogous manner from tetraethyl-diaminobenzohydrol and 2,7-naphthalenedisulfonic acid, are among the most widely used green wool dyes.

F. OXAZINE AND THIAZINE DYES

Gallamine Blue from Gallamide

Nitrosodialkylanilines react with gallic acid or gallamide under the influence of heat to form well defined compounds designated as oxazines. The gallic acid is obtained exclusively from natural tannins.

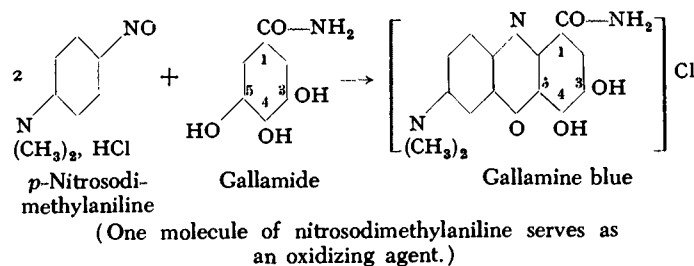

(a) Nitrosodimethylaniline

A mixture of 100 grams of dimethylaniline and 200 grams of 30 per cent hydrochloric acid is cooled, and 300 grams of ice is added. The

* At this point, the solution should not change color from blue to green; if it does, too much acid has been added. Excess acid prevents complete precipitation of the dye and should be neutralized by the addition of sodium acetate.

beaker containing the mixture is placed in an ice bath, and a solution of 60 grams of 100 per cent sodium nitrite in the least possible amount of water is added dropwise over a period of 5 hours. The presence of free nitrous acid in the reaction mixture cannot be tested for by starch-iodide paper, since nitrosodimethylaniline itself gives a positive test. Excess nitrous acid, therefore, must be detected solely by smell. The mixture should have an acid reaction to Congo red, of course. After 6 hours, the mixture is filtered, and the precipitate, rinsed into the funnel by some of the mother liquor, is sucked as dry as possible, pressed out in a screw press, and then pulverized. The resulting nitrosodimethylaniline hydrochloride should not be dried, but used while still moist. In large scale operations, the product is dried sufficiently merely by centrifuging.

p-Nitrosodiethylaniline is prepared in a similar way, except that no water is added to the nitrosation mixture because of the very high solubility of the hydrochloride. Concentrated hydrochloric acid and saturated sodium nitrite solution are used. Industrial preparations are carried out in enameled equipment such as is used in tropaeoline coupling.

(b) Gallamine Blue

In a glass vessel equipped with reflux condenser and stirrer (Fig. 6), a solution of 20 grams of gallamide (page 170) of about 92 per cent purity (the purity is determined by distilling off the ammonia from a sodium hydroxide solution and titrating) in 500 cc. 90 per cent alcohol is heated to boiling, and the nitrosodimethylaniline hydrochloride, prepared from 75 grams of dimethylaniline, is added in three portions, allowing a 15-minute interval between additions. The mixture is then refluxed for 4 hours and allowed to stand for 12 hours more. The gallamine blue comes out as a lustrous, bronzy precipitate which is filtered off and washed with water. The alcohol is recovered and rectified. The yield of pure gallamine blue is about 40 grams. The alcoholic mother liquor yields a gray, nigrosine-like dye which gives very fast gray tints on cotton (with chromium acetate); this dye is called methylene gray.

Gallamine blue, which is quite insoluble in water and hence cannot be used as such, can be converted to soluble forms in various ways.

One part of gallamine blue is heated to 50°C. on a water bath with 6 parts of sodium bisulfite solution (25 per cent SO₂) until the evolution of sulfur dioxide ceases (about 1 hour). The mixture is then heated for 1 to 3 days at 85° until the mixture has become gray green. The resulting product is the sulfonic acid of the leuco compound (perhaps complex sulfonate) which, with chromium acetate, gives brilliant and fast marine blue shades on wool. It can also be used in cotton printing, but is not as important for this use as the related dye, modern violet.

Reduction of gallamine blue with hydrogen sulfide produces a leuco compound, modern violet, which gives extremely pure and fast chromium lakes on cotton.

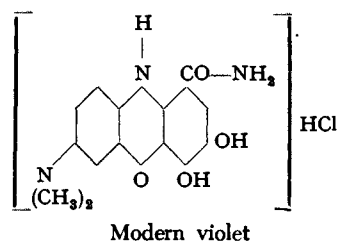

To the clear solution of 50 grams of gallamine blue in about 40 grams of 30 per cent sodium hydroxide and 400 cc. water, 50 grams of crystalline sodium sulfide is added. During the course of 1 hour at 60°C., the mixture is slowly acidified by the addition of about 100 grams of concentrated hydrochloric acid until a permanent acid reaction to Congo red is produced. The blue color almost disappears, and the nearly colorless solution is filtered to remove sulfur. The filtrate is treated with 150 grams of salt to precipitate the leuco compound which is filtered off, washed with a small amount of saturated salt solution, and pressed out well. The product should be dried *in vacuo* at 60° since it is easily re-oxidized. The yield is about 55 grams.

Technical Observations. Industrial preparations are carried out in enameled iron vessels with lead-tube reflux condensers. The preparation starting with 40 kilograms of gallamide requires about 12 hours.

Modern violet must be powdered in the cold because its high oxidizability may cause spontaneous ignition. This may be caused, in some cases, by the presence of finely divided sulfur.

The oxazines are excellent printing colors. In addition to dimethylaniline derivatives, those from diethylaniline are also prepared. The latter give very pure greenish tints. If gallic acid is used in place of gallamide, gallocyanine is formed. This dye was first discovered by H. Köchlin, who, in trying to fix nitrosodimethylaniline to cotton by means of tannin and tartar emetic, obtained blue dyes which he recognized as oxazines. Gallocyanine cannot be prepared satisfactorily in ethyl alcohol solution. Methyl alcohol gives better results, but is an undesirable solvent because of its toxicity and volatility. Many more complicated oxazines are known but these cannot be described here.

It should be mentioned in passing that the first oxazine to attain technical importance was Meldola blue (naphthol blue, Bengal blue), prepared from nitrosodimethylaniline hydrochloride and β -naphthol. It is a very fast dye but does not give pure shades. Furthermore, its dust irritates the mucuous membranes so severely that many persons cannot work with it. Despite these disadvantages, however, Meldola blue is still rather widely used.

Methylene Blue from Dimethylaniline

The formation of methylene blue is interesting both scientifically and technically, and should be reviewed briefly before the actual procedure is described.

(a) Nitrosodimethylaniline is prepared from dimethylaniline by treatment with nitrite in acid solution. The nitroso compound is then reduced to form *p*-aminodimethylaniline.

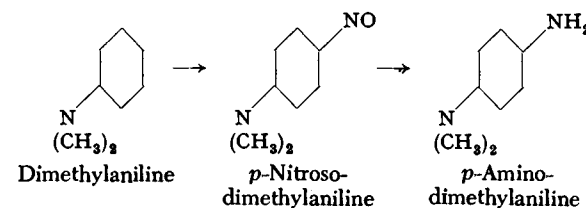

(b) The *p*-aminodimethylaniline is oxidized in acid solution with another molecule of dimethylaniline, and simultaneously a thiosulfonic acid group is introduced. This step is accomplished by oxidizing in the presence of thiosulfuric acid *in statu nascendi*.

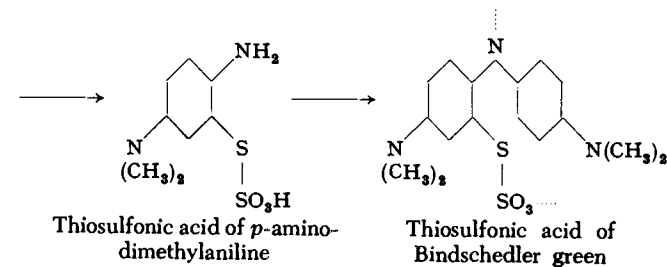

(c) The thiosulfonic acid is then oxidized further and undergoes ring closure to form methylene blue.

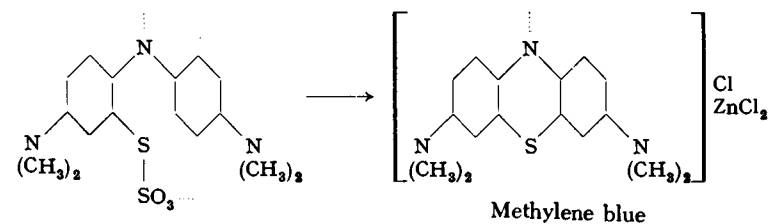

(a) *p*-Aminodimethylaniline

A cooled solution of 24.2 grams (0.2 mole) of pure dimethylaniline in 75 grams of 30 per cent hydrochloric acid is mixed with 150 grams of ice,

and a 20 per cent solution containing 14.7 grams of sodium nitrite is added over a period of 1 hour. Nitrosation is complete in 4 hours. To the solution are added 110 grams of 30 per cent hydrochloric acid and 200 grams of ice, and then, over a 15-minute period with thorough mechanical stirring, 35 grams of high quality zinc dust. The temperature may rise to 25°C. without causing damage. The solution, which becomes colorless and neutral, is filtered and the residue of zinc dust is washed with a small amount of water.

(b) Thiosulfonic Acid of Bindschedler Green

This oxidation must be carried out in the presence of a zinc chloride solution which has no reducing action. A suitable solution can be prepared by dissolving sheet zinc in concentrated hydrochloric acid. (In the industry, the technical zinc chloride liquor is treated with enough sodium bichromate to destroy the reducing action. Frequently, this requires 100 to 250 grams of bichromate for 100 kilograms of the liquor.) The thiosulfuric acid is supplied by aluminum thiosulfate which is so highly dissociated that it reacts as free thiosulfuric acid.

Before the preparation of methylene blue is started, solutions of the necessary reagents are prepared so that the materials can be added rapidly and at the correct temperature.

Solution I. 38 grams of pure aluminum sulfate in 60 cc. water.

Solution II. 52.5 grams of crystalline sodium thiosulfate in 50 cc. water.

Solution III. 57 grams of sodium bichromate in 90 cc. solution.

Solution IV. 20 grams of dimethylaniline in 27 grams of concentrated hydrochloric acid.

Solution V. 25 grams of very finely ground manganese dioxide slurred with 30 cc. water.

The clear, neutral solution of *p*-aminodimethylaniline is made acid by the addition of 4 grams of concentrated sulfuric acid, and 100 grams of a 50 per cent, nonreducing solution of zinc chloride is added.

The beaker is placed on a felt pad, and a tube is arranged for blowing in steam. With thorough stirring, Solution I is added at room temperature, followed by Solution II, and 2 seconds later by one-third of Solution III (equivalent to 19 grams of sodium bichromate). The temperature of the mixture is raised to 40°C. in the course of 1 minute by the introduction of dry steam, and then Solution IV is added followed by the remainder of Solution III. The mixture is then heated rapidly to 70°. The solution becomes dark greenish blue in color due to the formation of the thiosulfonic acid of Bindschedler green. When the temperature reaches 70°, the slurry (V) is added and the temperature is raised to 85°.

The manganese dioxide is added to convert the sulfurous acid formed in the ring closure reaction to dithionate which is harmless. Equally good results can be obtained by using 40 grams of copper sulfate which is converted in the reaction to insoluble Cu_2O .

The solution at 85° has a lustrous bronzy appearance as the dye precipitates from the concentrated zinc chloride solution. After 30 minutes, the mixture is allowed to cool to 50°C., and 70 grams of concentrated sulfuric acid is added to dissolve the manganese salts, aluminum hydroxide, and chromium oxide. The dye is filtered off at 20° and washed with a small volume of 10 per cent salt solution. This crude product is dissolved in 1 liter water at 100°, the solution is filtered, and the dye is reprecipitated by the addition of 50 grams of ordinary 50 per cent zinc chloride solution and 150 grams of salt. The zinc chloride double salt of the dye separates completely in 24 hours in the form of beautiful bronzy red crystals which are filtered off, washed with 10 per cent salt solution, and dried at 50° (no higher). The yield of pure, concentrated dye is about 44 grams.

The method described above was worked out by Bernthsen and Ulrich, who also recommended the use of aluminum thiosulfate. The practice of adding manganese dioxide or copper sulfate is generally followed. Relatively small quantities of dye are prepared in one run because rapid heating is important. The final dye is filtered off, using filters such as the one shown in Figure 27, page 151, and then placed in small bags and centrifuged.

Methylene blue is highly valued because it gives pure shades and is inexpensive. It is widely used for coloring tanned cotton. The zinc-free dye is used for discharging on silk. To produce the zinc-free dye, ordinary methylene blue is dissolved in water, and the zinc is precipitated by adding soda, leaving the easily soluble dye base in solution. The base is then precipitated from the filtered solution by adding salt. In large scale preparations, the crystallization requires several days, and is promoted by cooling, using lead pipes through which cold water is circulated.

Methylene green, the nitro derivative of methylene blue, is an interesting dye. The nitration is effected in the same way as that of tropaeoline, using the crude zinc chloride double salt without further treatment.

The moist, crude methylene blue, as obtained in the above preparation, is mixed with 50 cc. water and 20 grams of 62 per cent nitric acid (40° Bé); and 5 grams of sodium nitrite, dissolved in the minimum amount of water, is added at 25°C. The temperature is then raised to 50° with continuous stirring, and held at this point for 2 hours. The mixture is then diluted with 200 grams of saturated salt solution and filtered after 12 hours. The crude dye is redissolved in 1 liter water at 60° (not higher), the solution is filtered, and the dye is reprecipitated by the addition of 150 grams of salt and 50 grams of 50 per cent zinc chloride

solution. The product is filtered off after 12 hours and dried at 45° until it can just be powdered. At this point, the dye still contains about 20 per cent of water, but it cannot be dried further without causing the color strength to decrease and part of the product to become insoluble. The yield is about 38 grams of concentrated material.

Methylene blue and methylene green are diluted with dextrin since the use of salts greatly decreases their solubility. Methylene green is used chiefly for producing black shades on silk, in combination with logwood-iron mordants and also with tin phosphate. The shades produced in this way are the most brilliant and fast blacks for silks.

When diethylaniline is used in place of dimethylaniline, the pure greenish thiazine blue is formed. (Monoethyl-*o*-toluidine gives thionine blue.) Thiazine blue gives very pure blue shades on silk, but its importance is reduced by the availability of more fast alizarin dyes. The nonalkylated methylene blue, diaminophenazthionium chloride or Lauth violet, is used in moderate amounts for producing pure violet shades. It is still prepared by the old method involving simultaneous oxidation of *p*-phenylenediamine and hydrogen sulfide with iron chloride.

G. ANTHRAQUINONE DYES

(a) Mordant Dyes

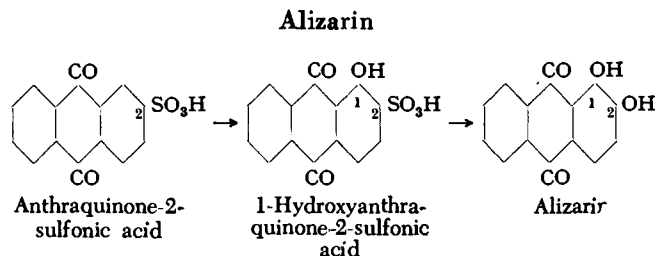

Alizarin (1,2-dihydroxyanthraquinone) is formed by alkali fusion of sodium anthraquinone-2-sulfonate ("silver salt"). The reaction is rather remarkable in that not only is the sulfo group replaced by hydroxyl, but a second hydroxyl is also introduced. The presence of an oxidizing agent has a favorable effect on the reaction.

The alizarin fusion was first undertaken industrially by Caro. In the earlier days, saltpeter was used as the oxidizing agent but this was replaced some seventy years ago by chlorate, following the suggestion of Koch, and today most processes still employ electrolytic sodium chlorate, which is cheap.

A mixture containing the equivalent of 100 grams of 100 per cent

"silver salt" (page 228), 260 grams of 100 per cent sodium hydroxide, 28 grams of sodium chlorate, and enough water to make a total volume of 670 cc. is heated at 185°C. with continuous stirring in an autoclave. The pressure increases to 5 or 6 atmospheres. After 48 hours, the apparatus is cooled, and a test is made to determine whether the fusion is completed. To this end, 2 cc. of the melt is removed, the alizarin is precipitated with the necessary amount of concentrated hydrochloric acid, and the filtrate is extracted twice with ether. The solution, thus freed

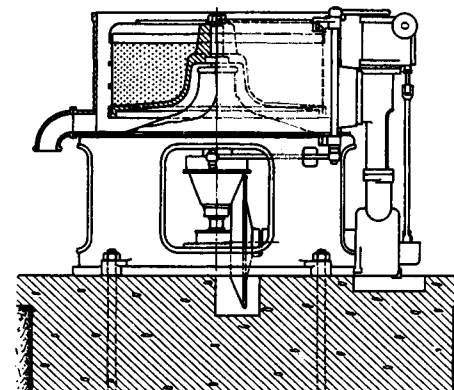

Fig. 33. Centrifuge with bottom discharge.

from alizarin, is diluted to 15 cc. and examined for fluorescence caused by unchanged silver salt or monohydroxyanthraquinonesulfonic acid. Only a very weak, if any, fluorescence should be visible. If necessary, the mixture is heated for an additional 24 hours at 190°. The melt is then diluted with 2 liters water, the mixture is heated to boiling, and the alizarin is precipitated with 50 per cent sulfuric acid. The dye is filtered off at 50° and washed until the washings are free from salts. The alizarin is not dried since then it does not dye well. The yield is determined by drying a test sample. Usually, the dye is made up to a 20 per cent preparation. About 70 grams of pure alizarin is obtained from 100 grams of pure silver salt.

Technical Observations: Alizarin was the first naturally occurring coloring matter which was successfully prepared synthetically on a commercial scale. This synthesis was a triumph for the then young coal-tar dye industry, and for a long time alizarin was its most important product. The world production of alizarin (as 100 per cent material) was about 2,800,000 kilograms yearly, of which the Badische A.S.F. supplied 2,000,000 kilograms. In more recent times, the consumption of alizarin has been greatly reduced as a result of the competition of more easily applied red dyes of the azo series, especially some of the equally fast naphthol AS combinations.

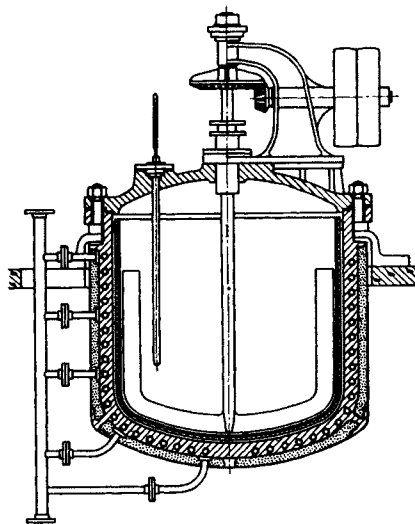
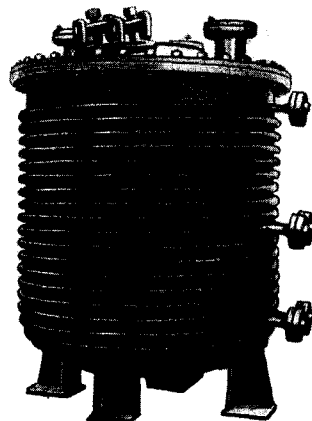

Fig. 34. Kettle heated with steam or hot water (Frederking).



(a)



(b)

Fig. 35. Reaction kettle (Samesreuther). The kettle is equipped with external heating or cooling coils. The coils are mounted on copper supports (b) which conduct heat to or from the kettle. This heating system is quite different from that used in the Frederking apparatus (Fig. 34). If the kettle wears out, the heating system can be used for a new kettle. These kettles are very useful, e.g., for sulfonations in which varying heating and cooling must be used (see p. 211, H acid).

Alizarin fusions are carried out in Frederking apparatus, such as shown in Figure 34, or in similar kettles of the Samesreuther type (Fig. 35a and b). Since the chlorate-containing melt* attacks the apparatus, the equipment is always made with an insert of alkali-resistant cast iron which can be replaced easily. There are many variations in these apparatus. The industrial preparations are run in very large batches; in some cases 2000 to 2500 kilograms of 100 per cent alizarin is made at one time in one reaction kettle. The product is made up into either a 20 per cent or a 16 per cent paste. The material is standardized by determining the dry weight and by test dyeing. In plant operations, it is possible to use much less sodium hydroxide, only 110 per cent of the theoretical amount (in our example, only about 40 grams instead of 260 grams). Alizarin, once dried, can easily be regenerated by dissolving it in borax and reprecipitating with acetic or sulfuric acid. Dyes of the alizarin type must be precipitated from boiling solution because of their low solubility. Only in this way can a finely divided product be obtained. A solid preparation of alizarin is prepared for the Orient by mixing the dye with enough starch to make dry lumps which, when placed in boiling water, form a paste suitable for dyeing.

(b) Acid Dyes

Quinizarin Green or Alizarin Cyanine Green G

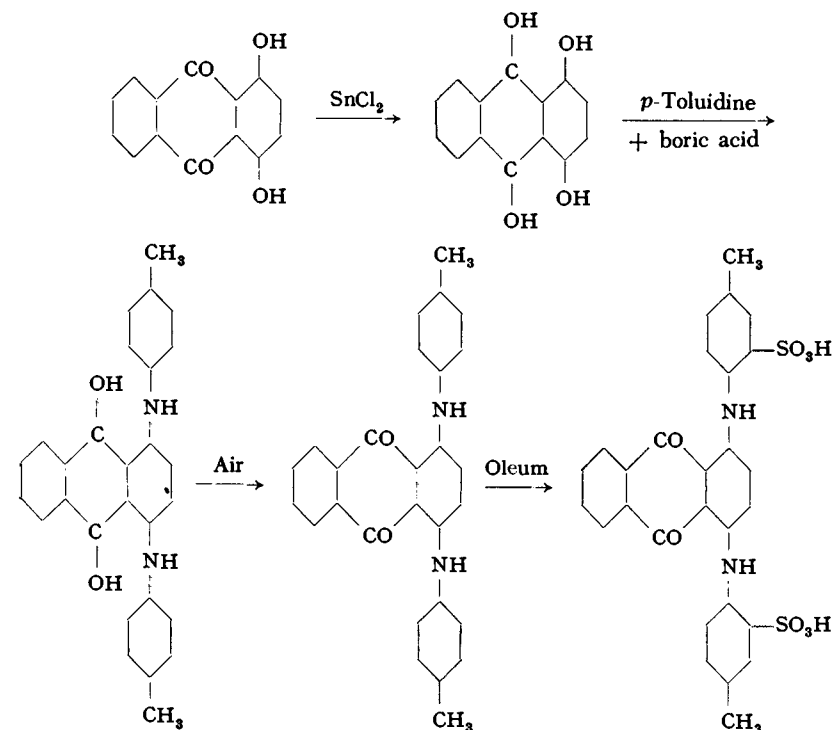

* In many plants, saltpeter is preferred over chlorate since it attacks iron less readily and is reduced directly to ammonia in the process. Chlorate, however, gives a more clear-cut reaction.

In a 1.5- to 2-liter round-bottomed flask fitted with a downward condenser, stirrer, and thermometer, a mixture of 500 grams of *p*-toluidine and 60 grams (0.25 mole) of quinizarin (page 237) is heated to 80°C., and to it is added, with stirring, a mixture of 18 grams of boric acid, 30 grams of stannous chloride, and 16 grams of chalk. The mixture is held at 110° for 1 hour, then at 120° for 1 hour, and finally at 130° for 2 hours. During the heating, the water formed in the reaction distills off along with some *p*-toluidine. The reaction mixture, after cooling to 70°, is diluted with 350 cc. alcohol, cooled thoroughly, and transferred to a stoppered container, rinsing the flask and stirrer with an additional 350 cc. alcohol. After standing overnight, the precipitated material is filtered off, stirred with 2 successive 300-cc. portions of alcohol, and finally washed on the filter with alcohol until the washings are nearly colorless.

The resulting crude base is purified by boiling it with a mixture of 70 cc. concentrated hydrochloric acid and 1600 cc. water, filtering hot, and washing the solid with hot water until it is neutral. The residue is then boiled with a mixture of 1600 cc. water and 40 cc. 40° Bé sodium hydroxide solution, and again washed until neutral. The quinizarin green base, after drying, weighs 85 to 90 grams.

Sulfonation is carried out by adding 25 grams of the base to 250 grams of 10 per cent oleum with stirring. The temperature is allowed to rise to 40–45°C. and is held at this point for 2 to 3 hours in order to get rapid solution. The mixture is then allowed to stand for 24 hours and is then poured into 1 liter water, washing out the flask and stirrer with an additional 1 liter water. The diluted acid solution, which should be at about 50–60°, is treated with 250 grams of salt. On cooling, the dye separates out in an easily filterable, crystalline form. It is filtered off and pressed out, and then redissolved in about 1500 cc. hot water. The solution is neutralized with 15 grams of soda ash and filtered through a fluted filter, washing the residue with hot water. 500 grams of salt is added to the hot filtrate, and the dye, after it has precipitated completely, is filtered off, pressed out, and dried. The yield is about 50 grams.

Alizarin Saphirol B and SE

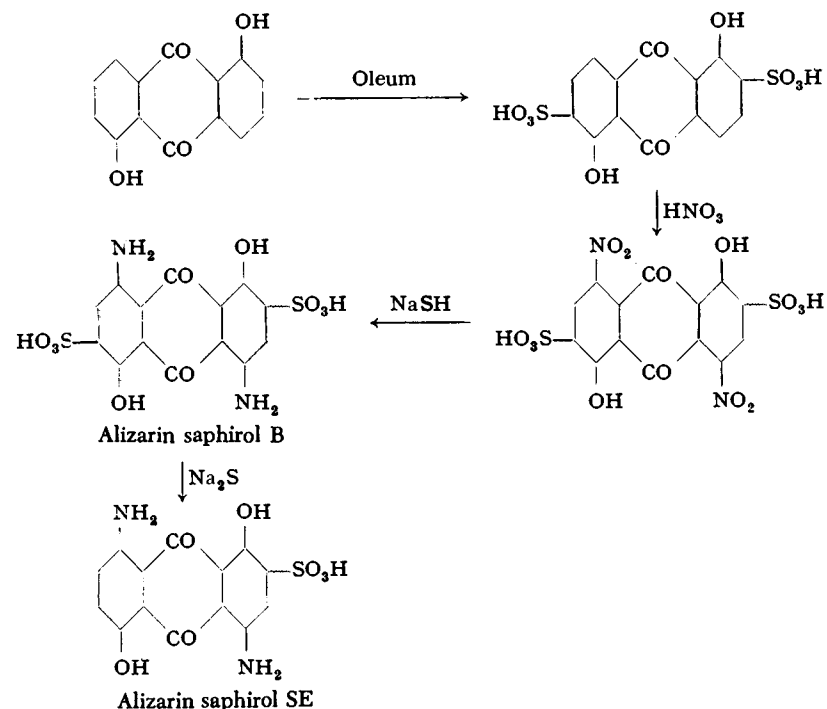

Sulfonation and Nitration. To 188 grams of 20 per cent oleum is added, with stirring at room temperature, 50 grams of thoroughly dried, finely pulverized 1,5-dihydroxyanthraquinone or its mixture with the 1,8 isomer (see page 236). The temperature is raised slowly to 100°C. during the course of 1 hour and held at this point for 2 hours more, then raised to 105° for 2 hours, and finally held at 110° until a test sample gives a clear solution in cold water. The mixture is then cooled to 25–30°, and 272 grams of 100 per cent sulfuric acid is added, followed by the dropwise addition, over a period of 1 hour, of a mixture of 36 grams of nitric acid (48° Bé) and 109 grams of 20 per cent oleum. (This mixture must be prepared very carefully, adding the oleum *slowly with stirring* to the *well cooled* nitric acid.) During the addition of the nitrating mixture, the reaction mixture is cooled in water so that the temperature does not exceed 30°C. When the addition is complete, the temperature is raised slowly to 35°, held at this point for 2 hours, then raised to 55° for 2 hours, and finally to 80° for 2 hours. The mixture is then cooled to 30° and poured, as rapidly as the foaming will permit, into

200 cc. cold water. The temperature rises to 110–115°. The resulting mixture, which is about 75 per cent sulfuric acid, is cooled and filtered, after 2 days' standing, through a sintered glass funnel (or through asbestos) and sucked as dry as possible. The filter cake is then dissolved in about 1 liter water, and the solution is filtered to remove any undissolved residue. The filtrate should be perfectly clear and remain so on standing.

Reduction. The nitro compound is reduced by means of a concentrated solution of sodium hydrosulfide, NaSH, the preparation of which was described on page 113. A test is made in the following way to determine how much of the reducing agent is required: 25 cc. of the filtered solution of the nitro compound is pipetted into a 750-cc. Erlenmeyer flask, diluted with 350 cc. hot water, and neutralized with soda to the point where the red coloration, which is formed, just persists. A sodium hydrosulfide solution, prepared by diluting 10 cc. of the concentrated solution to 100 cc., is then added, at 60–70°, from a burette until the color of the solution turns to a pure blue. Additional 1-cc. portions of the hydrosulfide solution are added until a definite blackening is obtained when the colorless spot on filter paper, formed by a salted-out test sample, is treated with ferrous sulfate. From the amount of hydrosulfide used in the test determination, the amount required for the total volume of the nitro solution is calculated.

The main body of the solution of the nitro compound is then neutralized with soda ash to the point giving a permanent red coloration, and heated to 60–65°C. The calculated amount of concentrated hydrosulfide solution is added slowly with stirring, and the mixture is held at 60–65° for 3 hours. Enough salt is then added to make the solution 10 per cent with respect to salt, and the solution is cooled with stirring. The precipitated dye is filtered off, washed with 15 per cent salt solution until the washings are colorless, pressed out, and dried at 90°. The yield of alizarin saphirol B is about 105 grams.

Splitting Out of One Sulfo Group. 25 grams of alizarin saphirol B is mixed with 800 cc. hot water, 46 grams of 40° Bé sodium hydroxide solution is added at 90°C., and the mixture is heated until all of the material has dissolved. A solution of 10 grams of sodium sulfide in 50 cc. water is then added slowly and the mixture is held at 95–100° with stirring, keeping the volume at about 1 liter, until a diluted test sample, when acidified with sulfuric acid, gives a filtrate which is wine red instead of blue. When this point is reached, 200 grams of salt is added immediately, and the solution is cooled with stirring. When a tempera-

ture of 30–40° is reached, the precipitated dye is filtered off, washed with 10 per cent salt solution, pressed out, and dried. The yield of alizarin saphirol SE is 22 to 24 grams.

Technical Observations: The dyes, prepared from 1,5- and 1,8-dihydroxyanthraquinone by the above procedure, are so similar that frequently a mixture of the two is used. The SE dye can be prepared without isolating the intermediate disulfo dye (alizarin saphirol B), the reduced solution from the hydrosulfide reduction being treated directly with sodium sulfide.

(c) Vat Dyes

Indanthrene Blue RS from β -Aminoanthraquinone

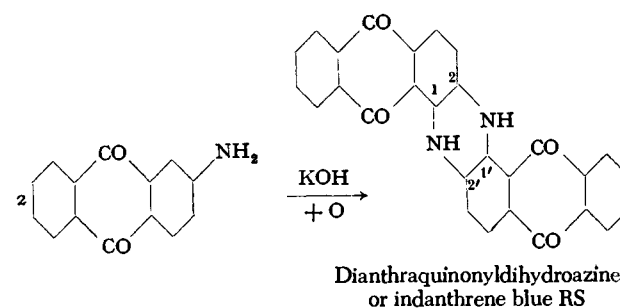

An intimate mixture of 50 grams of pure β -aminoanthraquinone (page 229), 25 grams of potassium acetate, and 6 grams of potassium nitrate is added in small portions to a melt of 150 grams of potassium hydroxide and 20 cc. water, heated to 210°C. A crucible made of nickel or V2A steel should be used as the reaction vessel, and the stirrer should be made of the same material. Iron is not suitable for the purpose. The additions are completed in 20 minutes, and the mixture is heated for 5 minutes more at 215–220° (not higher) with thorough stirring. The melt is then poured onto 1 kilogram of ice, washing out the residue from the reaction vessel with a small amount of water. The entire melt is dissolved in the water, and 40 grams of concentrated sulfuric acid is added to salt out the dye. The solution, which is still alkaline, is then heated to 60° and treated with 30 grams of sodium hydrosulfite. The blue leuco derivative of indanthrene blue RS which is formed is insoluble in the salt solution. When the mixture is cold, the leuco compound is filtered off, using a cotton filter on a suction funnel. The product is washed with a 2 per cent sodium hydroxide solution containing 5 grams of sodium hydrosulfite per liter until the washings are clear and light blue in color. The precipitate is then stirred with 500 cc. water

(b) Indoxylcarboxylic Acid

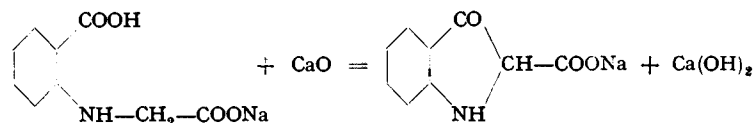

A mixture of 25 grams of sodium hydroxide (completely dehydrated by fusing in an iron crucible), 25 grams of potassium hydroxide (similarly dehydrated), 7.5 grams of caustic lime (dehydrated by igniting without sintering in a porcelain crucible), and 25 grams of thoroughly dried monosodium phenylglycine-*o*-carboxylate is ground in a ball mill with exclusion of moisture. The resulting intimate mixture is heated in a vacuum baking apparatus (Fig. 30, page 181) in a graphite bath for 2 hours at 150°C., then for 6 hours at 230–235°. A homogeneous, yellow brown, hard mass is formed.

(c) Indigo

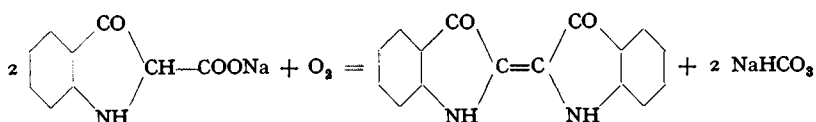

The fusion mixture from (b) is dissolved in 2 liters water at 80°C., and a vigorous stream of air is passed through the solution until no more indigo is formed in a filtered test sample when shaken with air. The precipitated dye is filtered off, washed with water, boiled with dilute hydrochloric acid to remove all of the lime, filtered again, washed thoroughly with water, and finally dried in a steam heated oven. The yield is 12 to 12.5 grams, or 80 to 82 per cent of the theoretical amount based on the phenylglycine-*o*-carboxylic acid.

The foregoing procedure, discovered by Heumann and worked out by the Badische A.S.F., was the first process used on a large scale for the preparation of indigo. It was kept in operation for a long time, along with the related process (Deutsche Gold- und Silberscheideanstalt) employing potassium and sodium hydroxides in combination with sodium amide, and only recently has it been replaced by other processes.

2. Traugott Sandmeyer Synthesis¹⁰⁰

Although the Sandmeyer indigo synthesis is no longer used, it is such an interesting example of the combined efforts of science and in-

¹⁰⁰ Sandmeyer, *Z. Farben- u. Textilchem.*, No. 7, p. 129 (1903). Also, *Helv. Chim. Acta*, 2, 234 (1919).

dustry that it deserves a place in this book. The process involves the following steps:

(a) Aniline is converted to thiocarbanilide (A. W. Hoffmann) by heating with carbon bisulfide:

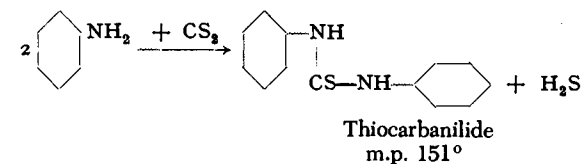

(b) Sulfur is split from the thiocarbanilide by treatment with basic lead carbonate, and simultaneously hydrocyanic acid is added, resulting in the formation of Laubenheimer's hydrocyanocarbodiphenylimide:

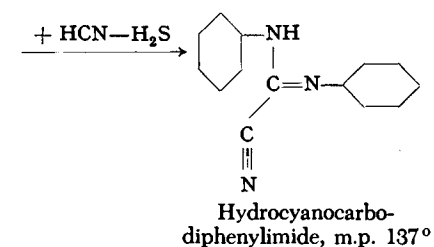

(c) The hydrocyanocarbodiphenylimide is converted to thiooxamidodiphenylamide ("thioamide") by treatment with yellow ammonium sulfide:

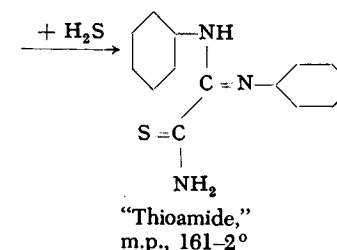

(d) The "thioamide" is converted smoothly to α -isatinanilide by the action of concentrated sulfuric acid:

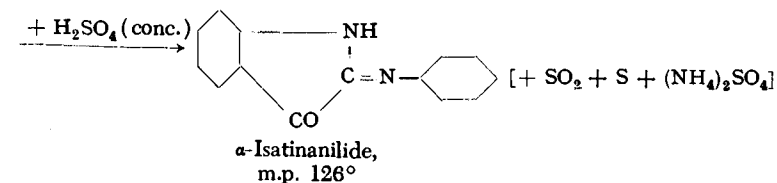

(e) The α -isatinanilide can be converted to indigo in various ways. It can be reduced in alcoholic solution with dilute ammonium sulfide solution, or converted to α -thioisatin which immediately goes to indigo when treated with alkali. The latter method is shown here because it was used industrially:

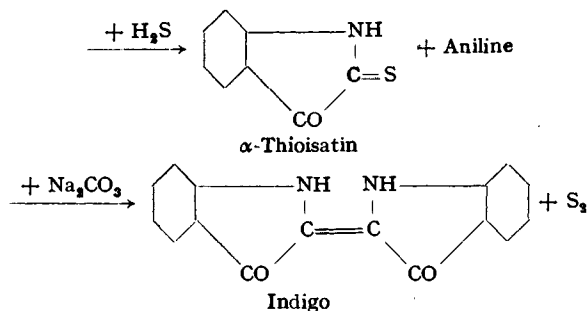

(a) Thiocarbanilide

A mixture of 186 grams of pure aniline and 100 grams of pure carbon bisulfide is boiled under reflux until evolution of hydrogen sulfide ceases, which requires about 2 days. The temperature of the oil bath is then raised to 160°C. and the excess carbon bisulfide is distilled off. The residue of melted thiocarbanilide is poured out into a flat dish and pulverized after cooling. It is desirable to recrystallize the crude product from alcohol which gives lustrous crystals melting at 151°. The yield is about 200 grams of purified material. (Recrystallization of the thiocarbanilide is usually omitted in industrial preparations, although such purification would prevent the formation of small amounts of oily by-products in subsequent steps.)

(b) Hydrocyanocarbodiphenylimide

A solution of 350 grams of lead nitrate in 1 liter hot water is treated carefully at 95°C. with about 120 grams of soda ash and the precipitated basic lead carbonate is washed thoroughly with water. The moist material is transferred to a 2-liter flask fitted with stirrer and reflux condenser (Fig. 6) and mixed to a homogeneous paste with 600 grams of 90 per cent alcohol. One mole (228 grams) of very finely pulverized thiocarbanilide is added rapidly, followed by the addition, at 25°, of 1.3 moles of sodium cyanide (about 60 grams of technical material).*

* The HCN content of the sodium cyanide must be determined!

With vigorous stirring, the temperature is raised to 77°C. during the course of 1 hour, and then a small test portion is removed and filtered. The colorless filtrate should not be blackened by the addition of a pinch of basic lead carbonate. If it is, heating is continued for an additional hour, and the test is repeated. If the test is still positive, additional lead carbonate and sodium cyanide are added, but this should not be necessary if the correct amounts of reagents were used originally.

When the reaction is completed, the mixture is heated to boiling and filtered hot, extracting the residue with two 500-cc. portions of alcohol. The hydrocyanocarbodiphenylimide is allowed to crystallize out. The first fraction is entirely pure and weighs about 160 grams. The mother liquor, after concentration, yields an additional fraction of about 40 grams of nearly pure product. The yield is about 98 per cent of the theoretical amount. The hydrocyanocarbodiphenylimide crystallizes in yellowish prisms melting at 137°. The mother liquors contain hydrocyanic acid and must be handled carefully.

(c) "Thioamide"

The addition of hydrogen sulfide to the hydrocyanocarbodiphenylimide takes place very easily if the latter is finely powdered. The material is therefore ground in a roller mill or sifted. 200 grams of the finely divided material is emulsified by vigorous stirring at 35°C. in 500 grams of yellow ammonium sulfide solution. (The reaction can be greatly accelerated by the addition of an equal volume of alcohol.) The ammonium sulfide solution is prepared by passing 35 grams of hydrogen sulfide into a mixture of 460 grams of 20 per cent aqueous ammonia and 25 grams of powdered sulfur. If the hydrocyanocarbodiphenylimide is powdered finely enough, the addition of hydrogen sulfide takes place quantitatively within 12 hours, as shown by the fact that a washed sample is soluble in dilute hydrochloric acid. The product is filtered off and washed thoroughly with water. It is sufficiently pure for use in the next step. The yield is about 220 grams. It crystallizes from alcohol in yellow prisms melting at 162°.

(d) α -Isatinanilide

The ring closure to an isatin derivative takes place only under certain, accurately controlled conditions. It is important that the reaction be carried out in hot sulfuric acid.

In the course of 15 minutes, 200 grams of pure, dry, finely divided "thioamide" is added to 800 grams of 94 per cent sulfuric acid (66° Bé) at a temperature of exactly 94°C. Considerable heat is generated and the mixture must be cooled. When the mixing is complete, the mixture is heated at 106–108° for one hour, after which no more sulfur dioxide is evolved. The solution is then cooled to 20°, and the product is converted to the hydrochloride of α -isatinanilide by pouring it in a thin stream into a well stirred mixture of 1 liter water, 2 kilograms of ice, and 500 grams of salt. The hydrochloride of α -isatinanilide separates as a light reddish brown precipitate mixed with finely divided sulfur.

If the anilide is to be purified, it is filtered off and washed thoroughly with 20 per cent salt solution. The salt, freed from acid, is stirred with water containing enough soda to give a weakly alkaline reaction, and the solid mixture of the anilide and sulfur is again filtered off, washed thoroughly, and dried. It is then extracted with cold carbon bisulfide (removing the sulfur), and finally crystallized from alcohol. The purified material is in the form of dark colored needles melting at 126°C. The yield is about 150 grams of pure material from 200 grams of "thioamide." When the anilide is heated with a small excess of dilute hydrochloric acid, the aniline group is split off as aniline, and pure isatin, melting at 200–201°, is precipitated. It may be recrystallized from hot water in which it is very soluble.

Isatin is used as such in the preparation of many valuable vat dyes. Still more important are the vat dyes prepared directly from α -isatinanilide by condensation with β -hydroxythionaphthenes. As first observed by G. Engi, isatin and α -isatinanilide lead to different dyes on condensation. In the case of isatin itself, the β group is reactive in the condensation reaction, while with α -isatinanilide, aniline is split out and α condensed dyes are formed. These α condensation products are much more valuable as dyes than the isomeric β compounds.

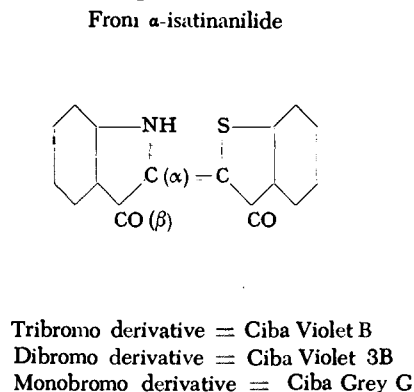
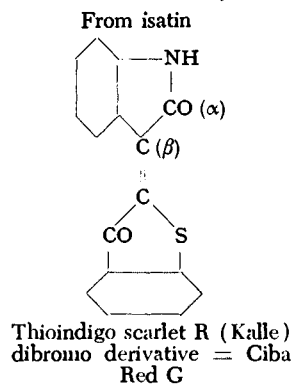
(e) α -Thioisatin and Indigo

To prepare indigo from the sulfuric acid solution of isatinanilide, it is not necessary to isolate the pure anilide or its hydrochloride. A solution of sodium hydrosulfide is prepared by introducing hydrogen sulfide into a solution of 45 grams of sodium hydroxide in 150 cc. water. This solution is mixed with the sulfuric acid solution of α -isatinanilide obtained from 200 grams of "thioamide" by pouring the two solutions into 6 liters ice water. A definite, but slight, excess of hydrogen sulfide should be present at all times. The reduction requires about 30 minutes during which the thioisatin separates as a voluminous, brown precipitate. Aniline sulfate remains in the solution. The thioisatin is filtered off when a filtered test sample of the reaction mixture gives no further precipitate with more sodium sulfide, usually after about 1 hour. The precipitate is washed until the washings have a specific gravity of only 1.007 (1° Bé) and is then stirred into 3 liters water. A concentrated solution of soda is added until a permanent, strongly alkaline reaction is obtained. This requires about 30 grams of soda. The formation of indigo takes place very rapidly, but it is desirable to heat the mixture at 60°C. for 1 hour and then allow it to stand overnight. The indigo and sulfur mixture is filtered off, washed thoroughly, and dried at 80°. The dry material is extracted with twice its weight of carbon bisulfide, leaving about 80 grams of pure indigo.

Technical Observations: The reactions involved in the Sandmeyer synthesis of indigo are surprisingly smooth. The over-all yield of dye, calculated on the basis of aniline, is about 80 per cent. The process was used for a short time by Geigy, the cost of the dye being about 10.8 francs per kilogram of 100 per cent product. This product reduced to a vat more satisfactorily than other commercial indigos and was favored by dyers. The whole process was carried out without using alcohol, since all of the materials involved reacted well in aqueous solution when sufficiently finely divided. The chief difficulty was not with the hydrocyanic acid, but with the hydrogen sulfide. This compound is a dangerous industrial poison because its odor is not noticed after short exposure. The lead sulfide was treated with concentrated hydrochloric acid to form lead chloride and hydrogen sulfide which were returned to the process. The process of the Deutsche Gold- und Silberscheideanstalt replaced the Sandmeyer process soon after large scale manufacture of indigo was started. The yields in the new process were as high as 85 per cent, so the older process could not compete with it.

Thioindigo

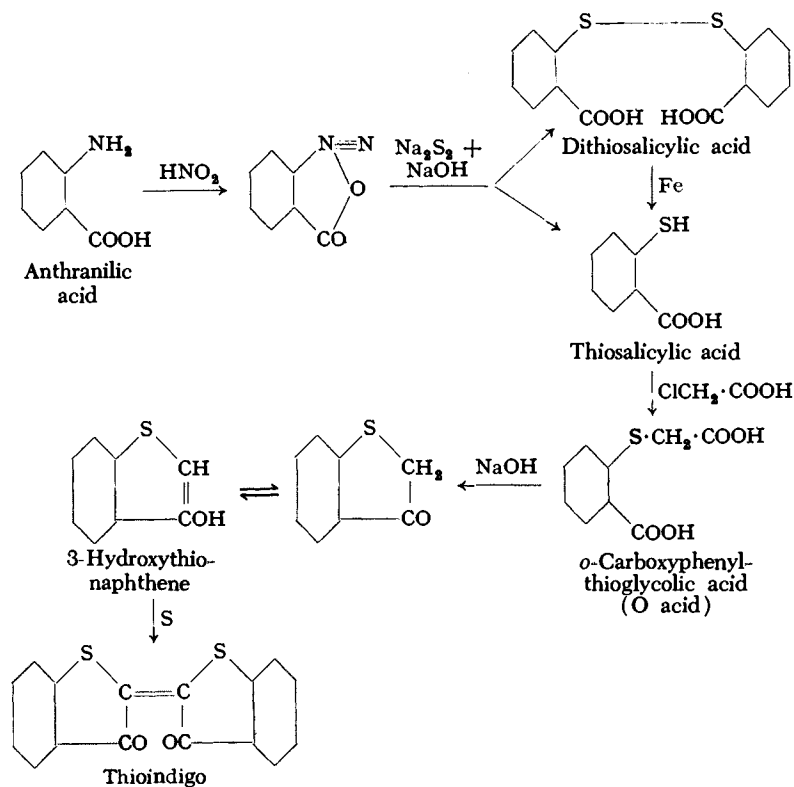

Anthranilic acid is diazotized and the diazonium salt is converted to a mixture of thiosalicylic acid and dithiosalicylic acid by the action of sodium polysulfide. For these reactions, the following three solutions are prepared:

- I. 68.5 grams anthranilic acid (0.5 mole)
500 cc. water
78.5 grams hydrochloric acid (21° Bé)
- II. 34.5 grams sodium nitrite (100 per cent)
75 cc. water
- III. 85 grams sodium sulfide, cryst. ($\text{Na}_2\text{S} \cdot 9\text{H}_2\text{O}$)
11.1 grams flowers of sulfur
100 cc. water

Solution I is prepared by adding the anthranilic acid to the aqueous solution of the acid. Solution III is made by boiling the sulfur in the

sulfide solution until clear, and then adding 12 grams of 40° Bé sodium hydroxide solution to it. Solution I is cooled to 0°C. with vigorous stirring in a 1-liter beaker, and Solution II is added slowly to it. The temperature rises to about 5°, and starch-iodide paper gives a weak blue reaction. Solution III is now mixed with 500 grams of ice in a 4-liter beaker and, with vigorous stirring, the diazonium solution is added portionwise in the course of 10 minutes. The mixture foams heavily and a yellow precipitate is formed. The mixture is stirred for 2 hours and then made acid to Congo red by adding 90 grams of 21° Bé hydrochloric acid. The precipitated thio- and dithiosalicylic acids are filtered off and washed until free from acid. Before the precipitate is worked up, the dithiosalicylic acid must be reduced to thiosalicylic acid. The mixture of acids is placed in a 2-liter beaker with 500 cc. water, 25.8 grams of soda ash is added gradually with stirring, and the solution, which must be acid to litmus, is heated to boiling. Reduction is effected with 100 grams of Béchamp iron (page 77) at 95° for 2 hours, replacing, from time to time, the water lost by evaporation. To determine when reduction is complete, a sample is removed, made strongly alkaline, boiled for a short time, and filtered. The filtrate is then treated with hydrochloric acid, and the precipitated acid is filtered off, washed, and partially dried on a clay plate. It must be easily soluble in cold alcohol. (Dithiosalicylic acid is very difficultly soluble in alcohol.)

When the test is satisfactory, the reaction mixture is made alkaline by the addition of 60 grams of 40° Bé sodium hydroxide solution, and at 95°C. a solution of 52 grams of chloroacetic acid and 29 grams of soda ash in 150 cc. water is added. The mixture, which must be alkaline at all times, is held at 90° for 30 minutes, and is then cooled and allowed to settle. The residue of iron is filtered off and washed with dilute sodium hydroxide solution. The O acid is precipitated from the filtrate by adding 150 grams of 21° Bé hydrochloric acid. This precipitation is most satisfactory when the solution is cold, and it is desirable to carry it out as slowly as possible and with good mechanical stirring. The product is filtered off, washed until free from acid, and dried at 80°. The yield is about 85 grams, or 80 per cent of the theoretical amount.

(b) 3-Hydroxythionaphthene

A mixture of 50 grams of well dried O acid and 100 grams of technical sodium hydroxide is ground in a ball mill for 24 hours. The mixture is then placed in a vacuum baking apparatus (Fig. 30, page 181) which is evacuated and heated, as uniformly as possible by means of an oil

bath, to 205°C. during the course of 2 or 3 hours. This temperature is maintained for 24 hours, after which the product is removed. It is uniformly yellow in color and weighs about 135 grams.

(c) **Thioindigo**

The product from (b) is dissolved in 1 liter water and treated with 50 grams of concentrated sulfuric acid, previously somewhat diluted. 40 grams of flowers of sulfur is added and the mixture is stirred for 3 hours at 95°C., adding water from time to time. The resulting dye is allowed to settle, and is then filtered off, washed with water, and dried at about 80°. The yield of thioindigo is about 25 grams, or 70 per cent of the theoretical amount based on the O acid. The product contains some sulfur and can be purified by alkaline reduction and reoxidation.

I. SULFUR FUSIONS

Primuline

Chloramine Yellow FF (Naphthamine Yellow NN)
and Thiazole Yellow

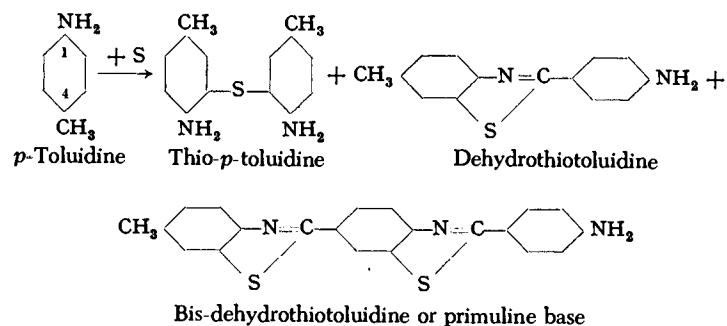

In general, the reaction of sulfur with an aromatic amine gives a substitution product in which the aromatic nuclei of two molecules are connected through a sulfur atom. Such reactions, however, always give mixtures of products, and it is usually impossible to obtain an individual reaction product. Thus, the reaction between sulfur and *p*-toluidine leads to three products which are easily recognized: thiotoluidine, de-

hydrothiitoluidine, and bisdehydrothiitoluidine. The structures of these are given above.

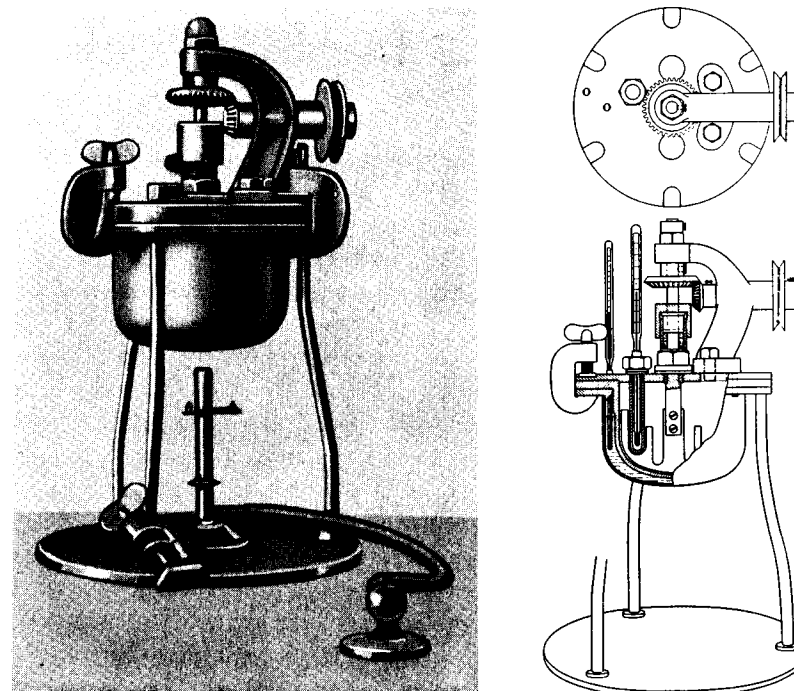

Fig. 36. Iron fusion kettle with copper oil bath for use in primuline, indigo, and alkali fusions, etc. Capacity, about 450 cc.

A mixture of 214 grams (2 moles) of *p*-toluidine, 140 grams of powdered sulfur (not flowers of sulfur!), and 2 grams of soda ash is heated to 180°C. in the kettle, equipped with stirrer and reflux condenser, shown in Figure 36a and b. (The soda is added to neutralize traces of acid always present in sulfur. If the soda is omitted, the primuline melt is always dark colored or black.) Hydrogen sulfide is evolved and collected either in sodium hydroxide solution or in towers filled with moistened sodium hydroxide sticks. After about 8 hours when the evolution of hydrogen sulfide abates, the temperature is raised slowly to 220° and held at this point for 5 hours. Hydrogen sulfide evolution now practically ceases, and the melt is ladled out onto a flat rimmed plate where it solidifies to a light yellow, crystalline cake. The yield is 325 grams.

Separation of the Melt

Method 1. The cooled, solidified melt is pulverized and mixed intimately with 1 per cent of its weight of soda ash which serves to prevent clumping in the sulfonation. 100 grams of the melt is added to 300 grams of 100 per cent sulfuric acid at any desired temperature. When solution is complete (about 1 hour), the mixture is cooled to 25°C. with continuous stirring, and 200 grams of 66 per cent oleum is added, over a period of 1 hour, with good cooling and stirring, keeping the temperature below 30°. The mixture is stirred for 5 hours at 30°, and then the temperature is raised to 40° and held there until a test sample dissolves completely in dilute ammonia. This point is usually reached in 10 hours, but it is desirable to heat even longer since complete sulfonation facilitates the subsequent filtration. The mixture is then poured into a mixture of 500 grams of ice and 500 cc. water and is filtered after 12 hours. The mixed sulfonic acids are washed thoroughly with cold water to remove the greater part of the toluidine- and thiotoluidinesulfonic acids. When the wash water gives only a weak mineral acid reaction, the residue is dissolved in about 50 grams of 20 per cent aqueous ammonia and 800 cc. water, and the solution is heated to 80° and made up to 1200 cc. The difficultly soluble ammonium salt of dehydrothiitoluidinesulfonic acid separates out completely in the course of 2 days and is filtered off and washed with a small amount of 5 per cent ammonia solution. The mother liquor contains the primuline which is precipitated by adding salt (15 per cent by volume) to the boiling solution. The yield of the dried ammonium salt is about 25 grams, that of primuline about 80 grams of concentrated material.

Method 2. The finely pulverized melt is extracted with alcohol of at least 90 per cent strength. The toluidine, thiotoluidine, and dehydrothiitoluidine go into solution leaving a pure primuline base behind. The alcoholic extract is evaporated to dryness, and the toluidine and part of the thiotoluidine are driven off by heating to 250°C. Sulfonation of the primuline base is done with 25 per cent oleum.

Method 3. Sulfonation is carried out exactly as in the first method. The washed sulfonic acid is dissolved at 80°C. in 20 parts of water and the required amount of sodium hydroxide; sufficient salt is added to make an 8 per cent salt solution, and the mixture is filtered at 75°. The primuline remains behind, while the dehydrothiitoluidine stays in solution in the form of its soluble sodium sulfonate and is subsequently salted out.

phenols and amines to produce colors fast to washing. β -Naphthol gives primuline red, a dye once used in enormous quantities. Its fastness to

Primuline, discovered by Green, was the first commercial yellow direct dye which could be diazotized on the fiber and coupled with washing is good, but its light fastness is unsatisfactory. Also, it is not

discharged to a white, but only to a yellow, since the primuline base withstands all discharging agents.

Naphthamine Yellow NN (also FF) and Thiazole Yellow

In the early days of primuline manufacture, dehydrothiitoluidine was a by-product and was remelted with sulfur to make primuline base. Today, the situation is reversed, and the previously worthless dehydrothiitoluidine has become the main product, while primuline is the by-product. The dehydrothiitoluidine can be obtained pure by vacuum distillation.¹⁰¹ Unfortunately, it is not possible to conduct the fusion so that only the simple dehydrothiitoluidine is formed; statements to the contrary are incorrect.

Various types of dyes are prepared from dehydrothiitoluidine. The free base or its sulfonic acid is diazotized and coupled with various naphtholsulfonic acids such as, for example, ϵ acid (1-naphthol-3,8-disulfonic acid). The resulting dye is characterized by its high purity of color and can be discharged to a pure white. Such red direct dyes are sold under various names, and are usually referred to as dyes of the erika red type. (Erika Z is the combination from dehydrothioxyloidine and ϵ acid. 1-Naphthol-3,6-disulfonic acid gives a very similar dye.) In addition to the true azo dyes from dehydrothiitoluidine, two other products are made which are important yellow dyes. One of these dyes is the naphthamine yellow NN (also called chloramine yellow) (Kalle), formed from dehydrothiitoluidinesulfonic acid by oxidation with sodium hypochlorite. The other is thiazole yellow or Clayton yellow, which is made by combining the diazo compound of dehydrothiitoluidinesulfonic acid with a second molecule of the same compound to form a diazoamino compound.

It should be noted in passing that alkylation of primuline produces beautiful yellow basic and acid dyes which, however, have no great importance (thioflavine T and S).

Naphthamine Yellow NN

Dehydrothiitoluidinesulfonic acid—N

||

Dehydrothiitoluidinesulfonic acid—N

A solution of 67.4 grams (0.2 mole) of the pure (100 per cent) ammonium salt of dehydrothiitoluidinesulfonic acid (equivalent to 14

¹⁰¹ Cf. Brunner, *Dissertation*, Zürich, 1943.

grams of sodium nitrite) in 300 cc. water containing 8.2 grams of pure sodium hydroxide is boiled to expel ammonia. Traces of ammonia interfere with the oxidation. When the odor of ammonia has disappeared (about 1 hour), the solution is made up to 500 cc. and cooled to 20°C., and 10.5 grams of hypochlorous acid in the form of a 5 per cent (approximate) solution of sodium hypochlorite is added. The strength of the ammonium salt as well as of the hypochlorite must be determined titrimetrically. The temperature rises about 4 degrees. After 1 hour, a small test sample is heated in a test tube and salted out. The precipitate should be orange, and starch-iodide paper should give a definite test for hypochlorite. If the test comes out otherwise, more hypochlorite should be added to the reaction mixture. After 5 hours, the mixture is heated to boiling, and the dye is precipitated with salt (15 per cent by volume) and filtered off. The yield is about 75 grams of strong dye.

Naphthamine yellow NN is the most light-fast yellow for cotton and is completely stable to chlorine. Because of these properties, it is widely used, especially in the United States where laundry is always treated with bleaching agents. Naphthamine yellow NN is not as pure a color as chrysophenine and is inferior also with respect to color strength.

Thiazole Yellow or Clayton Yellow

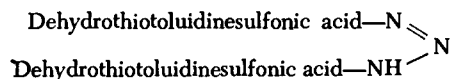

An amount of dehydrothiotoluidinesulfonic acid, equivalent to 14 grams of sodium nitrite, is dissolved in 25 grams of 30 per cent sodium hydroxide. Half of this solution is acidified with 25 cc. concentrated hydrochloric acid and diazotized at 10°C. in the course of 2 hours with 7 grams of sodium nitrite. The resulting orange yellow diazo compound is mixed with the other half of the original sulfonic acid solution to which has been added 25 grams of soda ash in a small amount of water and 25 cc. concentrated ammonia. The coupling temperature should be 4–5°, and it is desirable to have the solutions as concentrated as possible. After 2 hours, the mixture is warmed to 30° and allowed to stand overnight. It is then heated to 80°, and the dye is salted out by adding 20 per cent of salt by volume. The yield of concentrated dye is about 85 grams.

Thiazole yellow (Clayton yellow, mimosa, etc.) is, in contrast to chloramine yellow, the least fast yellow of the entire dye industry and it is really astonishing that such an inferior dye is used at all. It has, how-

ever, high color purity and strength, and is used for inexpensive dyed textile materials.

Thiazole yellow is changed by sodium hydroxide from a pure yellow to a bright red, and it can be used, therefore, as a reagent to test for alkali (thiazole paper).

Sulfonation of primuline-like color bases by the "baking" process yields sulfonic acids whose azo dye derivatives are more fast to light than those from sulfonic acids prepared in the ordinary way. It is assumed that in the "baking" process, the sulfo group enters ortho to the amino group, and that this increases the light fastness. This same principle was mentioned in connection with the pyrazolone dyes.

Technical Observations: Primuline fusions are handled in vessels heated in oil baths and having condensers supplied with warm water so that the *p*-toluidine which sublimes does not stop up the tubes. The hydrogen sulfide is collected in sodium hydroxide and used in reductions. Originally, the hydrogen sulfide was burned to heat the vessels, a procedure which is irrational in every respect and a nuisance for the neighborhood. The alcohol extraction is carried out in iron vessels having a fine sieve and filter at the bottom, and the alcohol is distilled back into the vessel just as in a Soxhlet extractor. After the alcohol is evaporated from the extract, the residue is heated to 240° until no more *p*-toluidine is being recovered.

Products analogous to chloramine yellow and thiazole yellow can be prepared from primuline, but these dyes give much muddier colors and are redder and weaker so they have found little favor.

Sulfur Black T from Dinitrochlorobenzene

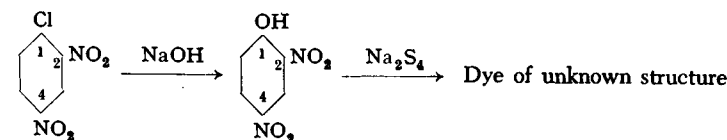

In a glass or iron vessel (such as shown in Fig. 36), 120 cc. water and 70 grams of 2,4-dinitrochlorobenzene are heated to 90°C. with stirring, and 80 grams of 35 per cent sodium hydroxide is added over a period of 2 hours. The reaction mixture should not be strongly alkaline at any time. Heating is continued until a test sample dissolves in water to give a clear solution; more sodium hydroxide is added if necessary. The suspension of sodium dinitrophenolate is cooled to 45° and mixed with a solution of 50 grams of sulfur in 125 grams of water containing 125 grams of crystalline sodium sulfide. The temperature is raised to 60° and the volume brought up to 600 cc. Then the temperature is carefully raised to 80° (water bath) and, in the course of 2.5 hours, to 105° (oil bath). The mixture is then boiled under reflux without stirring for 30 hours, and thereafter diluted with 600 cc. water. Air is passed into the reaction mixture at 60° until the dye is precipitated. It

is filtered off and dried at 70°. The yield is about 70 grams. In practice, the dye is used in boiling solution containing 1 part of dye, 4 parts of sodium sulfide (crystalline), and salt equal in weight to the weight of the cotton.

Technical Observations. Sulphur black T is the most widely used sulphur black, and is unsurpassed for washing and light fastness. It is manufactured starting with batches of 500 to 1500 kilograms of dinitrochlorobenzene. The melting kettles hold up to 12,000 liters and the oxidation vessels up to 30,000 liters. With such large batches, it is not necessary to supply heat, the heat of reaction being sufficient. The kettles are of cast iron and are corroded rapidly. The mother liquor yields sodium thiosulfate, which finds use in the photographic and textile fields. Part of it is used in the dye plant in making methylene blue. The price of sulphur black T, for about a 35 per cent product, is 80 to 90 "rappen," and its manufacture is successful only in those plants where all of the by-products are recovered. Furthermore, manufacturers who do not make their own chlorobenzene and dinitrochlorobenzene are unable to compete.

The dinitrochlorobenzene used in the preparation of sulphur black T should be free from the 2,6 isomer.

J. PHTHALOCYANINES

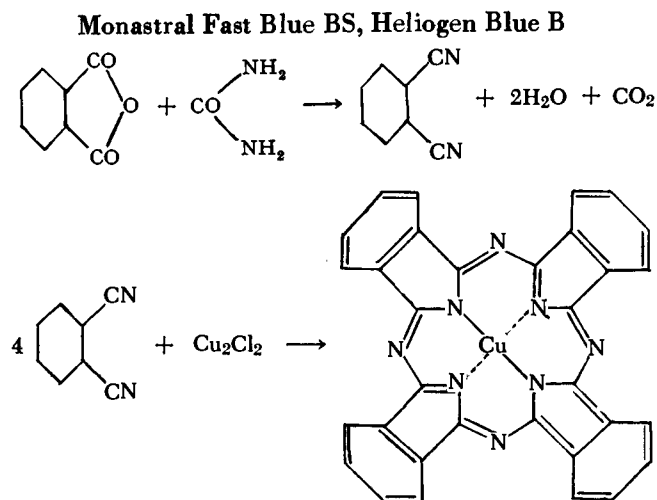

In a 500-cc. 3-necked flask, surrounded by an oil bath and equipped with thermometer, stirrer, and vertical tube, are placed 37 grams (0.25 mole) of phthalic anhydride, 40 grams of urea, 0.2 gram of ammonium molybdate, and 260 grams of 1,2,4-trichlorobenzene. The mixture is stirred vigorously and heated, during the course of 1 hour, to 195°C.

(internal temperature, oil bath temperature about 220°). This temperature is maintained as closely as possible for 4 hours while stirring is continued, and during this time 10 grams of cuprous chloride is added gradually in small portions. Care must be taken that the vertical tube does not become stopped up by sublimed phthalic anhydride, the accumulated sublimate being melted down from time to time. The mixture is then cooled, and the resulting viscous greenish-blue paste is filtered on a sintered glass funnel. The red-violet, crystalline precipitate is washed successively with hot alcohol, hot 2 N hydrochloric acid, hot 2 N sodium hydroxide, and finally with hot water, the washing with each solvent being continued until the filtrate is colorless. The product is then dried, yielding a finely crystalline, violet-blue powder weighing 27 to 28 grams (75 to 78 per cent of the theoretical amount).

Remarks. The copper phthalocyanine was first obtained by de Diesbach¹⁰² in the course of an attempt to prepare phthalonitrile from *o*-dibromobenzene by heating with cuprous cyanide. Independently, and a short time later, it was observed by Scottish Dyes that a blue dye was formed in the preparation of phthalimide in an iron container. Extensive research, especially by Linstead¹⁰³ and collaborators, showed that this blue dye was an iron derivative of the same compound obtained earlier. Linstead named the parent substance phthalocyanine and pro-

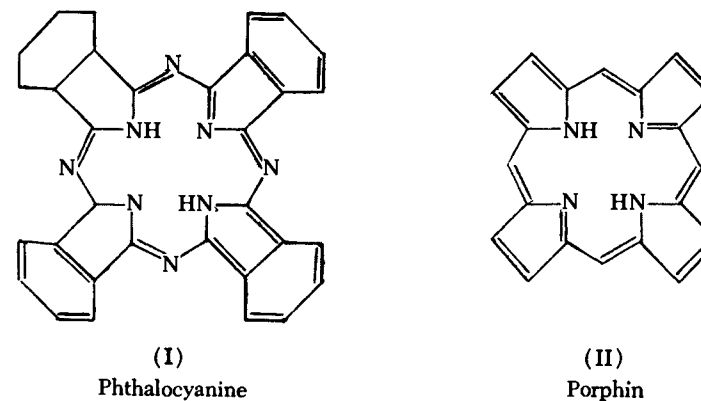

posed structure I for it. This structure is strikingly analogous to that of porphin (II), which is the basic structure of hemoglobin and chlorophyll. Linstead established that phthalocyanines are easily formed when phthalonitrile or other *o*-dinitriles, or any compound or mixture

¹⁰² H. de Diesbach and E. von der Weid, *Helv. Chim. Acta*, 10, 886 (1927).

¹⁰³ Linstead, *Ber.*, 72, 93 (1939).

which yields *o*-dinitriles on heating, are heated to higher temperatures in the presence of suitable metals or metal compounds. The phthalocyanines have a strong tendency to form complex compounds with numerous metals. The copper compound, especially, is characterized by an extraordinarily high stability. It can be sublimed unchanged at about 600° in vacuum. It can be boiled with dilute acids or caustic alkali, and can even be dissolved in cold, concentrated sulfuric acid, without being decomposed. It is completely insoluble in water and in the usual organic solvents and is extraordinarily fast to light. Thus, the compound possesses, to the highest degree, all the properties required for a pigment color.

III. Technical Details

K. VACUUM DISTILLATION IN THE LABORATORY AND PLANT

Distillation under reduced pressure, or vacuum distillation, is one of the most important techniques in the dye field. Certain products are distilled under reduced pressure because they decompose at their boiling points under normal atmospheric pressure, while in other cases, vacuum distillation has other advantages. Thus, the heat lost by radiation is less at the lower temperatures required, and furthermore, heating can frequently be done with steam so that the apparatus can be used anywhere in the plant without danger of fire. One other very important factor, which in itself is a sufficient reason for working with many substances under reduced pressure, is the easier separation of mixtures made up of compounds whose boiling points lie close together. Thus, the three isomeric nitrotoluenes can be separated satisfactorily only by distillation in vacuum, and the alkylbenzylanilines can be obtained pure only by vacuum distillation.

The laboratory apparatus used for many years for fractional distillation was poorly designed in that it did not give proper reflux ratios. Too much emphasis was placed on the *form* of the column and no attention was given to the importance of the reflux which is necessary to give a systematic washing out of the higher boiling constituents in the column. The reflux is regulated by means of a condenser above the column, arranged so that any desired amount of distillate can be condensed and returned through the column.

Figure 37a and b shows a practical glass column which is very valuable for laboratory work. The column packing consists of small glass Raschig rings in random orientation, giving excellent distribution of the returning liquid.

The partial condenser (D) is cooled by air, water, alcohol, etc., depending on the desired efficiency. For example, the condenser can be

maintained at exactly 100°C . by dripping distilled water continuously into the condenser jacket, or in larger installations, a standard condenser can be used and the cooling medium kept at its boiling point.

It is very important that a uniform rate of return of the distillate be maintained. Hence, it is necessary that the whole column be well

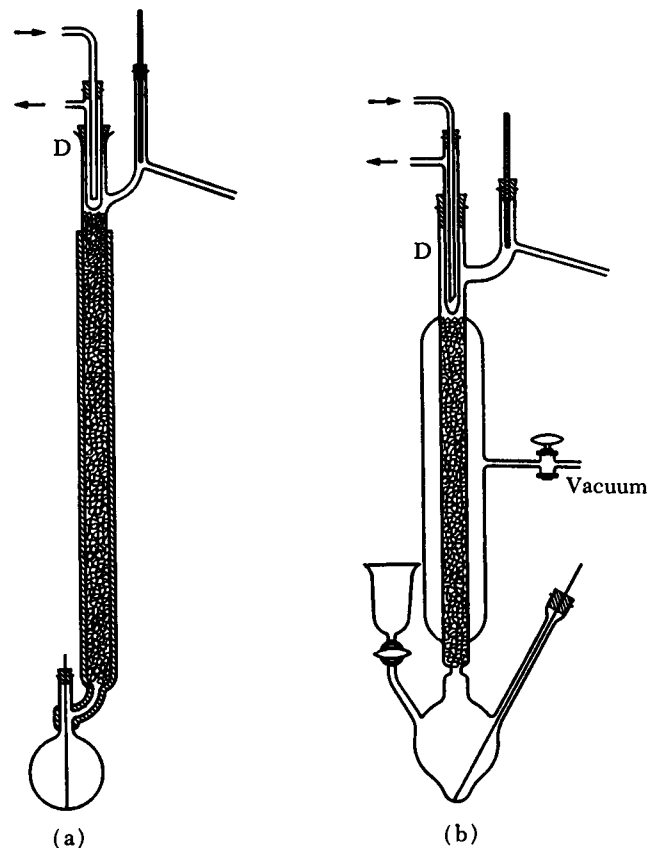

Fig. 37. Fractionating column with partial condenser (D) (dephlegmator).

insulated and protected from air currents, for example, by means of a vacuum jacket (Fig. 37b). The source of heat (for example, an oil bath) must also be kept constant. A distillation can be disturbed merely by a person passing by. It is preferable, therefore, to carry out such operations in a separate laboratory and not in the general workroom.

In addition, the vacuum must be held absolutely constant. Hence, it is necessary, when a water pump is used, that the water pressure be

great enough so that the pump does not "suck back." If the water pressure is not high enough, it may help to attach to the pump a 10-meter down-tube of sufficient width. Such a tube acts as a barometric tube and makes possible a very constant vacuum equal to the vapor pressure of the water.

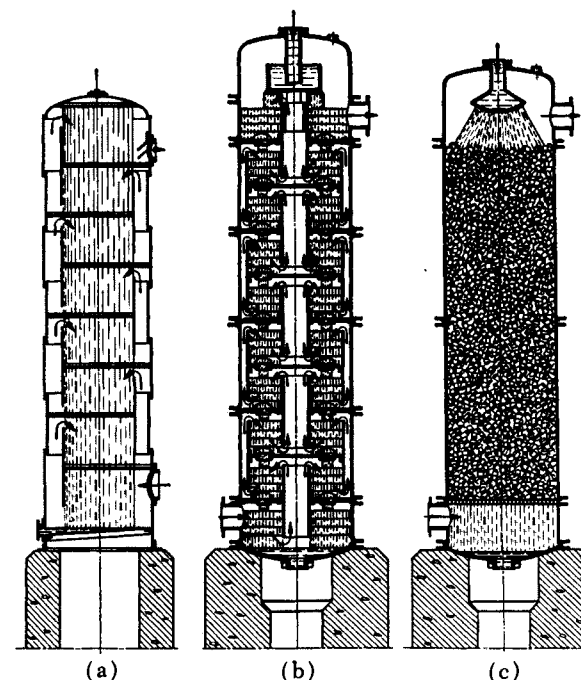

Fig. 38. (a, b) Kubierschky columns and (c) Raschig column. Diameter of columns is 50–120 cm.; height, 8–16 m. The upper portion (1–2 m.) is cooled externally in rectification operations; the rest of the column (7–15 m.) is well insulated and the top opening is closed.

An iron apparatus can be constructed for distilling larger quantities. In this laboratory, a 2.5-meter column with a 4-liter distilling flask has been in use for many years.

Separation of isomeric nitrotoluenes, chloronitrobenzenes, etc. is easily accomplished with columns of this type. Some mixtures, whose constituents have boiling points very close to each other, can be fractionated *provided that the substances crystallize* so that the pure compounds can be separated from the eutectic mixture by centrifuging. An example is the mixture of nitrochlorobenzenes, described on page 90.

On the other hand, a mixture of *o*- and *p*-chlorotoluene, for example, can not be separated. A test must be made with fairly large amounts of material to learn whether any particular mixture can be separate.

Industrial fractionating columns are constructed in a similar way, and special designs have been evolved to achieve efficient contact between vapor and reflux. Some of these columns are shown in Figure 38. In large equipment, heat is supplied by superheated steam, or oil, or by direct firing in cases where good fractionation is not necessary, such as in the distillation of aniline, naphthol, or diphenylamine. Figure 40 shows a very simple vacuum distillation arrangement which works very well despite its apparent primitiveness. Frequently, it is important that a trap be installed between the vacuum pump and the receiver to prevent any sublimate from getting into the pump. Many manufacturers supply equipment of this kind.

The vacuum is produced by reciprocating pumps which reduce the pressure to about 50 mm. of mercury. Lower pressures, down to about 8 mm., can be obtained by using two pumps in series, but this practice is undergoing change. In recent years, rotatory pumps have been finding increasing use. One type of these pumps is shown in Figure 39 which is drawn schematically to show the mode of action. The moving slide bars enclose a certain volume of air and drive it toward the exhaust opening, compressing it in the process. The machine can be used either as a compressor or as a vacuum pump to produce about 4 atmospheres of pressure or a vacuum of about 12 mm. As shown in the illustration, the apparatus must be equipped for cooling. The pump is coupled directly to a multiphase motor operating at 1500 to 2000 r.p.m., and a minimal loss of power in transmission is entailed. Frequently, two rotatory pumps are used in series.

Vessels of very large dimensions are often used for vacuum distillation of liquid materials. Aniline, for example, is distilled in quantities of 20,000 kilograms or more in vessels equipped with steam coils. β -Naphthol and like substances must be handled in smaller quantities, but even with these, 200 kilograms or more are distilled at one time using a different kind of apparatus. The high distillation temperature of β -naphthol does not permit the use of steam heating, although promising results have been obtained with the Frederking apparatus. Generally, heating must be done by flame, gas firing being preferred because it can be regulated easily. Frequently, such distillations are carried out without the use of an oil bath, but this entails a risk of charring the residual pitch, making it worthless and hard to remove from the vessel. (Naphthol pitch is an important commercial product. It is a glassy,

black, brittle mass which is used as an insulation material in electrical sockets.) In large scale vacuum distillations, it is unnecessary to introduce air since no bumping occurs. The whole apparatus must be well insulated and all tubes, which might become clogged, must be easily accessible and arranged so that they can be heated. The receiver is jacketed for either heating or cooling. When the distillation is completed,

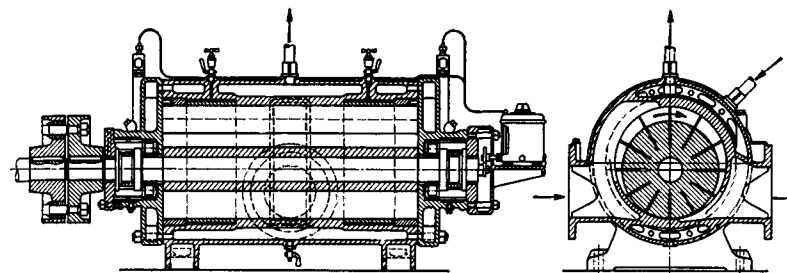

Fig. 39. Rotary compressor and vacuum pump.

the liquid distillate is forced out of the receiver in a closed system so that the fumes are not bothersome. A large trap is installed between the receiver and the pump to catch water and sublimed material. Especially in the distillation of β -naphthol, large amounts of fine snow go over and this could foul the pump.

The larger apparatus have several thermometers, one of which extends to the bottom of the distillation kettle to give the temperature of the crude mixture and to indicate the beginning and end of the distillation. When the temperature difference between the vapors going over and the residue in the kettle is about 50°, the distillation should be stopped to avoid charring the pitch.

Figure 40 shows an apparatus for the distillation of β -naphthol. It is heated by gas (three ring burners) and is designed for about 1000 kilograms. A distillation requires about 4 hours. The residual pitch amounts to about 5 per cent of the crude naphthol. (Most distillation apparatus for naphthol have stirring mechanisms so that no charring occurs at the bottom of the kettles.) The distilled naphthol is allowed to solidify in lumps and is centrifuged, after the product has been pulverized.

For distilling liquids, coil condensers are used, or, in some cases, straight-tube condensers with multiple tubes (20 to 30). These condensers can also be heated, so that diphenylamine or other easily melted products can be handled in them in the event that it is not feasible to use steam distillation (see pages 140-142).

A window is often installed in the downward portion of the condenser to permit observation of the stream of liquid.

The arrangement sketched in Figure 41 is very satisfactory for laboratory distillations. The distillation flask has two necks carrying, respectively, a fine capillary and a thermometer. The double neck arrangement also prevents spray from being carried over. Usually the flask is heated, not directly, but in an oil bath which is at a temperature 30 to 40°

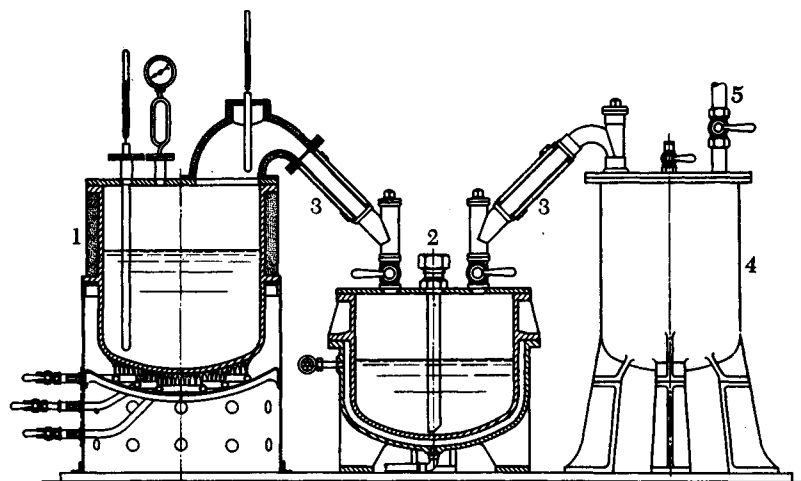

Fig. 40. Vacuum distillation equipment for substances which solidify easily (naphthols, phenylenediamine, etc.). The apparatus for large quantities (1000–3000 kg.) is equipped with a stirring mechanism to prevent charring. 1, distillation vessel; 2, receiver with steam or water jacket; 3, steam heated tubes to prevent solidification; 4, trap to collect water and sublimate; 5, line to pump.

higher than the distillation temperature. The capillary is drawn out from an ordinary thin-walled tube. It should be as flexible as a silk fiber and reach to the bottom of the flask. The upper end is closed by means of a rubber tube and screw clamp. Enough air is introduced during the distillation to make it run smoothly.

An ordinary distillation flask with a long neck is used as a receiver. If various fractions are to be collected, the distillation is interrupted after each fraction, and the receiver is changed. This operation takes only a short time. The manometer is not put in the line with the pump, but is attached through a special tube so that no liquid can get into it. It is important to have a safety cock in the system so that a small amount of air can be admitted, and the distillation immediately brought under control if the liquid in the distilling flask begins to boil over. The

pump should be separated from the distillation flask by a large safety flask. It is recommended also that the pump be installed directly onto the main line so that it will not be affected by fluctuations in water pressure.

In many cases, a so-called “sword” or “sausage” flask can be used instead of the arrangement described. This is especially to be recommended for the beginner.

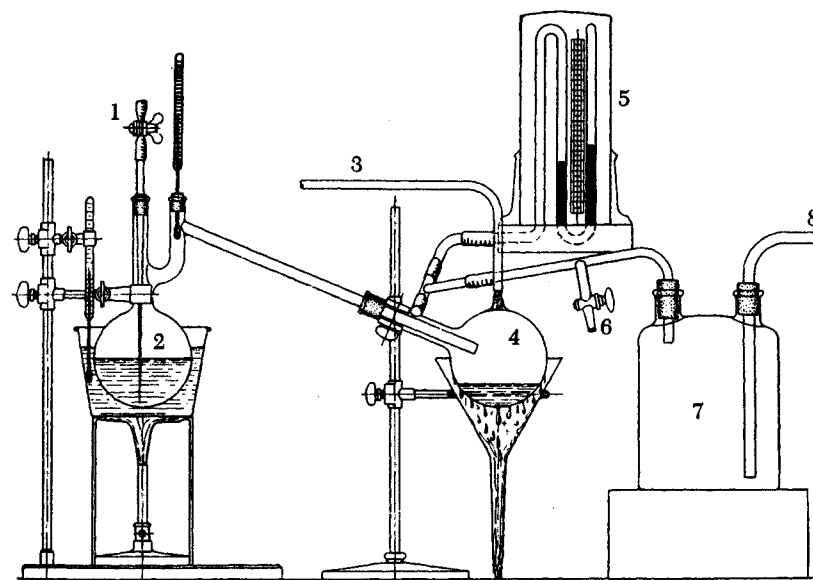

Fig. 41. Laboratory vacuum distillation set-up. 1, rubber tube and pinchcock; 2, Claisen flask and capillary tube; 3, cooling water; 4, receiver; 5, manometer; 6, safety cock; 7, safety flask; 8, line to vacuum pump.

Carrying Out the Distillation. The pump is started and the oil bath is heated to the correct temperature. At first, water or solvent comes over and the pressure must be regulated by means of the safety cock so it is not too low. When boiling ceases, the capillary is adjusted to give a fairly rapid stream of very fine bubbles, and after a time, distillation starts. With liquids, no difficulties are encountered, but solid substances, such as β -naphthol, naphthylamine, etc., may clog the exit tube. In this case, the neck of the distillation flask should be heated before distillation begins so that the first drops are superheated. Under some conditions, the side arm must be heated down to the cork in order to get the distillate through before it solidifies. Although there is no danger of cracking the

flask if it is made of good glass, *it is always advisable to wear goggles*. The distillation should take place rapidly. For example, 200 grams of β -naphthol is distilled in 15 to 20 minutes without trouble in cooling the receiver. The manometer is shut off from the apparatus and only connected from time to time to check the vacuum. Beginners often try to make their apparatus tight by smearing the joints with paraffin, collodion, or other material, but this is a highly undesirable practice. It is much simpler to impregnate good corks beforehand with hot, hard paraffin and then additional coating is entirely unnecessary. Rubber stoppers are used only for high vacuum distillations, but better results are obtained by using apparatus with sealed glass joints, as in the technical distillation of guaiacol, where a mercury pump is used.

The distilled material is melted by heating over a free flame and then poured out into a small porcelain dish. The solidified material is pure and is not recrystallized.

L. THE FILTER PRESS

In the laboratory, the dye chemist uses a suction funnel and flask to separate solid materials from liquids. In the plant, however, such equipment is suitable only for filtering coarse precipitates which, even in thick layers, do not offer too much resistance to passage of the liquid. Fine precipitates — and this includes the great majority of dyes — must be filtered through a filter press in large scale operations (see Fig. 56, page 376, and schematic drawing in Fig. 42a-h).

The mixture to be filtered is forced by air pressure out of the pressure chamber (blow-case) (3 in Fig. 56) into the filter press through the feed line (5 in Fig. 42a). The material passes from the entry tube (6) through the holes (7 in Fig. 42b-d) in the filter frames into the hollow spaces (8). The solid material is held back by the filters (9), while the mother liquor passes through the filters and collects in the channels in the filter plates. Thence, the liquid flows down through the holes and stopcocks, and, if it is not to be treated further, through the discharge tube (10). At the beginning of a filtration, only weak pressure is applied until the filter, especially if new, is sealed with the material, and then full pressure (generally several atmospheres) is applied. If the press is full, the mother liquor is emitted slowly, but with a batch of the correct size, it is blown out. The filtered material can be washed if neces-

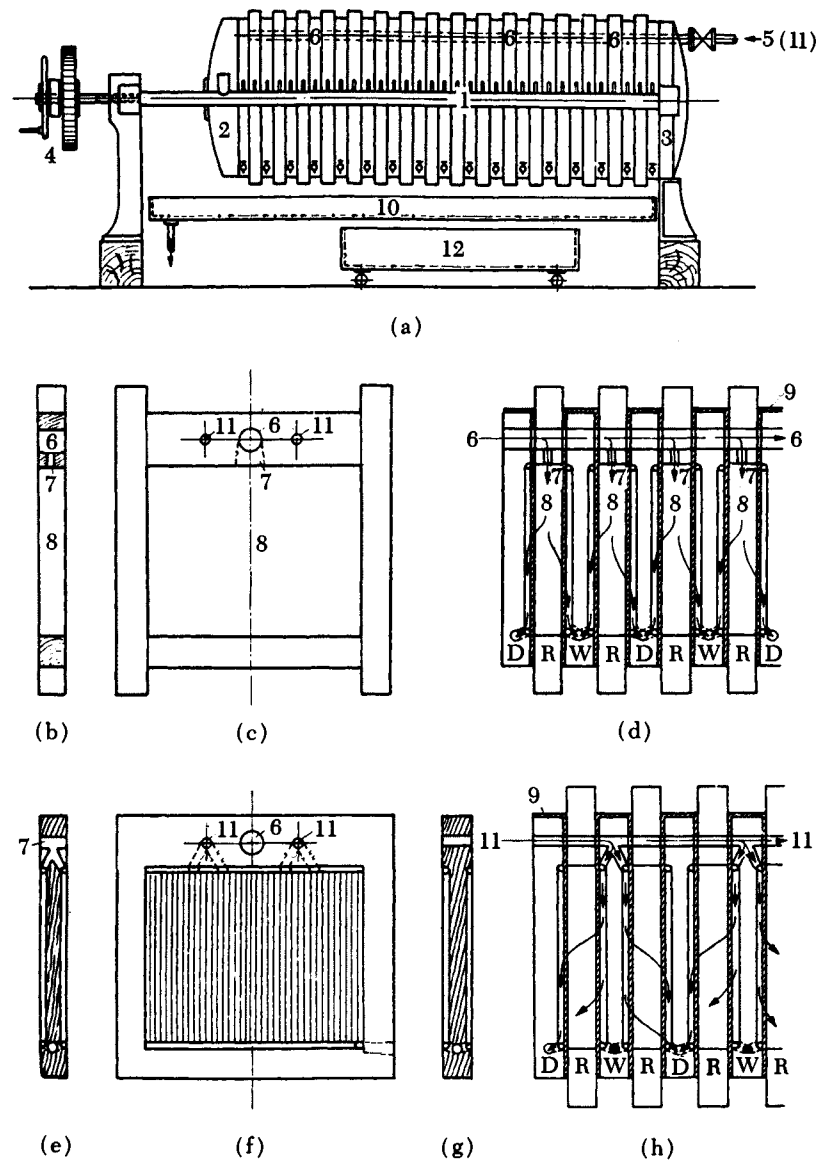

Fig. 42. Filter press: (a) assembled press; (b, c) filter frame, R; (d) filtering; (e, f) wash plates, W; (g) filter plates, D; (h) washing.

sary. This is done in the empty pressure chamber in the same way as the original filtration, or, in the case of difficultly soluble materials, by introducing water through the two side feed lines (11) in the solid head-piece which lead to the channels in the wash plates (see Fig. 42e-h). The stopcocks in the washing chamber (W) must be closed during washing. When the mother liquor has been removed and the wash water comes through clean, air is blown through the water feed line to dry the press cake. The press is then opened, the product is emptied into the box (12) and the filters are scraped with a wooden spatula.* The press is then reassembled and filtration is continued.

If the filtrate is turbid, it is collected and run through again. This should be done early in the filtration. A filter which is torn during the filtration can also be the cause of turbidity in the filtrate. If it is a part of a filter plate which runs turbid, this should be closed. If, however, it is a part of a wash plate, closing it would cause the cloudy liquid to flow back along the route of the wash water and distribute it to all the wash chambers. In the latter case, the turbid filtrate is collected separately and returned to the filter.

A more complete description of the numerous special types of filter presses, and of other industrial filtering equipment, is given in other places.¹⁰⁴

M. THE CONSTRUCTION AND USE OF AUTOCLAVES

Autoclaves, or pressure vessels, are used chiefly for reactions where the temperature exceeds the boiling point of one of the ingredients, or where gases, which are essential for the reaction, are evolved on heating. In the dye industry, aqueous solutions and mixtures are usually involved, but alcohol and alkyl chlorides also play an important part. Pressures up to 60 atmospheres and temperatures up to 300°C. are used. The apparatus usually does not permit the use of more drastic conditions.

Vertical and horizontal autoclaves, with and without stirring mechan-

* This involves a relatively large amount of hand work and as a result the operation of filter presses is more costly than that of suction filters or centrifuges. The latter are preferred, therefore, if the properties of the precipitate permit their use.
¹⁰⁴ See, for example, Ullmann, *Enzyklopädie der technischen Chemie*. 2nd ed., Vol. 5, Urban und Schwarzenberg, Berlin, 1928, p. 358 ff.

isms, are manufactured. If the reaction mixture is homogeneous, as in the preparation of dimethylaniline, there is no need for stirring. If, on the other hand, there are various solid layers or a mixture of solid and liquid in the reaction mixture, continuous stirring is an essential. An example of a reaction mixture which must be stirred is alkali fusion.

The pressure vessels are hollow cylinders, of 100- to 10,000-liter capacity, having a flange onto which the cover is fastened by means of bolts and nuts. The bottom of the vessel is usually hemispherical for greater strength. Autoclaves are almost always made of iron, either cast steel or cast iron, the former being safer to use at high pressures. Sheet iron is also used, in wall thicknesses up to 40 mm., in either riveted or welded construction. The reluctance in many dye plants to use welded autoclaves is entirely unjustified and has arisen simply because in the early days of the industry welding processes had not been perfected.

The weakest point in any autoclave is in the bolts, and these, therefore, are always made from the best hand-forged ingot iron. The cover is cast with supports for attaching the fittings and stuffing box for the stirrer (see Figs. 43 and 44). The support for the stirrer gears should be high enough so that the packing in the stuffing box can easily be inspected and removed from time to time. The stuffing box itself, through which the stirrer shaft operates, should be of simple construction and water cooled. Some of them are made hollow so that water can be circulated through them. Cooling by circulating oil, or labyrinth packing, such as are successfully used in steam turbines, are not necessary here where the requirements are quite different. The cover is also fitted for two manometers and two thermometers, as well as two outlet valves with steel plugs. In recent years, the safety valves have been dispensed with in certain cases because they frequently do not function correctly and regularly cause trouble. The process can be followed exactly by the use of two manometers and two thermometers. In large autoclaves, the cover also has a special opening for filling (manhole), and only this is opened regularly. The cover is provided with a special packing ring which extends into the flange of the autoclave. This ring must be accurately turned and is from 20 to 50 mm. wide and 1 to 6 mm. thick. Copper, lead, leaded iron, and asbestos paper are used as packing materials. Lead is easily pressed out by the pressure of the bolts, but resists ammonia very well; copper is an ideal packing except that it is attacked by ammonia. Asbestos can often be used with low pressures, but it has the disadvantage that the packing is almost always torn when the autoclave is opened. The cover is fastened down by tightening opposite bolts around the circle, lightly at first, then more tightly, and

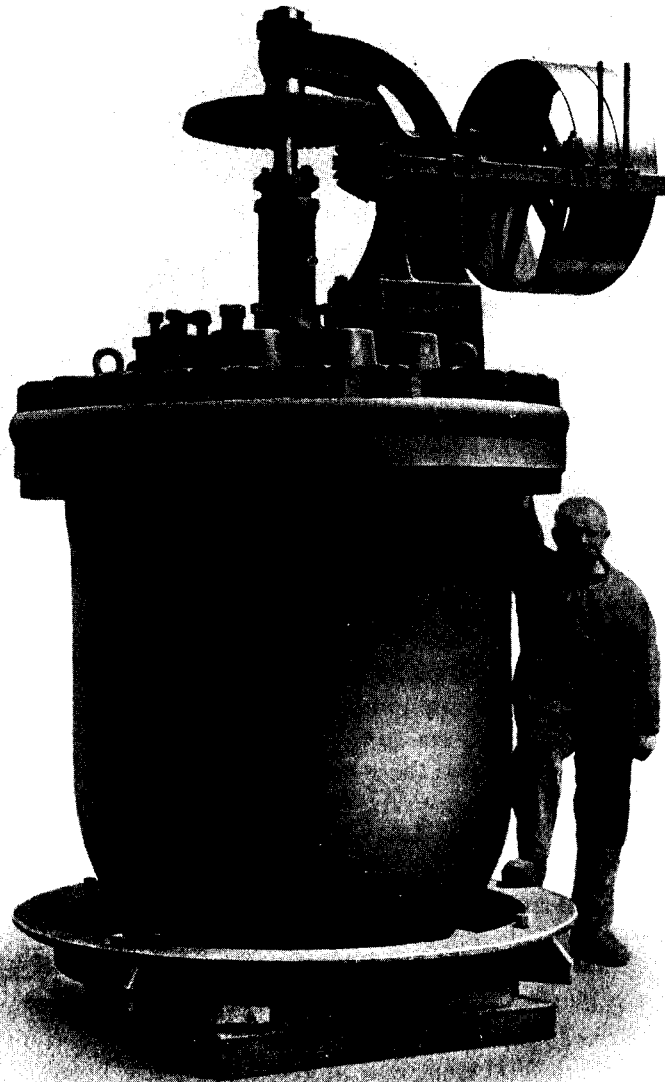

Fig. 43. Cast steel works autoclave. Capacity is 1500 liters; maximum pressure, 40 atm. The stuffing box is too close to the stirrer mount, making it difficult to install the packing.

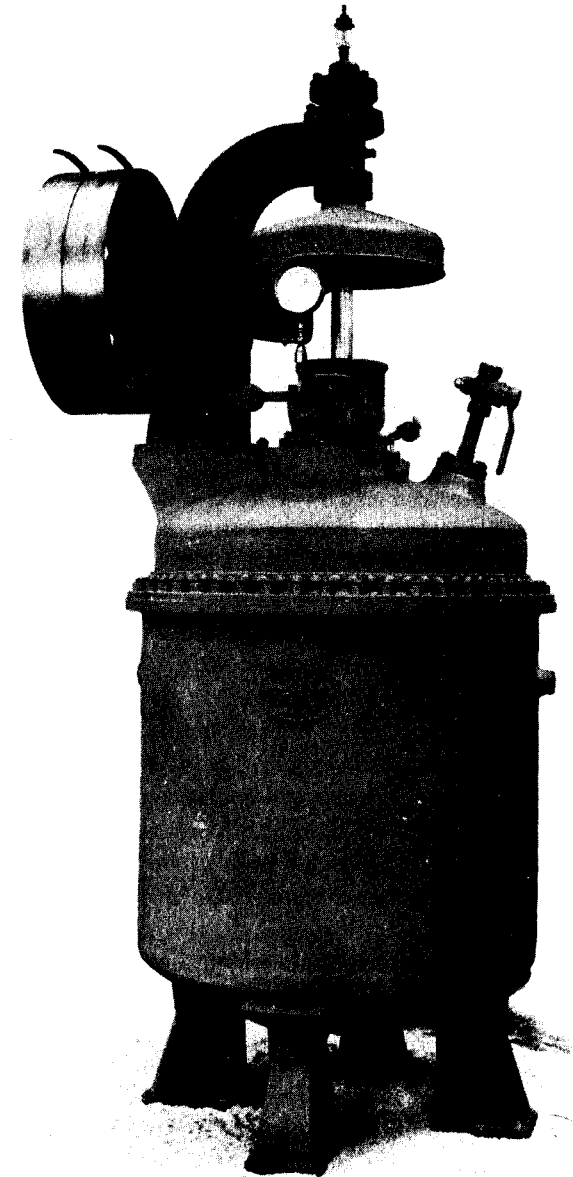

Fig. 44. Cast iron works autoclave with steam heating. Capacity is 1400 liters; maximum pressure, 25 atm. The stirrer mount is high so that the stuffing box is easily accessible. Samples can be removed through the cock seen at the upper right.

finally by using a heavy lead hammer at the end of a long wrench. In this way, there is no danger of stripping the threads.

The autoclave itself should not come in direct contact with the materials being handled in it, since any melt will attack the walls and the apparatus will be weakened after a time. Hence, a liner is almost always installed, set in with solder. It is not feasible merely to set the liner in the autoclave since then the heat transmission is not sufficiently good. To install the liner, it is suspended rigidly from a strong cross beam and the metal is poured in through an iron funnel. Enamel and lead are protected by covering the inner side of the liner with wet cloths. It is also possible to fill the liner with water, but the water should be heated a little at the beginning and then cooled by water coils. If the water is not heated, the solder may not get completely to the bottom before it solidifies; the later cooling is necessary to prevent all of the water from boiling off.

Inadequate heat transfer can be caused not only by an air space, but to an even greater extent by salt crust formation on the inside of the vessel. Hence, mixtures from which salts separate must always be stirred, and the stirrer should come as near to the walls as possible in order to keep them free from incrustation. When large amounts of salt separate, even the best stirrers are inadequate. One case is known where a salt crust only 4 cm. thick resulted in overheating an autoclave to the point where it was red hot. At an internal temperature of 240°C. and pressure of 48 atmospheres, the autoclave was blown out like a balloon and the bottom split. The escaping gas cooled the steel enough so that no further danger was involved. It is almost certain, however, that cast iron would have exploded. (Fusions such as those in the preparation of β -naphthol, if done without a metal bath, would certainly ruin any pressure vessel.)

For these reasons, it is essential, whenever possible, to place the autoclave in a heating bath. Oil or solder are used as the heating liquids. Even when no salt crusts are formed to interfere with heat transfer, phenomena occur at higher temperatures which make the use of a solder bath desirable. The solder surrounding the liner is melted if the autoclave is heated directly, and this results in the liner being lifted. Finally, the liner is pressed against the autoclave cover and, after cooling, prevents proper tightening of the cover. After a time, leaks develop, and forcing the nuts to overcome the difficulty is a source of great danger. Incorrect heating is bad not only for the autoclave but also for the compounds involved. The cases of α -naphthol and β -naphthylamine have already been discussed in detail.

The autoclave is charged through the manhole, and this is then closed carefully, or, if possible, the material is drawn in by suction through the emptying tube. The latter procedure gives less chance for formation of leaks. Since water expands considerably when heated — about 20 per cent from 0 to 250°C. (Mendelejew) — an autoclave should not be filled to more than 80 per cent of its total capacity. If the vessel is too full, the pressure becomes so high that the autoclave will be split. A table should be posted over every autoclave, listing the total volume, maximum pressure, maximum charge, and the type of liner.

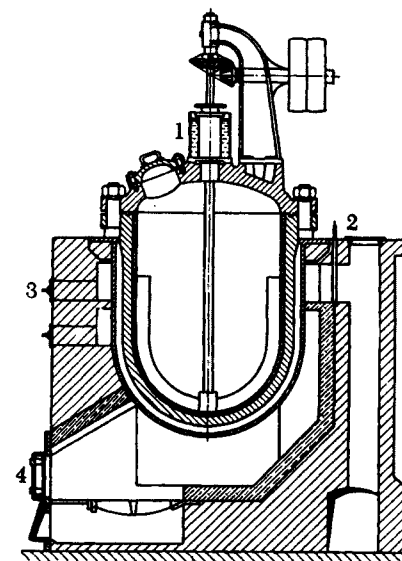

Fig. 45. Cross section through an autoclave.

Pressure equipment is designed by engineers who have official standards upon which to base their work. It is recommended practice, nevertheless, to have each apparatus checked by a first class firm before application is made for a permit for the project.

The autoclave is installed in the previously completed masonry structure by means of a traveling hoist. The walling should be reinforced by iron rods, spaced 30 cm. apart, whose protruding ends are anchored with iron plates measuring 25 by 25 cm. The autoclave or its heating bath is set on a sunken ring (seen at the bottom in Fig. 43), and the apparatus is filled and heated. If the installation has been made properly, there is no need to proceed with excessive care in this first heating, although

it is usually best to start out with a small flame. The rods of the grate should be kept free, and if necessary one or more of them should be removed in case the draft is insufficient. It is recommended that a separate chimney be used for each two large autoclaves, so that the autoclave operations are not dependent on neighboring apparatus. In general the heating period is several hours. Once the masonry is hot, a small fire is sufficient to keep the temperature up. The radiation becomes so large at temperatures above 200°C. that the part of the autoclave extending out of the fire box must be insulated with a sheet iron cover lined with asbestos. This insulating cover is made in sections so that when the apparatus is to be cooled, the cover can be removed and the fire door and the soot door can be opened. Cooling of the autoclave can be greatly accelerated by blowing off part of the contents (into a condensing system in the case of alcohol or ammonia), and in this way the masonry does not lose much heat, which is important for the next operation. The autoclave must be watched carefully during the heating operation. The temperature of the oil bath should be about 30° higher than the inner temperature, and the two thermometers (also the two manometers) should agree with each other to within 2 scale divisions. If they show a greater difference, the thermometers should be checked, and if necessary, the operation interrupted. The operation of an autoclave can be supervised from the laboratory by means of remote-recording thermometers, and recording manometers are being used increasingly since they give records which can be checked even after the operation is completed. All observations should be recorded accurately, so that a record is available in all cases of interruption or accident. If, despite all precautions, real trouble arises, such as a sudden, unexpected increase in pressure or temperature, the fire is raked out without delay, the valve and soot door are opened, and the immediate vicinity of the autoclave is evacuated. Explosion of an autoclave, such as those shown in Figure 43 and 44, can wreck a whole plant. Since all pressure vessels are built with great care, however, no danger is involved if they are operated properly.

Every pressure vessel must be inspected officially each year, at a time when it is cooled and thoroughly cleaned out. The apparatus is entered only after it is shown that a candle burns normally inside. Usually, only the manhole is opened and the apparatus is blown out with compressed air. Two people should always work together, and the results of the inspection should be certified officially. Frequently, a gauge can be used to measure accurately any change in the walls of the vessel. The liner must be removed for inspection. The autoclave is

heated until the solder is melted, and the liner is raised out with a hoist. The solder is then ladled out with an iron ladle into ingot molds.

Autoclaves are usually installed in high, light rooms equipped with traveling hoists. Figure 56 on page 376 shows, in cross section, a factory layout for a dye plant with its adjoining autoclave room. The illustration shows how the completed reaction mixture is transferred directly from the autoclave to the processing rooms.

The construction of laboratory autoclaves is very similar to that of large pressure vessels. Figures 46 and 48 show two cast steel laboratory

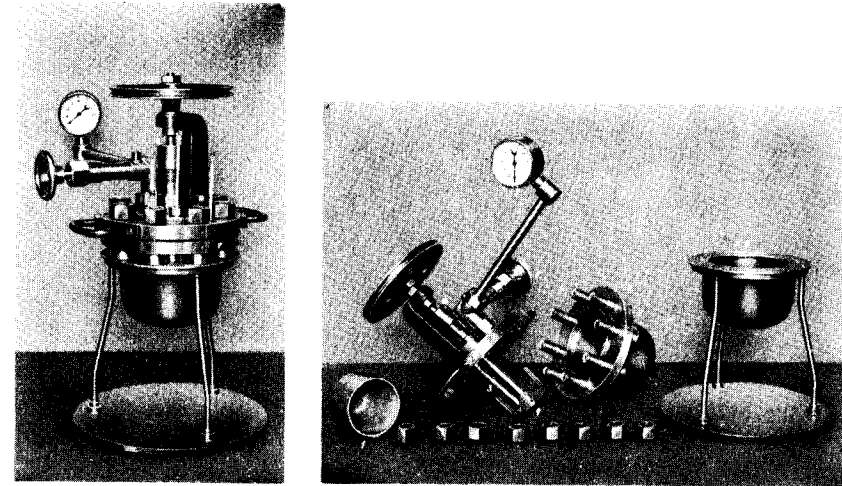

Fig. 46. Cast steel laboratory autoclave with stirrer: working pressure, 60 atm.; capacity, 1 liter; weight, 33 kg.; weight of oil bath (copper), 11 kg. 1, autoclave lining; 2, stuffing box; 3, thermometer well; 4, stirrer; 5, manometer; 6, valve; 7, autoclave body with bolts; 8, copper oil bath with iron ring.

autoclaves, and Figure 47 shows the first one in cross section. The liners must be carefully set in with lead as already mentioned. If solder is used instead of oil as a heating medium, the bath must be of iron since copper is attacked by lead. Usually, it is not necessary to cool the stuffing box on a laboratory autoclave, since only a small loss results if a leak develops. Cooling is employed only where high pressures and temperatures are involved, but, in these cases, the rotating autoclaves, described later, are to be preferred. It should be mentioned that the stirrer should rotate in the direction which will not unscrew the stuffing box nut. The cover of a laboratory autoclave is tightened carefully in exactly the same manner as described for the large equipment except that here the final

tightening by striking with a hammer is not used for fear of stripping the bolts. It is sufficient to hold the autoclave tightly and tighten the nuts as much as possible with a long wrench.

The cover of the autoclave can be either domed or flat, the latter being preferred generally, because the stirrer mount can be tightened

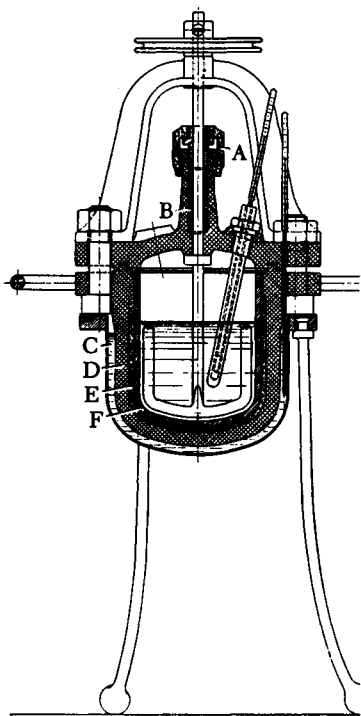

Fig. 47. Cross section through the laboratory autoclave shown in Figure 46. (A) stuffing box; (B) packing; (C) oil bath; (D) cast steel body; (E) lead; (F) liner.

more easily and the holes for the fittings can be packed more easily. The autoclave shown in Figure 48 has a domed cover with holes for the fittings.

Heating is done with a Fletcher burner, and later heat is applied by a good Bunsen burner placed directly under the center of the autoclave and not with several burners supplying heat to different areas. The autoclave should be protected from drafts by means of a sheet metal

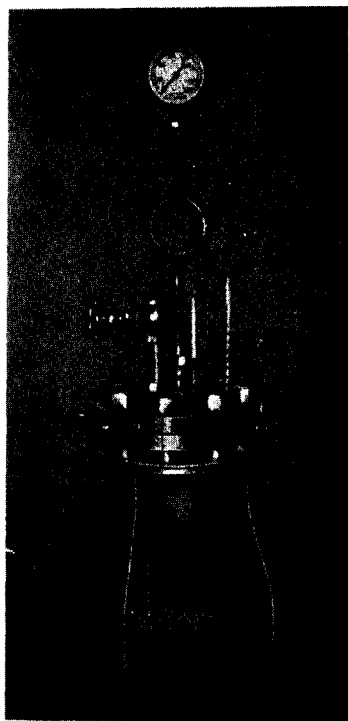

Fig. 48. Vertical cast steel autoclave: working pressure, 60 atm.; capacity, 1 liter; weight, 30 kg.

shield, resulting in a saving of gas up to 70 per cent. For cooling, the whole apparatus is raised from the bath and set on an iron triangle, letting the oil drip into the bath. Heating and cooling take only about 1 hour. In case unexpected phenomena appear, the same rules are applied, with appropriate modifications, as in large scale operations. The cover bolts should not be tightened when the autoclave is under pressure, although the bolts around the stuffing box may be. General rules governing the use of autoclaves are listed later.

Instead of using an enameled liner, the inside of the autoclave body and the cover can be enameled directly, although there are but a few

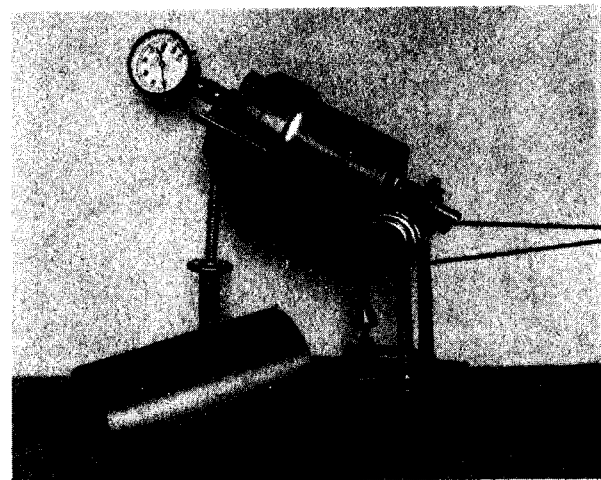

Figure 49. Rotating wrought iron autoclave with worm gear drive: weight, 11 kg; capacity, 400 cc.; working pressure, 100 atm.

firms supplying satisfactory equipment of this type. The cost of enameling varies with the weight of the apparatus.

Pressure reactions with stirring are difficult to carry out in the laboratory if the pressure exceeds about 20 atmospheres because the stuffing box must be very tight and also cooled. For this reason, the rotating autoclave shown in Figures 49 and 50 has been used in this laboratory for a number of years. It is built according to well-known principles of construction, although certain innovations have been introduced. The opening is reduced so that fewer bolts are used, and the whole body of the autoclave is made in one piece from an old wrought iron pressure cylinder. The apparatus is set on an incline, at a variable

angle, so that both pressure and temperature can be measured, care being taken that the contents of the autoclave do not come in contact with the packing. The manometer is installed in the top opening, and the thermometer, held in place by asbestos paper, is inserted in the bottom hole. The weight of the autoclave is not carried on the worm gear shaft, but by a bronze bearing on the supporting frame (Fig. 51). With

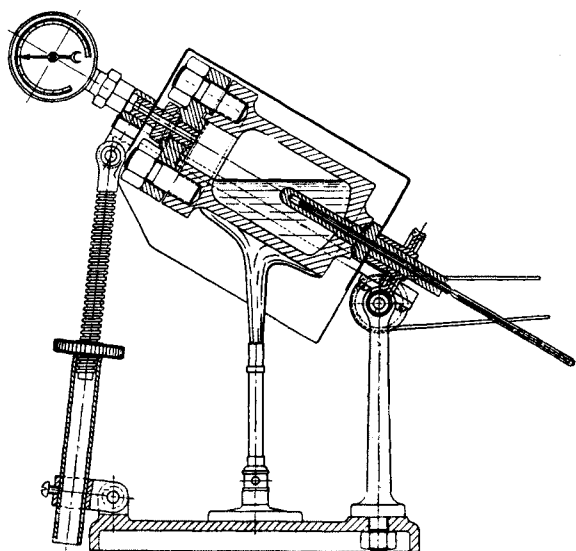

Fig. 50. Cross section through the rotating autoclave.

this arrangement, surprisingly little power is required. The apparatus weighs 11 kilograms with a charge of 400 cc. and is built for 100 atmospheres pressure. The frame weighs about an equal amount. During the heating, the cylinder is covered by a sheet metal hood, and the gas consumption is less than 20 per cent of that required with other autoclaves. Attempts to use a simple screw top closure instead of the more expensive bolt and nut arrangement were unsuccessful, because the packing, which was merely pressed against the cover when the screw closure was tightened, did not give a good seal and always blew out at about 180°C.

As shown in the sketches, the burner should be placed beneath the lower part of the autoclave which is filled with the material. In this way, overheating of the packing is avoided.

The rotating autoclave is especially suitable for handling pasty mix-

tures or suspensions of solid materials. The mixing is often inadequate if immiscible liquid layers, differing widely in specific gravity, are formed at the reaction temperature. Some improvement is obtained by adding a few steel balls to the mixture, but it is better in these cases, if the pressure is not too high, to use a stationary stirring autoclave.

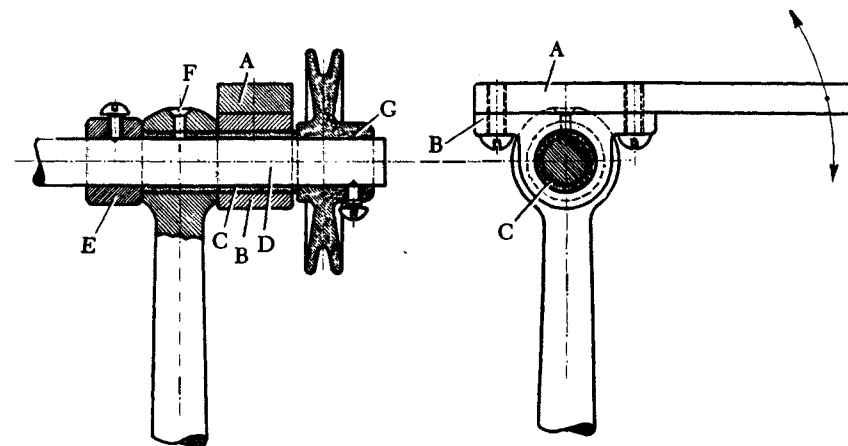

Fig. 51. Detail of the rotating autoclave: (A) support frame; (B) connecting bearing; (C) bronze bushing; (D) axle; (E) positioning ring; (F) oil hole; (G) drive pulley.

General Rules on the Use of Pressure Vessels

(1) The packing must always be clean. (2) Nuts are tightened in opposite pairs, first lightly, then increasingly tightly around the circle. (3) If the reaction mixture is neutral and does not evolve ammonia on heating, a manometer with a bronze tube can be used. If fumes which attack copper or bronze are generated, however, a steel tube manometer is used. Copper and bronze are corroded very rapidly. (4) A liner should always be used, and the solder between the liner and the autoclave body must be replaced whenever it is forced out. Only under very special conditions can the liner be dispensed with. (5) The temperature of the oil bath (or metal bath) and the internal temperature should be measured. The external temperature is about 25° higher. (6) The autoclave must be protected from drafts. To this end, it is insulated and, in larger installations, covered with a shield. (7) The reaction must be interrupted

if the vessel develops a leak. The nuts should not be tightened as long as the vessel is under pressure. The stuffing box nuts can be tightened during operation. (8) The autoclave should be opened only after the valve has been opened since the manometer may frequently not indicate residual pressure in the apparatus. (9) The oil bath and the autoclave itself should never be completely filled. Water and oil expand greatly on heating, and if the autoclave is filled completely, it will be cracked. (10) Every pressure vessel should be inspected officially once a year, and a certificate issued stating the results of the inspection. The date of the inspection is stamped on the vessel along with the capacity and maximum pressure. (11) Industrial autoclaves should be cleaned thoroughly, cooled, and equipped with an air hose before inspection. (12) The properly reinforced masonry for an industrial autoclave is prepared in advance, and the completely assembled autoclave, in working order, is set into it.

N. CONSTRUCTION MATERIALS FOR DYE CHEMISTRY

Because of the corrosive action of the chemicals used in the dye industry, careful consideration must be given to the construction materials employed. The materials which can be used for a given purpose should be specified if possible, but frequently experience, or chemical sense, so to speak, must be relied upon.

The materials of construction to be considered in the dye industry fall into two groups: (a) inorganic, including metals and nonmetals, and (b) organic, including natural and synthetic materials.

1. Metals

Iron is the most important construction material in the dye industry and is used in all possible types and forms.

Cast iron is used for sulfonation and nitration vessels, as well as for evaporating apparatus, stopcocks, stirring mechanisms, autoclaves, and all apparatus for handling neutral or alkaline liquids. Still greater use of this valuable and easily cast metal is restricted by its inadequate tensile strength.

It is well known that the properties of cast iron are highly dependent

upon its chemical composition. Ordinary gray cast iron is used as an acid-resisting metal, i.e., one which is attacked very little by concentrated acids, and its resistance may be improved by added ingredients, the identity of which is kept secret by many foundries. Gray cast iron fulfills all the requirements for use with sulfuric acid of at least 75 per cent and with mixed sulfuric and nitric acids. It becomes passive, and hence quite resistant, in fairly dilute acids also. One should never depend on good luck, however, and should rely only on an actual test to determine whether cast iron is suitable for a particular application. Furthermore, a cast iron vessel should be cleaned out carefully after each operation. After a shut-down, cast iron vessels should be washed out, de-acidified with hot soda solution, and then washed with boiling water, leaving the vessel completely dry. Wooden water baths surrounding vessels should be kept filled to prevent shrinking, and the water should be made strongly alkaline with soda to prevent rotting of the wood.

The supports for stirrers in vats, autoclaves, and other vessels are made from cast iron. Light gears should be milled, and it is desirable to mount all larger gears with ball bearings, thus saving power and lubricants. Cast iron is used for filter press stands and head pieces, but not for the drawbars because of its insufficient tensile strength. Autoclaves for use up to 40 atmospheres working pressure can be made from cast iron. Cast steel must be used for higher pressures, however, since cast iron is blistered in very large pieces and much too thick walls would be required. For example, the cast steel autoclave shown in Figure 43 has a wall thickness of 80 mm. and weighs 10 tons. With a diameter of 1200 mm. and a working pressure of 40 atmospheres, the autoclave would have to have walls 400 mm. thick if it were made of cast iron, and the vessel would weigh over 60 tons. Such a monstrosity would be unusable technically, because of the large strains which would arise on heating. Fusion kettles in naphthol plants are made of cast iron, and an addition of 1 to 3 per cent of nickel increases the alkali resistance enormously. Fused alkalis, especially potassium hydroxide, have a strong corrosive action on iron.

Cast iron having very high resistance to acids is marketed in the form of an alloy containing 12 per cent of silicon and 4 to 6 per cent of aluminum. These ferro-aluminum-silicon alloys are attacked readily only by hydrochloric acid, the most corrosive acid. They were first used in England under the names "Ironac" and "Tantiron." "Kieselguss," "Acidur," and "Clusiron" are imitations which are all easily cast, but which are very hard and brittle so that they have to be worked on an emery wheel. These alloys are exceptionally well suited for nitric acid

distillation equipment and for other special purposes. Because of their brittleness, however, they are not usable for autoclave liners.

Where high strength is important, wrought iron, ingot iron, or steel must be used. These are used for the drawbars of filter presses and hydraulic presses. (The head pieces of the latter must be of cast steel because cast iron is too weak.) Recently, welded electrosteel has also been used. Steel is also used for the spiral manometer tubes where ammonia is involved. Wrought iron is used for the bands on vats and for the reinforcing iron for concrete.

In recent years, a number of especially resistant iron alloys have appeared on the market and have been rapidly adopted. They are, essentially, nickel-chrome-iron alloys, usually containing very little carbon. These alloys are very resistant to acids and alkalis and are used chiefly where high resistance to chemicals is the deciding factor. The different VA-steels, and the English S-80, are examples of these alloys which vary in composition depending on the particular application. These alloys withstand concentrated nitric acid, and other acids, except hydrochloric, scarcely attack them at all. They are especially important in modern high pressure syntheses. Potassium hydroxide scarcely attacks these alloys even in fusion mixtures, and they are quite satisfactory, therefore, for indanthrene fusions. (Nickel is also suitable in this particular case.)

Copper was more widely used earlier, but is still indispensable today. It is used for making scoops (but not for diazotizations), for centrifuge baskets, supply lines, and especially for drying plates where it is used almost exclusively. Copper is attacked by air-ammonia mixtures and is often tinned for protection. Alcohol distillation apparatus are usually made of copper.

Tin is rarely used as such, but is widely used for alloys such as bronze* and lead-tin bath metal,† and for tinning iron and copper equipment.

Zinc, likewise, is generally not used as such, but as brass and bearing metals. It is also used as the coating on galvanized plate.

Aluminum, on the other hand, is receiving increasing attention because of its high resistance to dilute and concentrated nitric acid. It is frequently used for nitric acid feed lines and for nitrating vessels, but it is rapidly corroded by factory air.

Nickel is rarely used, except in special alloys.

* The inlet tubes on filter presses, as well as the stopcocks on dye vats, are almost always made from the best bronze.

† An alloy of equal parts of tin and lead has practically no expansion on heating.

Lead is by far the most important of all the nonferrous metals and is quite indispensable. It is found in the form of lead tubing in almost all filter presses and in lines carrying acid and alkaline liquids. Head pieces and discharge pipes of filter presses are covered with lead plate. Frequently, when lead-coated metal is heated, the lead loosens and large blisters are formed and the coating finally breaks. This difficulty can be avoided by applying the lead coating, not directly, but on an underlayer with which the lead alloys. Apparatus, in which the lead is intimately bound with the base, is said to be homogeneously leaded, and such equipment plays a very important role in the dye industry. It has been proposed by Kühnle, Kopp, and Kausch that round pieces, such as autoclave liners, etc., be leaded by rotating the pieces rapidly and then pouring in the lead. All the pores of the metal are thus completely sealed, and pieces up to 6000 liters and 10 tons in size can be treated in this way. The iron or copper must be tinned before being leaded or the coating does not adhere well. The lead coatings are often quite thick, up to 2 mm. or more, and the amount of lead used in a large apparatus may thus weigh thousands of kilograms.

This brief treatment, of course, in no way covers adequately the use of metals in the dye industry, but it may suffice to show the great importance that materials of construction have in this field.

2. Nonmetals

The most important of the nonmetal materials of construction are the cements and the stoneware products.

Stoneware is the one usable material which has complete resistance to acids. To be sure, lead may be used in its stead in certain cases, but every plant chemist has found that even the most carefully leaded apparatus will require, in due course, expensive repairs. If a piece of equipment must give uninterrupted service for an unlimited period, only stoneware can be used, or in a few cases, acid-resistant stone such as Volviclava, Granazit, or Bingersandstein.

Stoneware stopcocks of small sizes are widely used and last indefinitely if properly handled. Hot liquids are injurious to them because of the danger of cracking, and proper lubrication must be used to prevent freezing. So-called reinforced stoneware stopcocks, which are more resistant to shock and also to heat, have a protective housing made of leaded sheet iron. They have entirely replaced the older hard lead (anti-mony-lead) type. Stoneware is also used for supply lines, valves, and centrifuges. The basket of a stoneware centrifuge is placed in a steel bas-

ket in such a way that it is not thrown out by centrifugal force. Very complicated constructions are used, but these cannot be gone into here.

Stoneware reservoirs find wide use. They are prepared either in one piece or by joining several pieces together. Vessels having capacities up to 5000 liters can be prepared, but they are expensive and very sensitive to small temperature variations. Acid-resistant reservoirs can also be prepared in the plant by a good mason. An iron vessel is layered with cement, and acid-resistant bricks or glazed stoneware tile are laid over the hardened cement using ordinary cement mortar. The individual tiles are separated by about 6 mm., and the joints are filled with acid-resistant cement which is supplied in high quality by various companies. First, the joints are half filled with the cement and dried by heating the whole apparatus with steam coils for perhaps 14 days. When this first layer of cement is dry, the joints are completely filled and the drying process is repeated. Lining a 5000-liter vessel in this way takes about 2 months. When the mortar has set, the vessel is filled with 2 per cent sulfuric acid and is allowed to stand for 3 days. This treatment hardens the acid-resistant cement and at the same time tests the joints for leaks. Vessels lined in this way, if carefully made, resist even hot 80 per cent sulfuric acid and can be used under pressure or vacuum. Vessels can also be lined with two layers of acid-proof tile laid in such a way that the second layer of tile covers the joints in the first layer. These installations, however, are very costly and are little more resistant than those properly lined with a single layer.

Alkaline and neutral liquids can be kept in concrete reservoirs which are usually reinforced with iron. The reinforcement must be calculated very carefully, because large stresses are created when such a reservoir is warmed. Concrete vats are also used in dye manufacture, but it is advisable to line them with acid-resistant tile, since even very weak acid corrodes concrete very rapidly. Stirrers can also be made of concrete and can be used to good advantage in special cases.

The floors in manufacturing areas should be covered with acid-proof slabs and the cracks filled in with sulfur which adheres to the stone and is not washed away by hot water the way asphalt is. Good cement floors are suitable in areas where the floors remain dry.

Glass finds only limited application because of its fragility, but there are many times when it must be used. It is indispensable, for example, in chlorination reactions at elevated temperatures (see dichlorobenzaldehyde). Chlorine lines are frequently made of glass, and stirrers consisting of glass rods attached to iron or wood shafts are widely used.

Fused quartz is used very little, although quartz lamps are used to an increasing extent in chlorinations.

Porcelain is used only in the laboratory and dye house. The highly praised hard glass vessels would be recommended except that they frequently shatter.

Enamel is a special form of glass, used particularly for covering cast iron. The preparation of a good, acid-proof enamel is difficult, and a double coating is often used on manufacturing equipment. The enamel used is not as attractive as that used on household articles, but is much more resistant. An enameled apparatus with a defect in only one spot must almost always be removed, and, therefore, extreme care is required in its use. Metal stirrers are never used in enameled vessels — only wood is used. Very complicated enameled equipment is made and is very expensive. Enameled ladles are widely used.

3. Materials of Organic Origin

Wood assumes first place among the natural materials. It is used in making vats for dye manufacture, for stirring equipment, for framework, and particularly for the construction of factory buildings. In recent years, a trend has started toward the use of reinforced concrete for buildings in place of wood, and it remains to be seen how they will stand up. Wood is surprisingly resistant to all chemicals since it is attacked only on the surface, and the degraded surface layer then acts as a protective film for the interior.

American pitchpine, Scotch pine, and larch are used predominantly. Birch cannot be used because of its tendency to split, but oak, which is costly but very resistant, is often used. Other woods, except for ash, are not considered because they are too expensive.

Vats up to 20,000 liters in size are used, with stirrers made of ash and attached to the driving assembly by means of a chuck. Such large vats are rarely placed on a framework, as shown in Figure 56, but usually rest directly on the floor. A vat which is to be evacuated must be braced internally with beams, and one to withstand 2 to 3 atmospheres of pressure must be held together with strong iron rods (so-called tie rods). A very small air tube is always installed next to the syphon tube so that any precipitated dye can be stirred up with compressed air. If this precautionary measure is not taken, a large part of the dye may be left behind on the bottom of the vat. All iron hoops should be painted with red lead; frequently, the whole vat is painted. If the liquid in the vat is to be heated to boiling, the vat should be covered, for the sake of

convenience and safety, and a suitable flue for steam is necessary. Figure 56, page 376, shows this arrangement clearly. Vapor stacks are provided with an air or steam tube so that a strong draft can be produced.

Wood is often used for filter press frames; larch or oak, instead of pitchpine, which is rich in tar, is used for presses which are to be used with alcoholic liquids. Also, small spigots made of pear wood are used on filter presses.

Leather is used for transmission belts, for pump leathers on hydraulic presses, and for other minor purposes.

Rubber is the outstanding artificial organic material used for construction purposes. It is used in many forms, such as tubing, coatings on centrifuges (hard rubber), scoops, and hard rubber stopcocks. Rubber coatings on centrifuges have proven very satisfactory, but are not used widely in the dye industry except for centrifuging gallic acid. With this compound, however, copper centrifuge baskets can be used, or iron baskets lead coated by the Schoop spraying process. Chlorinated rubber, and synthetic chlororubbers, such as neoprene, are used as acid-resistant coatings for supply lines, vessels, etc.

Synthetic resins, such as Bakelite, Pollapas, Cibanite, and similar materials, are used only for special purposes, since their mechanical strength is generally quite low. Hard rubber is a better material, and can be used also for concentrated hydrochloric acid lines.

Filter cloths are made from organic materials including cotton, jute, hemp, and wool. Press cloths are made from cotton, rarely wool. Strongly acid precipitates are pressed out in camel hair cloths. At one time, cloths made from Chinese hair were available on the market and were superior to all others for durability. As filter cloths, but not press cloths, the so-called nitro filters are often used. (Nitro filters have only moderate mechanical strength.) These are prepared by nitrating special cotton filters. Since cotton shrinks on nitration, the warp and weft of the material must be equally strong. The dry cotton material is stretched lightly on an aluminum frame and suspended for 1 hour in 85 to 88 per cent nitric acid at 15–20°C., and then for 20 minutes in sulfuric acid (66° Bé), after which it is washed thoroughly. These filters withstand 60 per cent sulfuric acid at 100°, but they are immediately destroyed by acid solutions of iron salts. Polyvinyl chloride filters have recently been introduced. They are characterized by exceptional resistance and strength, and are very stable to acids. Glass filter cloths are also used, they too being stable to acids.

O. TECHNICAL DETAILS OF FACTORY MANAGEMENT

The money value of world dye production is actually extremely small, corresponding in 1913 (500 million francs) to less than one-tenth of the value of wool production, less than one-fifth of cotton production, and about one-fifth of rubber production. Dye manufacturing was a highly competitive business, requiring expensive factories, and the energy, intelligence, and perseverance put into this industry is without parallel.

The development of the dye industry had the result that many closely guarded secrets were made available for the general good of the various interests. Ulmann's great encyclopedia of technical science has shown that many of the processes have been known for a long time by a majority of the manufacturers. Also, the freedom of workers to move from place to place had the result that every important improvement became known, in a relatively short time, to all competitors. The success of the large dye firms is not based on secret processes, therefore, but depends on long tradition, good organization, and specialties protected by patent.

It would be a grave error to believe that specialties alone could keep a dye plant in business although this view has been stated not only by young, inexperienced chemists, but by established technical and business people. Specialties are, in most cases, only profitable additions to the line of regular products, and in order for a firm to attain a large size at all, it must produce the large-volume items. Chief among such large-volume, staple articles are the blue-blacks, such as direct deep black EW, for example, chrome blacks of various composition, such as diamond black PV, eriochrome black T, etc. After the black dyes, which make up more than 50 per cent of the total demand, come the blue dyes, chief among which are indigo, indanthrene, direct blue, and sulphur blue. Next are the red dyes and finally the yellows such as chryso-phenine and naphthamine yellow NN.

These mass production articles enable the manufacturer to carry his specialties to the public, and, on the other hand, to keep his general factory costs at a minimum. It has been pointed out repeatedly how important it is in the preparations of intermediates to recover all by-products. With this in mind, the different dye manufacturers have formed combined interests in order to work out production costs of the more important intermediates to their mutual benefit, and to share

their experience in manufacturing operations. This concentration makes it possible to prepare each intermediate on a very large scale and to recover all by-products, such as nitrous and sulfurous acids, hydrogen sulfide, thiosulfate, and Glauber salt. Such a combine must, of course, also manufacture the necessary inorganic intermediates so that it has an independent supply of caustic soda, sulfuric acid, hydrochloric acid, soda, chlorine, and, if possible, also common salt and coal.

The arrangement of a dye plant must be modern; the greatest mistake, which unfortunately often appears, lies in the use of old, inefficient apparatus. Sometimes it is necessary to change a plant overnight for a new process, and it is the duty of the plant manager to provide the most suitable equipment. A thoroughgoing alteration is almost always less expensive than the continued use of an impractical arrangement requiring many workers and much space. It generally turns out that such an alteration, irrespective of cost, is actually the cheapest way out. Estimates are made by the accounting department, based on facts supplied by the engineer and plant chemist.

In order that a plant of so complicated a nature as a dye factory may function correctly, it must be well organized. The management is always composed of business men and chemists, operating in their own spheres, but remaining in contact on all questions. An intermediate group has the responsibility of arranging current affairs, such as reclamation, investigation of new and foreign dyes, preparation of pattern cards, etc.

The position of the chemist in the dye factory is quite different depending on whether he is employed in the dye house, the research laboratory, the plant, the patent department, or elsewhere. The duties of the research chemist consist in working on new and scientific problems, with constant reference to the literature. It might be emphasized that it is senseless to attack any problem before obtaining all available published information about it. Well run dye factories, therefore, have a literary division which collects all the references, on request, from a carefully prepared index, thus providing a rapid and complete survey of the literature. Frequently, it is necessary to extend a certain reaction to several fields and to prepare, systematically, hundreds of dye and other compounds because it is known that only a very few of the compounds, at the most, will have any value (Ehrlich 606). After the management, in combination with the various subdivisions such as the dye house, pharmaceutical laboratory, or other departments, finds a new compound or a new process sufficiently interesting, larger scale tests must usually be carried out. These are conducted in the

industrial division, a connecting link between laboratory and plant, using apparatus which is larger than that in the laboratory but much smaller than plant equipment. These tests give an indication of how the reaction will probably behave in large scale operation, and often save large sums of money.

At this stage it is also decided whether a patent application should be filed on the reaction or compound. It is the duty of the patent department to decide whether patent protection can probably be obtained, or whether it appears best to keep the observation secret until the whole field has been investigated so that there will be no possibility of avoiding the patent when it is granted. Only in rare cases is it decided to attempt keeping a discovery secret. This is an unsafe practice, and therefore is resorted to only in necessary cases.

The chemist is obliged to submit to the management at regular intervals a report on his activities so that the management is completely informed of current happenings. These reports are submitted once a month, or at longer, but regular, intervals, and are prepared under the supervision of the laboratory director.

Before a product goes into plant production, it is submitted for cost analysis by the accounting department. The necessary data are supplied by the laboratory director and the plant engineer. An example is given later in Section P, showing how the price of a dye is arrived at.

The plant proper is divided into three sections: chemical-technical, analytical and dyeing, and engineering.

The corrosive action of chemicals results in rather rapid destruction of apparatus, and furthermore, changes are frequently necessary, so that the ratio of chemical workers to hand workers (locksmiths, tube makers, cabinet makers, painters, masons, etc.) remains at about 2 to 1. Chief among the workshops are the repair shops which are under the direction of the plant engineer. Repairs, or a change in the arrangement of the equipment, are carried out under the direction of the plant chemist, with approval of the management, or if gross alterations are involved, under the supervision of the engineer. All work orders are entered on forms which go to the accounting division when the work is completed.

Large dye plants have their own construction shops, but even these have large pieces made by outside machine firms with whom agreements are made as to price and delivery. It is desirable to use as few different models as possible so that replacements can be made from stock. In this way, few replacement parts need be stocked for several apparatus if the parts are interchangeable.

Charges. Besides the costs associated with wearing out and replacing equipment, other plant costs of various kinds must be considered. Some of these are accurately determined, and some of them are lumped together and calculated as general costs. Wages are among the costs which can be determined relatively easily, being calculated on the basis of work sheets and records of the plant chemist. Further, steam consumption is calculated from the readings of regular steam gauges, as are also compressed air and vacuum.

Steam Consumption. The steam consumption in a dye plant is an important factor, large quantities being used, especially in the evaporation of reduction reaction mixtures. Multiple evaporators (double and triple stage) are coming into increasing use. In this kind of apparatus, the steam is used two or three times by passing the exhaust steam from one vessel into a second vessel where it evaporates a further quantity of liquid under reduced pressure. These apparatus are modeled in part after the multiple evaporators of the sugar beet industry, except that here the liquid to be evaporated is circulated rapidly from a heating vessel through a tube evaporator. One advantage lies in the fact that the boiler scale (mostly gypsum) is deposited solely in the side-vessel in which the tubes can be replaced in a few hours. Fuel consumption is reduced very considerably by this multiple use of the steam, and the large dye plants now use triple-stage evaporators almost exclusively. The use of steam is carried still further by heating the steam originally to 60 to 100 atmospheres pressure instead of only 5. This high pressure steam is used to drive a steam turbine, and the exhaust steam, at about 5 atmospheres, is lead into the plant lines. The pressure drop from 60 or 100 atmospheres to 5 yields so much energy that the dye plant may even produce an excess of electrical power. It has been proposed to reduce the steam pressure to only 2 atmospheres, but then conduction of the steam is difficult if excessive losses by radiation are to be avoided, particularly in winter. More recently, a new method has been introduced for better utilization of steam, although the principles upon which the method is based are quite old. The steam from the evaporating liquid is drawn out from the hermetically sealed evaporator by a turbo-blower and led under a pressure of about $\frac{1}{4}$ atmosphere into a tube system built into the same vessel. Compression of the steam results in significant heating, and up to 80 per cent of the fuel may be saved. Apparatus of this type is apparently being adopted rapidly, and deserves the most serious consideration for use under the conditions prevailing in Switzerland.

Compressed Air and Vacuum. The amount of compressed air required must also be considered along with the quantity of steam. Air is usually employed at a pressure of 2 to 3 atmospheres, obtained with either reciprocating or rotatory pumps. The amount required depends chiefly on the number of filter presses in use, since these use air for the most part. Every precipitate, before being removed from the press, is subjected to a stream of air for some time to blow out most of the mother liquor. One press having 40 chambers uses, for example, up to 100 cubic meters of air (at 2 atmospheres) per hour, costing 3 to 5 rappen depending on the unit cost.

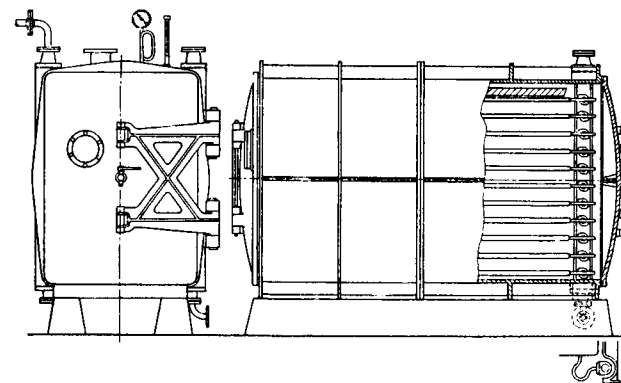

Fig. 52. Vacuum drying oven for dyes.

Thus, the air cost for a dye plant is an important factor and must be calculated exactly. The compressor-vacuum pump shown in Figure 39 has proved very satisfactory (see also page 344).

The cost of water must also be determined accurately, since large amounts of it are used, especially as cooling water for condensers.

Function of the Plant Chemist. The work of the plant chemist is among the most interesting in the whole industry because the chemical reactions do not permit of simple control and must be followed closely and often be corrected. The chemist should always be alert and he should know each step in the manufacture in detail.

Manufacturing. The necessary raw materials are ordered a day or so in advance on order forms which are sent to the store room or, in some cases, to another plant. The chemicals are brought to the manufacturing section on the evening before they are to be used so that all of the materials are at hand when the process is begun. The chemist is responsible for seeing that the products are dry. Since many dyes are sensitive

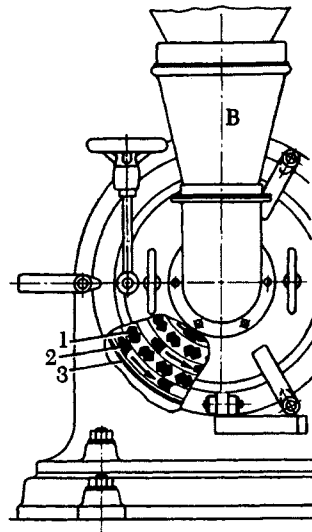

Fig. 53. Sketch of the "Perplex" disintegrator: (B) feed; (1) stationary hammers; (2) rotating hammers, 1200-2000 r.p.m.; (3) sieve.

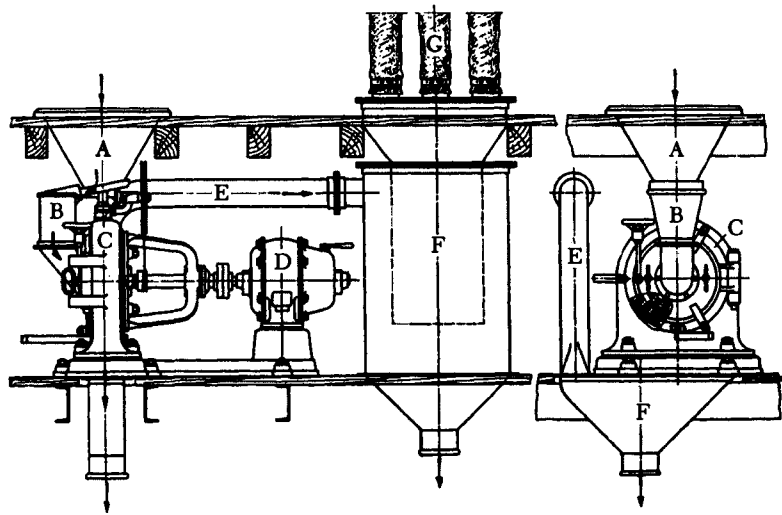

Fig. 54. Disintegrator for dyes: (A) feed hopper; (B) oscillating feed with magnetic screening device; (C) disintegrator; (D) motor; (E) dust pipe; (F) dust chamber; (G) filter bags.

to higher temperature and therefore require careful handling, the driers should be carefully supervised by the chemist who is always aware of the effect of drying on the color strength and tint of a dye. Representative cases have been mentioned in connection with methylene green and azo yellow.

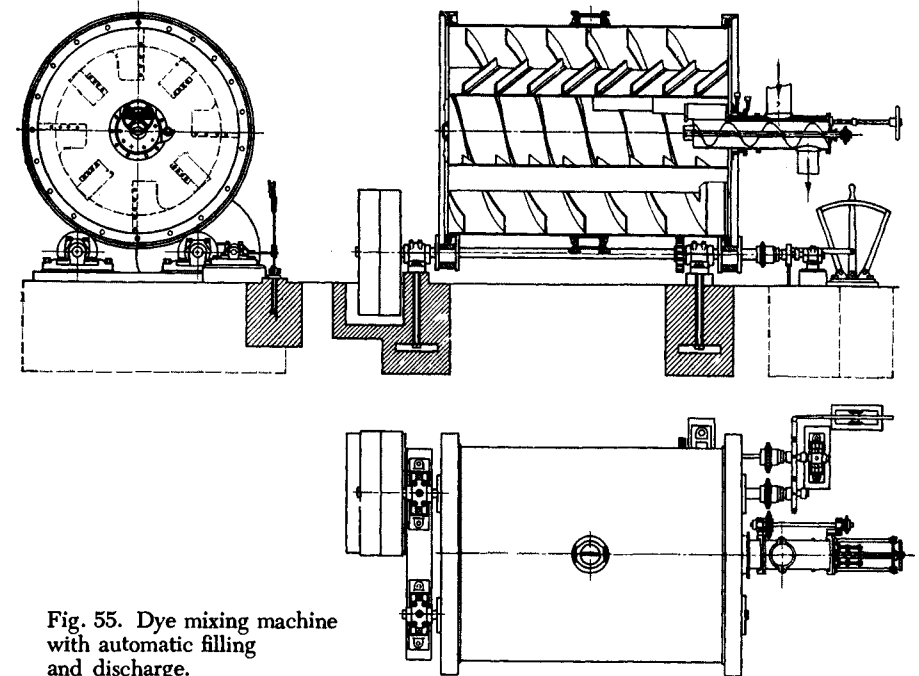

Fig. 55. Dye mixing machine with automatic filling and discharge.

Sample Dyeing. The finished dye goes directly from the driers to the dye house where a small representative sample is tested against the standard. The results are reported immediately to the management, the accounting department, and the chemist so that everyone is kept informed of the progress of the process. Frequently, a dyeing test is made with a small sample removed when the filter press is emptied so that any possible errors can be discovered at that stage.

Drying in recent years has been carried out to an increasing extent in vacuum drying ovens since it has been shown that this system uses less steam and leads to products of greater strength. Figure 52 shows a modern vacuum drying oven, many models of which are in use. Stable intermediates, such as sodium β -naphthalenesulfonate and simple azo dyes, can also be dried on simple steam plates or in drying tunnels using the counter-current principle. Even with these systems, however, va-

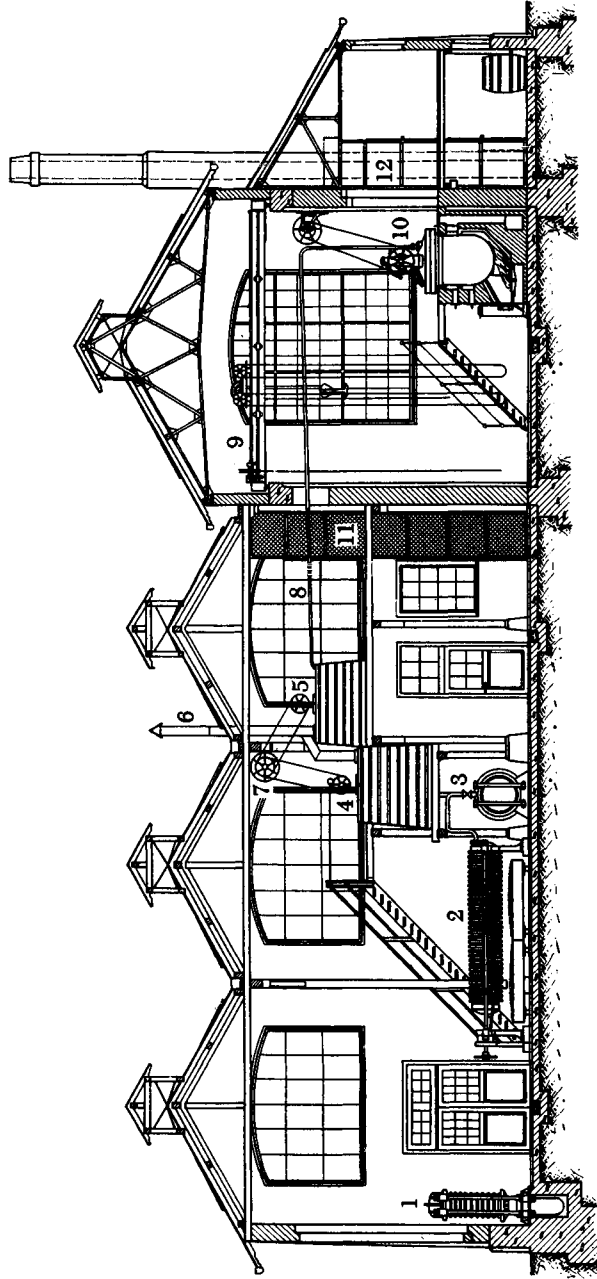

Fig. 56. Manufacturing area of a dye plant: 1, hydraulic press; 2, filter press with wooden troughs for the filter cake; 3, pressure vessel, reinforced with iron; 4, 5, wooden vats with mechanical stirrers; 6, flue with forced draft; 7, power shaft; 8, blow-off line from autoclaves; 9, traveling crane (10 ton); 10, autoclave, 1.5 cubic meter capacity; 11, 12, freight elevators (3 ton).

vacuum drying is being used more and more since it saves both time and space. About 6 to 6.5 kilograms of steam are required to dry 1 kilogram of a dye in a vacuum drying oven, whereas 9 kilograms are needed in a tunnel kiln without vacuum.

A product, to be dried rapidly, must be broken up at least once during drying. Since considerable dust is formed in this operation, the drying room is often provided with dust removing equipment.

The vapors from the drying ovens are condensed in moisture condensers so that the pumps are not exposed to acid or alkaline fumes.

When a number of batches of a dye have been dried, they are ground up and adjusted to a desired standard strength. The grinding and mixing is usually carried out in a separate blending plant which is under the direction of the factory dye house.

Grinding. The dyes are ground in modern disintegrators such as the one shown schematically in Figures 53 and 54. The efficiency of these machines exceeds by 10 to 15 times that of the old edge mills or grinding drums with steel balls, and in addition, they give much smaller particle size. Many rejections of a product because of insufficient solubility are the result of improper grinding since the older apparatus often press the material together in very hard, slate-like tablets which dissolve with difficulty.

Whenever possible, approximately the necessary quantity of diluent is milled together with the dye so that the milling time is shortened. The concentrated dye is mixed with the diluent (Glauber salt, common salt, soda, dextrin, etc.) and the mixture is then put through the mill. The mill pictured gives automatic screening and has a magnet for removing iron particles which are always present in a product. The dye is crushed by hammers of a special type and whirled around until it passes through the screen (Fig. 53). Air is drawn into the apparatus by centrifugal action and must be permitted to escape. Tubular filter bags (*G*) permit the air to escape but retain all the dust. Most of the dust, however, is caught in the air chamber (*F*) into which the air stream is directed tangentially to the chamber wall. If very soft materials, such as β -naphthol or naphthalene are to be ground, it is better to remove the screen because it clogs so easily. The material is carried by a short screw conveyor directly into the mixing drum where it is mixed for several hours. Figure 55 shows a modern mixing drum equipped with a reversible spiral gear which permits automatic filling and emptying. Such apparatus is designed to handle quantities up to 4000 kilograms and is gradually replacing the old, uneconomical mix-

ing equipment, especially for use with large-volume preparations. Use is also made of simpler mixing apparatus operated with compressed air or vacuum. Some dyes must be pulverized outside of the grinding room, either because they are inflammable or because they are unpleasant to handle (Bengal blue or methylene blue, page 311).

After the dye house has found a dye correct for tint and color strength, the dye goes to the package store from which it is withdrawn for the market. The management, accounting department, and plant chemist are informed and attention is directed to any special facts, such as good or bad yield and tint, etc. When these data are filed on a product, either a dye or an intermediate, the function of the industrial chemist comes to an end.

P. CALCULATION OF COSTS FOR A SIMPLE DYE

The costs and prices assumed for this calculation approximate the figures prevailing in 1913-1914 in a country with its own coal supply. The example is given solely to show the beginner how the cost price of a relatively simple azo dye is arrived at from many separate items. Appreciably higher prices prevailed in Switzerland in 1913, however.

Orange II or Acid Orange A (Sulfanilic acid- β -naphthol, see page 262)

The cost analysis of a product in the dye industry is always made by the accounting department which receives, from the various plants, daily, weekly, or monthly reports containing the data necessary for accurate calculation of costs. The accountant holds a confidential position and is one of the key men in the dye factory.

The cost of a product is made up of the material cost and wages. No other factors contribute. Each sum involved in the cost must be based on accurate data.

The costs of the separate components are calculated first.

β -Naphthol

(a) Sodium β -naphthalenesulfonate

Components	Cost per 100 kg.	Total Cost
260 kg. naphthalene	11.00 frs.	28.60 frs.
280 kg. sulfuric acid	2.70	7.56
60 kg. soda	9.00	5.40
60 kg. coal	2.00	1.20
350 kg. salt	1.40	4.90
Total		47.66

The yield of sodium naphthalenesulfonate is 165 per cent, or 429 kilograms, costing 47.66 frs. Hence, 100 kilograms costs 11.10 frs.

This cost is the raw material cost, or Cost I, including only the costs of materials purchased or received from other plants (sulfuric acid from the acid plant, etc.). To this value is now added a whole series of charges of varying nature which include wages, repair and depreciation of apparatus, press cloths, drying, transportation charges, milling, power, steam and water. All of these charges must be determined accurately if a correct final value is to be obtained. Obviously, this work must be done by trained personnel.

The wages are determined from the time sheets of the workers which are checked by the factory foreman. The plant chemist should concern himself as little as possible with these administrative details, since they interfere with the chemical matters for which he is responsible. He keeps the chemical records and once a week, at least, the records are turned in, over his signature, to the accounting department.

Other partial costs include maintenance of the store room, the repair shops, and the estimates from the plant engineer. Tests are made from time to time to determine the exact amount of steam and water used for a given product.

These charges can be distributed among the individual products in various ways. For simplicity, we have based our values on units of 100 kilograms of dry material.

Assume that the various charges for the dry sulfonate are calculated to be as follows:

Wages, 2 hours at 0.80 frs. per 100 kg. (insurance and benefits included)	1.60 frs.
Power, 4 K.W.H. at 4 cts. (pressing, stirring, compressed air included)	0.16
Drying and grinding, 20 cts. per 100 kg.	0.20
Total charges for 100 kg. of sulfonate	1.96
Raw material cost for 100 kg.	11.10
Total	13.06

(b) Fusion of the Sodium Salt

We assume that 100 kilograms is fused, but note that actually much larger quantities are used (400 to 2000 kilograms). Our assumption leads to the following calculation:

100 kg. sulfonate	13.06 frs.
45 kg. NaOH at 17.00 frs. per 100 kg.	7.65
15 kg. coal at 2.00 frs. per 100 kg.	0.30
20 kg. sulfuric acid at 2.70 frs. per 100 kg.	0.54
Labor for fusion, dissolving, and distillation	5.00
Fuel for fusion and distillation, cooling water and compressed air	2.00
Amortization (5.00 frs. per 100 kg.; yield 45 kg.)	2.25
Total	30.80
Deduct for recovered sulfite and Glauber salt	2.00 frs.
45 kg. yield of pure naphthol costs, therefore	28.80 frs.

Hence, 1 kilogram of pure naphthol costs 64 cts.

To this figure is now added the general charges which can be placed at 5 per cent, making the cost price of the naphthol, in round numbers, 67 cts. per kilogram.

In Switzerland, it is quite impossible to achieve this low cost, since coal and other starting materials are so much more expensive. At least twice the above cost would be expected.

Sulfanilic Acid

(a) Nitrobenzene

100 kg. benzene at 32 cts. per kg.	32.00 frs.
110 kg. 75 per cent HNO ₃ at 40 cts. per kg.	44.00
170 kg. H ₂ SO ₄ at 2.70 frs. per 100 kg.	4.60
Total	80.60

Yield: 154 kg.

Repairs and depreciation, 50 cts. per 100 kg.	0.77
Labor, 35 cts. per 100 kg.	0.54
Total for 154 kg. nitrobenzene	81.91
Less 3 frs. for recovered spent acid	78.91

Hence, 1 kilogram of nitrobenzene, including general charges, costs about 55 cts. (In very large plants, the cost is still less, often below 50 cts.)

(b) Reduction of Nitrobenzene

Assuming that the 154 kilograms of nitrobenzene is reduced, even though in practice up to 2000-kilogram batches are run:

154 kg. nitrobenzene (rounded off)	85.00 frs.
200 kg. iron at 3 cts. per kg.	6.00
20 kg. hydrochloric acid at 4 cts. per kg.	0.80
8 kg. lime at 1.25 frs. per 100 kg.	0.10
Steam, repairs, depreciation, power, etc.	5.00
Total	96.90

Yield: 110 kg. Price per kg., including general charges, in round figures, 95 cts.

(c) Sulfonation of Aniline

100 kg. sulfuric acid at 2.70 frs. per 100 kg.	2.97 frs.
93 kg. aniline at 95 cts. per kg.	88.35
	91.32
Labor, 5 hours at 80 cts.	4.00
Steam (baking oven), coal	2.50
Depreciation, 10 cts. per 100 kg. crude product	0.17
Total	97.99

Yield: about 163 kg. of 100 per cent sulfanilic acid. Cost per kg., including general charges: about 65 cts.

The costs of the two crude intermediates have now been calculated. These values, of course, are entirely dependent on the particular circumstances and serve only to show how intricate a process it is to determine exact values.

In our example, we assume that the sulfanilic acid costs 65 cts., and the β -naphthol, 67 cts.

Preparation of the Dye from Sulfanilic Acid and β -Naphthol

We shall start out with 1 kilogram-mole, multiplying the quantities given on page 262 by 10,000.

173 kg. sulfanilic acid at 65 cts. per kg.	112.45 frs.
60 kg. soda at 7 cts. per kg. (In Switzerland, 10 cts.)	4.20
144 kg. β -naphthol at 67 cts. per kg.	96.48
144 kg. caustic soda (30° Bé) at 6 frs. per 100 kg.	8.64
110 kg. sulfuric acid at 2.70 frs. per 100 kg.	
(in Switzerland, 4.00)	2.97
70 kg. sodium nitrite at 51 frs. per 100 kg.	35.70
250 kg. soda at 7 cts. per kg.	17.50
800 kg. ice at 80 cts. per 100 kg.	6.40
200 kg. salt at 1.40 frs. per 100 kg.	
(In Switzerland, about 3.50)	2.80
Total	287.14

Yield: about 400 kg. concentrated material which is contaminated with salt and soda.

Labor, 12 hours at 80 cts.	9.60 frs.
Charges against the dry, concentrated product	
Drying of 400 kg. at 8 frs. per 100 kg.	32.00
Mixing and grinding	16.00
Air, steam, water, and power	16.00
Total	73.60

The dye house costs are either charged to the plant or added to the general charges. The charges for advertising cannot properly be included here in the manufacturing costs. The testing costs are taken as 1.80 frs. per 100 kilograms of final product, or 7.20 frs.

Testing charges	7.20 frs.
Special charges	73.60
Combined charges, without general factory charges	80.80
Cost, without general factory charges, for 400 kg. acid orange A	287.14
Total cost	367.94

To this cost must be added an amount making up the so-called general factory charges. These include the following items: freight, yard labor, storage, watchmen, etc. To these are almost always added the costs of the analytical and plant laboratories without including salaries of technical personnel. The total of these charges are subject to great variations depending on the size of the business. It can be assumed, however, that these general factory charges will amount to between 5 and 7 per cent of the value of the final product. Certain highly competitive products are usually assigned lower charges, based on decisions of top management.

Assuming a figure of 6 per cent for the general charges, and adding this to the 367.94 frs., we arrive at the actual cost price II, 390.02 frs. for 400 kilograms of pure product, or about 0.98 fr. per kilogram. The pure material is brought to the desired strength by the addition of salt, as mentioned on page 377.

IV. Analytical Section

Accurate analytical determination of starting materials is essential in the dye industry. The methods which are used are partly physical, partly chemical. With many products, only physical data, such as melting point, freezing point, and boiling point, are determined. Thus, aniline, toluidine, nitro compounds, and many others, are characterized solely by these measurements. In some cases, the specific gravity (density) and even the refractive index to monochromatic light are determined. All the important methods are given in the valuable work of Lunge (*Untersuchungsmethoden*). The specifications are often established by agreement and variations from them serve for guidance. Today, intermediates are marketed in such high purity that no reasonable demands are unfulfilled.

Test samples of materials which are purchased should be investigated without delay in the analytical laboratory. The sampling is frequently specified in the purchase contract, as are the methods of heating to be used in melting point and freezing point determinations. Materials prepared in the plant are frequently used in technical solutions whose content of active material is determined by analysis. The large firms are going over more and more to the practice of weighing out their solutions directly into the reaction vessels, using balances with a total capacity of up to 40,000 kilograms and a sensitivity of 100 grams.

The molecular weight, calculated from the chemical formula, is given as a characteristic for each product in the dye industry. Now, many substances are used in different forms, e.g., benzidine as the sulfate and as the free base, and Cleve acids as the free acids and as the sodium salts. It is agreed, therefore, always to take the same value for molecular weight, whereby, of course, a salt comes out with a lower purity than the free acid. The molecular weight of any material purchased is always specified along with the price per kilogram of pure material. For example, if 1 kilogram of benzidine (mol. wt. 184) costs 3 frs., and 1 kilogram of benzidine sulfate (mol. wt. 282) costs 2 frs.,

then the pure base in benzidine sulfate costs 2 x 282/184 or 3.02 frs. The cost of the base is therefore identical in the two products. In the above example, the sulfate would be 65.2 per cent pure (mol. wt. 184), and to obtain 184 kilograms of benzidine base, 282 kilograms of the sulfate would have to be used.

Preparation of Standard Titrimetric Substances

The determination of sodium nitrite is done by the well known oxidation method with potassium permanganate. This procedure, however, always gives too high values for the plant chemist since the permanganate oxidizes any other oxidizable material which may be present in the nitrite. Despite this disadvantage, the method is used in nitrite plants. Only one other method is available to the dye chemist, namely, the sulfanilic acid method which, with practice, can be made to give accurate results.

Preparation of Pure Sulfanilic Acid

A strongly alkaline solution of 250 grams of technical sulfanilic acid in about 1 liter soda solution is boiled until all of the aniline has been driven off. The solution is then filtered and made strongly acid with hydrochloric acid. The precipitated material is filtered off after 12 hours, washed with a small amount of water, and redissolved in 400 cc. water containing enough soda ash (about 60 grams) to make the solution neutral. The hot solution is cooled to 0°C. with stirring, and the precipitate of sodium sulfanilate is filtered off. If the apparatus is available, the mother liquor is removed by centrifuging. The crystals are dissolved in 500 cc. distilled water, and the solution is filtered and acidified with pure hydrochloric acid (concd.). The solution is stirred so that only small crystals are formed. The precipitate is filtered off after a day and washed carefully with distilled water to wash out all of the sodium chloride. The material is then recrystallized once from hot distilled water and dried at 120° to constant weight. The purified material is stored in a tight glass bottle with ground glass stopper. It is almost white and contains less than 0.01 per cent of impurities. A solution of the reagent is prepared by dissolving 173 grams in 100 cc. pure ammonia (20 per cent NH_3) and diluting to 1 liter at 17.5°. This solution is stable in the dark for many months, but should be checked at intervals of 3 months. This standard solution is used in the preparation of 1 N nitrite solution.

Preparation of 1 N Sodium Nitrite Solution

A solution of 75 grams of technical sodium nitrite in a small volume of water is filtered and made up to 1 liter at 17.5°C. This solution is used to titrate 50 cc. 1 N sulfanilic acid solution, as follows:

The sulfanilic acid solution is pipetted into a 500-cc. beaker, diluted with 200 cc. ice water, and acidified with 25 cc. concentrated hydrochloric acid. The nitrite solution is added from a burette whose tip extends beneath the surface of the liquid. After 45 cc. has been added, the addition is continued dropwise until a drop of the mixture on starch-iodide paper produces an *immediate*, very weak, but permanent blue coloration. This test must be made by *spotting* (not rubbing) the starch-iodide paper. The whole diazotization takes about 10 minutes. From the volume of nitrite solution used, it can be calculated how much water must be added to make the solution exactly 1 N. The solution should always be diluted to 1 N strength instead of using it as it comes out, since the use of a factor in all subsequent calculations involves too much work.

After the sulfanilic acid and nitrite solutions have been standardized, a 1 N aniline solution is prepared. Pure aniline (200 cc.) is distilled from a small distillation flask (Fig. 7, page 71) at such a rate that the distillation is complete in 45 minutes. The aniline which comes over within a range of one-half degree between 184 and 185°C. is used for preparing the solution. The specific gravity should be 1.0260 to 1.0265 at 17.5°.

93 grams of the pure aniline is dissolved in 150 cc. pure 30 per cent hydrochloric acid and the solution is made up to 1 liter at 17.5°C.

If the nitrite and sulfanilic acid solutions have been prepared correctly, 100 cc. of either the sulfanilic acid or the aniline solution should require exactly 100 cc. of the nitrite solution.

Preparation of 0.1 N Phenyl Diazonium Solution

50 cc. of the aniline solution is measured out and mixed with 50 cc. concentrated hydrochloric acid. The mixture is cooled by placing the measuring flask in ice water, and 50 cc. 1 N nitrite solution is added while the mixture is swirled to provide agitation. The solution is kept in ice water for 20 minutes after which it should show only the slightest reaction for nitrous acid. Ice water is added to make the volume up to 500 cc. and the solution is ready for use. Under no circumstances must the diazotization be carried out in less than 20 minutes, since the reaction takes this long under the conditions employed. The diazo solution can

be held unchanged for about 4 hours at 0°C. in the dark, and must always be freshly prepared.

Determination of Amines

(a) Direct Determination

The amine is titrated with hydrochloric acid and sodium nitrite in very dilute solution, and the resulting diazonium salt is coupled with an accurately known amount of a phenol, usually Schaeffer salt. With other compounds, such as H acid, amino R acid, etc., one sample is diazotized and another is coupled with diazotized aniline or other amine. Under some circumstances it is possible to determine two substances in mixture if one of them reacts much more rapidly than the other. Thus, with a little practice, one can determine quite accurately both G salt and R salt in mixtures of the two. R salt couples very rapidly with diazotized aniline producing a red dye, while G salt couples more slowly and gives a yellow dye. A large number of other special methods are available which permit the determination of the individual constituents in mixtures.

Diazonium compounds other than phenyldiazonium chloride are also used, but to a smaller extent. Thus, in some plants, diazotized *m*-xylydine is used, but this appears to have no advantage since the diazonium solution is less stable. Diazotized *p*-aminoacetanilide, on the other hand, is used in certain cases because it couples more vigorously and gives a very stable solution (see chromotropic acid). *o*- and *p*-Nitroaniline are used less frequently.

For each gram of nitrite, 5 grams of soda ash or, if coupling is carried out in acetic acid solution, at least 15 grams of sodium acetate, is used. Nitroaniline requires double these amounts, and still more is required if the substance contains a sulfo group. Coupling should be carried out below 5°C. and the solution must be very dilute (about 1 per cent).

The excess of diazonium salt is determined by spot-testing on filter paper, after first salting out any easily soluble dyes. Easily coupling amines or phenols, such as resorcinol, R salt, or H acid, are used as coupling reagents. Some laboratories use a fresh hydrocyanic acid solution which gives a yellow color. An excess of phenol or amine is determined simply by spot-testing on filter paper with the diazonium solution — this procedure involving only negligible losses.

(b) Indirect Determination

Many amines cannot be analyzed directly by diazotization, either because they form diazoamino compounds or because they give diazonium compounds which color starch-iodide paper just as free nitrous acid does. These amines, exemplified by the nitroanilines, dichloroanilines, etc. must be determined indirectly.

The amine (0.01 mole, for example) is dissolved in concentrated or partially diluted acid, and the solution, after dilution with water and ice, is diazotized with an appreciable excess of sodium nitrite. The clear diazonium solution is made up to a known volume in a calibrated flask and is then added, from a burette or a graduated cylinder, to a carbonate solution of β -naphthol of accurately determined strength. The end point is taken as the point where a spot test with diazonium solution on filter paper shows the absence of β -naphthol. Usually, the proportions of the reactants are so chosen that the number of cubic centimeters used divided into 100 gives the per cent of amine present in the original sample.

For example, 3.45 grams of *p*-nitroaniline (2.5/100 mole) is dissolved in 10 cc. 30 per cent hydrochloric acid and 10 cc. water. The clear solution is poured into 50 grams of water and 50 grams of ice and treated with a 20 per cent solution containing 2 grams of pure sodium nitrite. The clear solution, containing about 0.2 gram of excess NaNO_2 , is made up to 250 cc.

100 cc. of this solution is measured out in a graduate and added portionwise with thorough stirring to a solution containing 1.44 grams of 100 per cent β -naphthol, 2 cc. 30 per cent sodium hydroxide, and 20 grams of soda ash in 300 cc. ice water. Spot tests are made on filter paper to determine the point where the reaction mixture no longer gives a reaction for β -naphthol with diazonium solution. The number of cubic centimeters of nitroaniline solution divided into 100 gives the per cent purity. If the nitroaniline is 100 per cent pure, exactly 100 cc. is required. Usually, 101 to 102 cc. will be used.

Determination of Naphthols

β -Naphthol

A solution of 0.01 mole (1.44 grams) of β -naphthol in 2 cc. 30 per cent sodium hydroxide is diluted to 400 cc., and 25 cc. 10 per cent soda ash is added. Ice-cold 0.1 *N* phenyldiazonium solution is added from a graduated cylinder or a cooled burette until a drop of the re-

action mixture on filter paper forms no more orange red dye with the diazo solution. Impurities may cause the formation of a colored streak after a few seconds, but this is always cloudy and is easily distinguished, with a little practice, from the pure naphthol dye. The number of cubic centimeters of the diazonium solution used gives the per cent purity of the β -naphthol directly. A good product should be at least 99.5 per cent pure.

α -Naphthol

α -Naphthol couples much more easily than β -naphthol and would give too high values in alkaline solution. Hence, the coupling is carried out in acetic acid solution in the following manner:

The α -naphthol is dissolved as described for β -naphthol, and the solution is diluted and then precipitated with dilute acetic acid in the presence of 25 cc. 25 per cent sodium acetate solution. The coupling is carried out as with β -naphthol, except that when the reaction for α -naphthol disappears, the solution is made alkaline with sodium hydroxide, reprecipitated with acetic acid, and the titration continued until the α -naphthol reaction again disappears. Frequently, as much as 30 per cent of the total volume of the diazonium solution is added in the second part of the titration, since so much of the naphthol is carried down by the dye.

Only α -naphthol can be determined in this way since β -naphthol does not couple in acetic acid solution. If it is desired to determine the β -naphthol subsequently, 0.1 *N* *p*-nitrophenyldiazonium solution is added until all of the β -naphthol is reacted. Thus, it is easy to determine both α - and β -naphthols in impure α -naphthol samples.

Dihydroxynaphthalenes (Molecular Weight 160)

These compounds are determined in exactly the same way as α -naphthol. They couple very readily and the "after-coupling" is usually strong and very impure, so the endpoint is easily determined.

Determination of Aminosulfonic Acids

A solution of 0.01 mole of the acid in the required amount of soda solution is diluted to about 250 cc., acidified with 25 cc. concentrated hydrochloric acid, and titrated with 1 *N* nitrite solution. The per cent purity is given by no. of cc. \times 10. The endpoint must be determined by

spotting the starch-iodide paper, since accurate results cannot be obtained by streaking.

It should be noted that many highly reactive diazonium salts (especially when in strong mineral acid solution) rapidly turn starch-iodide paper blue, and it is essential, therefore, to know the sensitivity of the paper used. Sulfanilic acid, metanilic acid, and naphthylaminesulfonic acids are diazotized at 15°C. Cleve acids cannot be determined so easily because they couple with themselves immediately. In this case, it is best to add the bulk of the nitrite to the neutral solution and acidify the mixture with good stirring. The diazotization can also be carried out directly at 0°C., adding nitrite until the original violet color gives way to a pure brown. The indirect method is preferred, however, because it is more rapid.

Determination of Aminonaphtholsulfonic Acids

Two determinations are always made. In the first, the amount of nitrite which is used is measured to give the "nitrite value." Then, the compound is titrated with diazonium solution to give the "coupling value." If the two values agree, then it is known that the aminonaphtholsulfonic acid has been correctly made. If, on the other hand, the nitrite value is too high, it may be concluded that the fusion was too short. If the nitrite value is smaller than the coupling value, the fusion was carried too far. A correctly prepared aminonaphtholsulfonic acid should give nitrite and coupling values agreeing to within 1 per cent.

It is perhaps unnecessary to point out that all such determinations, like all analyses, should be run in duplicate.

H acid—1-Amino-8-naphthol-3,6-disulfonic Acid

(a) *Nitrite Value.* (Calculated in terms of the acid sodium salt, mol. wt. 341.) A solution of 3.41 grams of H acid in 5 cc. 10 per cent soda ash solution is diluted to 250 cc., precipitated with 25 cc. concentrated hydrochloric acid, and diazotized at 5°C. with 1 *N* nitrite solution. H acid should give a yellow diazo compound which can be salted out as beautiful crystals. The number of cubic centimeters of nitrite multiplied by 10 gives the per cent purity.

(b) *Coupling Value.* To a solution of 3.41 grams of H acid in 50 cc. 10 per cent soda solution, diluted to 300 cc., is added at 0°C. enough phenyldiazonium solution to give a minimum excess of diazo compound. The endpoint is determined by placing a few drops of the red reaction

mixture on a small heap of salt on filter paper. After 5 minutes, the colorless outflow is tested with diazotized aniline solution, and if H acid is present, a red ring is formed immediately. If the diazo solution is in excess, a red ring is formed with H acid solution. The last traces of H acid often react very slowly, and hence the last test should be delayed for 15 minutes or so. At the end of the reaction, more or less strong "after-coupling" always occurs, being weaker the purer the H acid being analyzed. The nitrite value of a good sample of H acid is about 0.3 per cent higher than the coupling value. The number of cubic centimeters is equal to the per cent purity.

All aminonaphtholdisulfonic acids, as well as the monosulfonic acids, are determined in this way. The diazonium solution is added from a 100-cc. graduate and the per cent purity is read off directly. Many laboratories use elegant, but complicated, ice-cooled burettes. The solution is stirred with a glass rod bent at the end to form a large loop. Coupling is conducted in a clean porcelain dish.

Determination of Naphtholmono- and -disulfonic Acids, and Dihydroxynaphthalenemono- and -disulfonic Acids

Example: Nevile-Winther Acid (1-Naphthol-4-sulfonic Acid) (Molecular Weight 224)

Coupling is carried out with a 0.1 *N* diazotized aniline solution, just as prescribed for H acid, and at the end the dye is salted out in the reaction dish so that the remainder of the naphtholsulfonic acid is easily determined. Starting out with a 2.24-gram sample, the volume of diazotized aniline in cubic centimeters gives the per cent purity directly. Coupling should be carried out at 0°C.

Schaeffer salt, R salt, and other naphtholsulfonic acids are analyzed in exactly the same manner. Sultones, on the other hand, must first be split by hot sodium hydroxide.

Dihydroxynaphthalenemono- and disulfonic acids couple so rapidly, even the second time, that the coupling is carried out in acetic acid solution containing sodium acetate, using diazotized *p*-aminoacetanilide. With many of the acids, the coupling requires several hours, as, for example, with chromotropic acid (1,8-dihydroxynaphthalene-3,6-disulfonic acid). In this case, also, the dye is highly soluble and separates slowly from the unreacted chromotropic acid so that considerable care must be exercised.

The determination of the individual sulfonic acids in a mixture can

be accomplished in some cases, although the results are rarely accurate. For example, mixtures containing Schaeffer salt (sodium 2-naphthol-6-sulfonate) and R salt (sodium 2-naphthol-3,6-disulfonic acid) can be analyzed in the following way. The total content of coupling substance is determined by titration with diazotized aniline solution. Another sample is dissolved in the minimum amount of water and treated with 20 parts of 96 per cent alcohol to precipitate the R salt. The mixture is shaken for about 30 minutes to free the Schaeffer salt enclosed in the precipitate, and then the precipitate and the filtrate are analyzed separately to determine R salt and Schaeffer salt, respectively.

A second method consists of first titrating the whole mixture with diazotized aniline, and then eliminating the Schaeffer salt in a second sample by means of formaldehyde. For example, 5 grams of the mixture is dissolved in 100 cc. water, and to the solution are added 5 cc. pure 30 per cent hydrochloric acid and 2.5 cc. 40 per cent formaldehyde. The mixture is heated for 1 hour on a water bath, and then reanalyzed, the difference between the two values representing the content of Schaeffer salt.

A third method utilizes iodine titration. Both R salt and Schaeffer salt are iodinated by iodine, preferably in the presence of sodium bicarbonate. A sample is titrated with 0.1 *N* iodine solution, adding an excess and back-titrating. A second sample is then separated into its constituents by alcohol, as described above, and a second determination is made. Some dye chemists believe that this is the best method, since the coupling methods give values which are too high; this belief is probably correct.

Determination of 2-Naphthylamine-5,7-disulfonic Acid in the Presence of 2-Naphthylamine-6,8-disulfonic Acid

The analysis of mixtures of these two acids is very simple. The mixture is first titrated with nitrite to determine the total of the two acids, and then the 2,5,7 acid is titrated with sodium hypobromite. The 2,5,7 acid reacts smoothly in hydrochloric acid solution with sodium hypobromite, taking up two atoms of bromine, while the 2,6,8 acid is entirely unreactive. This behavior is surprisingly similar to that of Schaeffer salt and R salt.

To carry out the second titration, a measured amount of the sulfonic acid sample is dissolved in 300 parts of water, and 20 cc. concentrated hydrochloric acid is added for each 2 grams of the sulfonic

acid. The temperature is lowered to 0°C. by addition of ice, and the solution is titrated with 0.2 N NaOBr solution to a definite blue coloration with starch-iodide paper. The 0.2 N hypobromite solution is prepared in the following way:

To a solution of 14 grams of pure NaOH in 500 cc. water containing about 200 grams of pure ice is added, with thorough stirring, 16 grams of bromine. The solution is diluted to 1 liter and standardized by known methods (e.g., with arsenious acid).

A dilute solution of the pure 2,6,8 acid containing hydrochloric acid gives an immediate test for free bromine with only one drop of the hypobromite solution.

Volumetric Determination of Dyes by the Edmund Knecht Reduction Method¹⁰⁵

In many cases, testing a dye for color strength and tint by means of a dyeing test is replaced by a simple analysis by reduction with titanium trichloride (TiCl₃) to determine the content of reducible substance present. This elegant method is usable for homogeneous products, but it fails if the dye being tested is a mixture of isomers, or if it contains impurities which also consume the reducing agent.

For these reasons, this method of analysis is not widely used in the older dye plants which are equipped with proper dyeing standards. It has, however, attained a certain popularity in smaller plants in England and America because it is much easier to carry out a simple titration than to conduct the delicate, but conclusive, dyeing test. The evaluation of a dyeing test is always dependent on individual factors and can only be done by trained, absolutely reliable persons.

Principle of the Knecht Method

Titanium trichloride is an extremely easily oxidized material which dissolves in water to form a violet solution. On oxidation, it is converted to the colorless titanous acid, Ti(OH)₄. Using a titanium trichloride solution of known strength, it is possible to reduce quantitatively dyes of various classes, the endpoint being taken as the point where the color of the dye disappears.

All azo dyes, as well as thiazine, safranin, triphenylmethane, indigo, and many other dyes, can be analyzed with great accuracy by means of

¹⁰⁵ See Knecht and Hibbert, *New Reduction Methods in Volumetric Analysis*. 2nd ed., Longmans, Green, London, 1928.

titanium trichloride. The method will be described here briefly, but reference should be made to Knecht's publications for further details.

Preparation of the Titanium Trichloride Solution

In principle, a known amount of ferrous iron is oxidized to ferric iron, and this is reduced with titanium trichloride using potassium thiocyanate as an indicator.

As the ferrous salt, Knecht used iron ammonium sulfate (Mohr salt) and oxidized this to ferric sulfate with 0.02 N potassium permanganate in sulfuric acid solution. The resulting ferric salt was then back-titrated with titanium trichloride solution. The other, equally simple method consists in dissolving pure iron wire in pure hydrochloric acid and oxidizing the ferrous chloride solution with a few drops of bromine. The excess bromine is removed by boiling and the solution is titrated with the titanium trichloride solution.

The commercial titanium trichloride solution (about 15 per cent) is diluted by mixing 100 cc. with 100 cc. pure 30 per cent hydrochloric acid. The mixture is heated to boiling and then made up to 1 liter at 18°C. This solution can be held unchanged by storing under carbon dioxide or hydrogen, but it should be restandardized at regular intervals.

To standardize the solution with iron, an iron solution containing exactly 2 grams of iron per liter is used. This solution should contain 5 per cent hydrochloric acid or sulfuric acid. As an example, it is found that 6.85 cc. of a titanium trichloride solution corresponds to 25 cc. of the iron chloride solution, using potassium thiocyanate as the indicator (spot test). Since the iron solution contains 2 grams of iron per liter, 1 cc. TiCl₃ solution corresponds to 0.05/6.85 or 0.007299 grams of iron.

Titration of Methylene Blue

One mole of methylene blue (mol. wt. 319.6) requires two equivalents of iron (112 grams) for reduction, and therefore 1 cc. titanium trichloride solution corresponds to:

$$\frac{0.007299 \times 319.6}{112} = \frac{0.02083 \text{ gram of methylene blue (C}_{16}\text{H}_{18}\text{N}_3\text{S)}{}}{1 \text{ cc.}}$$

For example, exactly 0.2 gram of methylene blue (zinc-free) is dissolved in about 100 cc. water in a 250-cc. round-bottomed flask. A

stream of carbon dioxide is passed into the flask and the solution is heated to boiling. Titanium trichloride solution is added from a burette to the boiling solution until the solution is just decolorized. Standard methylene blue (zinc-free, Geigy) required 7.86 cc. TiCl_3 solution for 0.2 grams of the dye (average of three titrations). The dye content is, therefore:

$$0.02083 \times 7.86 = 0.1637 \text{ gram of pure dye, or}$$

$$0.1637 \times 100/0.2 = 81.8 \text{ per cent purity}$$

Methylene Green (mol. wt. 364.6). Methylene Green is a nitro methylene blue and its reduction requires 6 equivalents of iron. Therefore, 1 cc. titanium trichloride solution is equivalent to:

$$\frac{0.007299 \times 364.6}{336} \text{ or } 0.00809 \text{ gram of dye}$$

0.2 gram of methylene green used 20 cc. titanium trichloride solution, and contained, therefore:

$$0.00809 \times 20 \text{ or } 1.618 \text{ gram of dye}$$

The purity is therefore 80.9 per cent. The color change in this titration is not very sharp.

Azo Dyes

Determination of azo dyes is done most satisfactorily in the presence of sodium tartrate which prevents the precipitation of the difficultly soluble dye acids (e.g., benzopurpurin, see Knecht,¹⁰⁵ pages 31-32). Yellow dyes cannot be easily titrated because titanium tartrate is strongly yellow in color.

The reduction takes place quantitatively according to the equation:

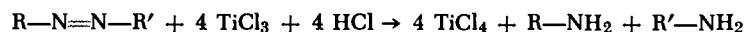

It is only necessary to know the molecular weight of the dye and the number of azo groups present. The titration is carried out exactly as described above.

Triphenylmethane Dyes

Reduction takes place according to the scheme:

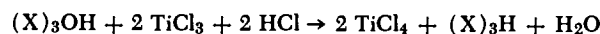

Titration is carried out to a colorless endpoint, which is usually very sharp. Knecht has titrated fuchsin, eosin, malachite green, acid

green, aniline blue, rhodamine, and other dyes by this method.

Safranine behaves exactly like methylene blue. The examples given show that the Knecht method is, in many cases, more rapid and more certain than dyeing tests, and it is, therefore, worthy of recommendation.

The Common Test Papers

1. **Litmus Paper.** This is an indicator for all acids and bases, weak or strong. Acids turn it red, bases blue. In preparing litmus paper, only the best litmus is used. The cubes, which contain from 50 to 90 per cent of gypsum, are broken up and extracted once with alcohol. The dye is then dissolved in water, 4 to 5 grams per liter, and pure filter paper is soaked in the solution. The sheet is suspended on a cord to dry and is then cut into thin strips. For red litmus paper, a few drops of acetic acid is added to the solution, and for blue litmus paper, a few drops of ammonia. The less pronounced the color of the paper, the more sensitive it is.

2. **Congo Red Paper.** This is a reagent for strong acids. It is turned to a pure blue by mineral acids and to a violet color by strong organic acids. The paper is prepared by soaking filter paper in a warm solution of 0.5 gram of Congo red in 1 liter of water containing 5 drops of acetic acid, and drying in a clean place.

3. **Thiazole Paper (Mimosa Paper).** This indicator is used to test for free alkali. It is colored a pure red by alkalis and is far better for this purpose than Curcuma. The paper is prepared as described for Congo red paper, except that the acetic acid is omitted. Ammonia has no effect on this paper unless it is in very concentrated solution.

4. **Phenolphthalein Paper.** This paper is turned red by alkalis, including ammonia and sodium carbonate solutions, but not bicarbonates. It can be used to advantage for differentiating among the alkalis. The paper is prepared by soaking filter paper in a hot solution of 1 gram of phenolphthalein in 1 liter of water.

5. **Starch-Iodide Paper (Nitrite Paper).** This is used to test for it blue violet, larger amounts turn it brown. This paper should be spotted and not streaked. Pure starch (10 grams) is rubbed with a small amount of water, and 1 liter of boiling water is added with thorough stirring. After the solution has cooled, 2 grams of potassium iodide is added and sheets of clean filter paper are soaked in it and allowed to dry in a clean place. This paper is very sensitive, giving a definite reaction nitrous and hypochlorous acids. Small amounts of oxidizing agents turn

with a 1 per cent hydrochloric acid solution containing one drop of 1 *N* nitrite solution per liter.

6. **Lead Paper.** This reagent for hydrogen sulfide, is prepared by soaking filter paper in a solution containing 5 grams of lead nitrate per liter, and drying in air free from H₂S. Instead of this paper, one can use paper moistened with ferrous sulfate or lead acetate solution.

Solutions for Spot Tests on Filter Paper

1. **H Acid Solution.** 1 per cent in 5 per cent soda, is used to test for easily coupling diazo compounds in spot tests on filter paper. R salt, β-naphthol, hydrocyanic acid, etc. can also be used for this purpose.

2. **Resorcinol Solution.** 1 per cent in 5 per cent soda is used to test for all diazo compounds including those which do not react with H acid.

3. **Diazotized *p*-Nitroaniline.** Reacts with all phenols and amines. It must be kept in the dark, and after 1 to 2 days it gives a yellow color with soda alone, so care is necessary in its use. Diazotized *o*-chloroaniline can be used equally satisfactorily.

4. **Sulfone Reagent.** This reagent is a 10 per cent solution of 4,4'-diaminodiphenylmethane-2,2'-sulfone in 2 *N* hydrochloric acid (see footnote on page 243). The solution becomes green in time and a dark colored precipitate forms, but the supernatant solution remains usable for a long time. Nitrite gives an intense but unstable blue coloration; the reaction is not prevented by strong acids or by weak oxidizing agents such as ferric salts.

5. **Alkali Sulfide Solution.** Used to test for heavy metals in solution (iron, copper, tin, etc.).

Evaluation of Zinc Dust

1 gram of Zn dust is dissolved in a solution of 4 grams of sodium bichromate in 1 liter water, and 20 cc. 20 per cent sulfuric acid added with thorough stirring. A 250-cc. portion of this solution is diluted with 900 cc. water, and 150 cc. 20 per cent sulfuric acid and 100 cc. 0.1 *N* potassium iodide solution are added. The mixture is allowed to stand *in the dark* for 30 minutes, and then the iodine is back-titrated with 0.1 *N* thiosulfate solution. To determine the strength of the bichromate, exactly 0.800 grams of it are treated in the same way.

Calculation: B = cc. thiosulfate for 0.800 g. bichromate

Calculation: A = cc. thiosulfate for 4 g. bichromate + 1. zinc dust

Then, $(B \times 1.25 - A) \times 1.308 =$ per cent zinc metal

Evaluation of Lead Peroxide Paste

A good average sample of 3 to 5 grams of the paste is weighed out between two watch glasses and treated with exactly 5 grams of Mohr salt. The mixture is rinsed into a 200-cc. flask and heated for 30 minutes on a boiling water bath, after which 25 cc. concentrated hydrochloric acid is added. The mixture is heated to boiling and, after cooling, the excess of Mohr salt is back-titrated with potassium permanganate.

V. The Analysis of Commercial Dyes

The determination of the constitution of an unknown commercial dye is one of the most interesting, but also one of the most difficult, tasks of the dye chemist. In the earlier days when only natural products were used, it was a relatively easy task, in many cases, to determine the origin of a product by examining its outward appearance. Cochineal, indigo, alizarin (madder) have such characteristic appearances that even the inexperienced could distinguish them. The only question involved was whether the product was suitable for the particular use in dyeing, or whether it had been either damaged or adulterated. The widely used inorganic colorants, such as Prussian blue, chrome oxide, iron oxide, vermilion, etc., could also be identified by purely qualitative investigation. The situation became quite different with the appearance of commercial organic dyes. Although in the early days of the dye industry, it was still relatively easy to identify, for example, fuchsin, aniline blue, methyl violet, or simple azo dyes, the difficulties increased as more new dyes appeared on the market. To be sure, attempts were made to alleviate these difficulties by compiling tables in which all known dyes were described accurately. So many new dyes were evolved as time went on, however, that it was not possible to keep pace with current developments, and the well-known dye tables of Schultz and Green became of less and less service. The question is no longer: "With which of the dyes described in the tables is this product identical?" but: "What is the composition of a dye which has not been mentioned in any scientific publication?"

The once widely used works, therefore, could no longer be used as the foundation for modern dye analysis, and new methods, independent of the older works, had to be worked out.

It would lead too far afield to try to present all the known facts in this book. On the other hand, it is of interest that the beginner should become acquainted, at least in broad outline, with the principles of modern dye analysis. To this end, references to publications in this

field are given at the end of this chapter, and three examples are given to illustrate the procedures used in determining the constitution of an unknown dye. This subject has been dealt with in some detail in an address given by the author.¹⁰⁶

Inasmuch as there is a lack of the more exact bases analogous to those on which the science of analytical chemistry is built, methods must sometimes be used which are not encountered in scientific research. Basically, however, the methods of modern dye analysis involve the same general principles as the classical analytical procedures. First of all, one must rely upon the available literature to gain a clear opinion as to how to proceed. Today, this literature is not contained, or is contained in only exceptional cases, in the scientific publications which are eventually collected in reference books like those of Beilstein and Gmelin-Kraut. There are, however, other sources which are useful in many cases. These sources are published patents, the trade journals of dye chemistry, and technical communications, all of which may give hints about a product in question.

The product often may be mentioned in a patent and frequently the dye package is labelled "Patented." The same dye is usually "announced" in the trade journals, and it may be assumed that the date of patenting is not far from the date on which the dye was placed on the market. Furthermore, the manufacturer of the dye is almost always known. Thus, it may be inferred that the dye has been patented by the manufacturer, either by means of an application made by him, or by assignment, and that the patent was granted, or at least applied for, before the first sale of the product. This type of investigation, of course, does not involve the methods of exact science, but, as it was once stated, it is more of the nature of detective work.

Still further importance is attached to the fact that a patent exists. Most patent laws require only that the general procedure be illustrated by several characteristic examples, and not that the disclosure specify the exact compound which is to be manufactured subsequently. The Swiss patent law, on the other hand, states expressly that only those products which are accurately described in the patent shall be given patent protection, and, in addition, that each patent can be drawn to only one product. If it is known, therefore, that a dye is patented in Switzerland, it can be assumed that the unknown dye is accurately described in one particular patent. A Swiss patent, therefore, could be of the greatest use in clearing up the constitution of a dye. In many

¹⁰⁶ Fierz-David, *J. Soc. Dyers Colourists*, 45, 133 (1929).

cases, these methods fail completely, as when no patent has appeared, or when the dye is manufactured by another firm after the expiration of the patent, or when the name of the dye is changed. Frequently in these cases, the structure can be ascertained by comparison of the properties of the dye with those of a known product.

At one time, the first source to be consulted for information on the nature of a dye was the well-known dye tables of Arthur Green. This work is so far out of date today that it is rarely consulted. The simple color reactions are of little use in modern times, and it is necessary, therefore, to evolve new methods which, unfortunately, are frequently time consuming and still lead to no useful end.

The group to which a dye belongs must first be established. This is relatively easily done, since the different dye classes exhibit different reactions. Thus, a vat dye would be sought in that group which gave the correctly colored vat. Indigo and thioindigo dyes give yellow or colorless vats. They dissolve in concentrated sulfuric acid to give, usually, yellowish green solutions, and they are reprecipitated unchanged from the alkaline reduction mixtures by air oxidation. With anthraquinone vat dyes, it is observed that the vats are usually intensely colored, and this difference permits easy differentiation between indigo and anthraquinone dyes. Further, many anthraquinone vat dyes yield anthracene or anthracene derivatives on distillation with zinc dust.

Many heterocyclic dyes behave analogously to ordinary indigo in that they are decolorized when treated with reducing agents and are regenerated on reoxidation. This applies to the azines, thiazines, oxazines, and other similar dyes. In contrast to these, the triphenylmethane dyes are decolorized easily by reduction, but their reduction products are usually considerably more difficult to reoxidize by air, i.e., the leuco compounds in this series are relatively stable. However, they can be very easily and quantitatively oxidized by chloranil (see page 146).

It is possible in some cases to obtain analytically pure dyes. This is most successful with the vat dyes, which can frequently be crystallized from a high boiling solvent such as chlorobenzene or nitrobenzene, or from glacial acetic acid or pyridine. Tetrabromoindigo (Ciba blue 2B), for example, can easily be obtained analytically pure from dichlorobenzene, as can other vat dyes of the type of indanthrene blue. With these dyes, quantitative chemical analysis is often of great value. Other special methods of analysis can also be employed, such as the Zeisel determination of alkoxy groups.

Consideration must also be given to the spectroscopic method of Formanek which depends on the determination of the absorption maximum. Formanek showed that many dye groups had characteristic absorption spectra, and his method is often of use. The tables compiled by Formanek, however, are out of date and are helpful only in recognizing the dyes which are listed. They are of as little use as the Schultz and Green tables with respect to dyes which have not been described.

One method which is very useful in the azo dye field is the so-called reductive-splitting reaction. Most azo dyes can be split at the $-N=N-$ group to produce two amines which can be separated and studied. Any nitro groups which are present are simultaneously reduced, of course. The reaction is effected by various reducing agents: hydrosulfite, stannous chloride, zinc dust, and many others. No reducing agent can be applied universally. In certain cases, hydrosulfite may bring about not only fission, but also the introduction of a sulfo group into one of the fission products. Stannous chloride, on the other hand, may cause a rearrangement (benzidine or semidine type) of the first-formed hydrazo compound. For example, orange I, the dye from diazotized sulfanilic acid and α -naphthol, on reduction with stannous chloride in hydrochloric acid solution, does not yield 1,4-aminonaphthol and sulfanilic acid, but instead it forms the semidine by rearrangement and no splitting occurs. In other cases, hydrosulfite carries the reduction only as far as the hydrazo stage and no splitting occurs. These cases, however, are the exceptions.

Since it is not within the scope of this book to go into great detail, we shall consider only the general principles of azo dye analysis.

It is first established whether the product is a single compound. This is done by dusting a small sample of the dye on moistened filter paper. A mixture can frequently be recognized from spots of different color. (Mixtures of water-insoluble dyes can often be detected by sprinkling a small sample onto concentrated sulfuric acid, advantageously placed in a depression in a white porcelain plate for the purpose.) Attempts are then made to purify the dye by reprecipitation until a pure material is obtained. Every effort is made to obtain the purest sample possible. This is a general rule for all dye analyses.

Reductive splitting is carried out, after the best conditions for the reaction have been established by experiment, and the resulting solution is investigated. Occasionally, part of the reduction products separate directly from the warm solution in a more or less pure condition. These are filtered off, recrystallized, and, if possible, analyzed quantita-

tively. The reduction product may already be described and the identity can be established by carrying out any necessary reactions. The small book by Brunner is useful in this connection.

Solutions prepared by stannous chloride reduction can advantageously be detinned electrolytically. This is an easy process to carry out and it has the advantage over H_2S precipitation that no foreign substances are added to the solution.

Mixtures of various dyes, as well as other compounds, can sometimes be separated by the Tswett chromatographic adsorption method. This elegant method is not widely applicable, however, succeeding only with simple dye mixtures.¹⁰⁷

If a pure reduction product is obtained, it is analyzed quantitatively and then it is established whether the product found can be related to an example in a patent. A quantitative analysis is not necessary in those cases where the product is a well known compound (aniline, sulfanilic acid, H acid, etc) or where its identity can be established by reference to tables. Thus, 1-amino- γ acid and 7-amino-H acid are recognized immediately, without further work, on the basis of accurately described color reactions. These color reactions are carried out by placing a dilute solution of the substance being investigated on filter paper and spotting it with various reagents such as metal salt solutions, acids, alkalis, oxidizing agents such as ferric chloride, hydrogen peroxide, etc. The colorations produced lead, in very many cases, to immediate recognition of the fission product, thus establishing part of the structure of the dye. When enough of the fission products have been identified, and the probable structure of the dye is established, perhaps by reference to a patent, the synthesis of the probable structure is undertaken. When the dye has been synthesized successfully, the task is complete.

Three examples will now be given of dyes which are not recognized from their appearance. These examples should show how one proceeds, in any given case, to identify a dye product. The dyes in question are: (1) Polar brilliant red 3B (Geigy). This dye has not been described in a German patent; (2) Benzo light grey BL (By). A patent could be found by searching the literature; and (3) Brilliant sulfo flavine (I.G.). Here, the inventor and the German patent number are identified in a communication which is available to anyone, and an analysis of the dye therefore appears unnecessary.

¹⁰⁷ Ruggli and Jensen, *Helv. Chim. Acta*, 18, 624 (1935). See also Zechmeister and Cholnoky, *Die chromatographische Adsorptionsmethode*. 2nd ed., Springer, Wien, 1938.

Polar Brilliant Red 3B and B

These two dyes were recently added to the sample card of the acid- and milling-fast Polar dyes of the J. R. Geigy A.G. firm. Since methods for preparing milling-fast azo dyes have not been patented by this firm for several years, it is assumed that the two Polar brilliant red dyes either come under an old disclosure or are not patentable at all.

Polar Brilliant Red 3B

Reduction with Hydrosulfite. The reprecipitated dye (30 grams) is dissolved in 250 cc. water containing enough soda to make the solution distinctly alkaline to litmus. Hydrosulfite is added in small portions to the boiling solution until it becomes colorless. An excess of hydrosulfite is to be avoided or sulfur may separate.

The yellowish brown oil which separates from the yellow reduction solution solidifies on cooling. It is recrystallized twice from aqueous alcohol, using decolorizing carbon, yielding a base melting at 68°C. The filtered reduction solution is acidified and treated with salt, and after a short time a voluminous white precipitate is formed. This is filtered off and washed with salt solution. From 50 grams of the commercial product, 9 to 10 grams of purified base and 15 grams of the sulfonic acid are obtained.

The base has the following properties: It dissolves in dilute hydrochloric acid only on warming, and, on cooling the solution, a hydrochloride separates which melts at 168–170°C. and which is hydrolyzed by water. If the hydrochloric acid solution is heated to about 80°, partial decomposition occurs, producing an oil volatile with steam. The base contains halogen, but not sulfur. Nitrogen and halogen determination give a 1:1 ratio of chlorine to nitrogen and a molecular weight of 219. The acetyl derivative melts at 166°.

The salted-out sulfonic acid can be diazotized and coupled, but is very stable otherwise. Its properties suggest *N*-acylated H or K acid.

Reduction with Stannous Chloride. A solution of 20 grams of the purified dye in 250 to 300 cc. water is heated to boiling in a round-bottomed flask fitted with reflux condenser and stirrer. A solution of 40 grams of stannous chloride in 100 cc. concentrated hydrochloric acid (1.19) is added and the mixture is boiled for 3 hours. If the solution is still not completely decolorized, more of the stannous chloride solution is added.

The tin is now removed electrolytically from the reduction mixture. The liquid is placed in an acid-resistant clay cell of 350-cc. capacity and the latter is placed in a porcelain or Pyrex beaker filled with 10 per cent sulfuric acid to the same level as the liquid in the cell. The tin is plated out on a copper gauze electrode at a temperature of 80–90°, using a carbon rod as anode. At an E.M.F. of 8 volts and a current of 6 to 8 amperes, all of the tin used to reduce 20 grams of dye is removed in 4 to 5 hours. Electrolyzing is continued until hydrogen begins to be evolved. Nothing crystallizes from the detinned solution, so it is evaporated in vacuum to half its volume. On cooling, a light gray powder comes out. This material exhibits the reactions of 7-amino-H acid. The spectrum of the oxidized material has the following bands: $\lambda = 530$ and $490 \text{ m}\mu$ (from 7-amino-H acid, $\lambda = 528$ and $491 \text{ m}\mu$)

The filtrate, which smells strongly of toluenesulfonyl chloride, is evaporated to dryness. The gray residue is treated with soda solution, and the solution is shaken out with ether. From the ether extract, a substance crystallizes which has a melting point of 140°C. and which is soluble in hydrochloric acid and sodium hydroxide, but not in soda solution. Ferric chloride gives a red color with the substance in hydrochloric acid solution. The compound contains halogen and can be diazotized and coupled with R salt to produce a dye. It is apparently a chloro-aminophenol.

One gram of the sulfonic acid from the hydrosulfite reduction is boiled under reflux with 20 cc. 10 per cent hydrochloric acid. After a short time, the solution can be oxidized by air or an oxidizing agent to produce the characteristic red color obtained from 7-amino derivatives of 1-amino-8-naphtholsulfonic acids. Since it is known that the Polar dyes contain the toluenesulfonyl group, it may be assumed that the acyl residue connected to the N is the *p*-toluenesulfonyl group.

The identification of the base is accomplished as follows. Since an aminophenol is formed in the stannous chloride reduction, the original structure was most probably that of an ester or an ether. 8 grams of the base is boiled with 80 cc. 20 per cent hydrochloric acid in a flask fitted with a downward condenser and steam is introduced simultaneously. A lachrymatory liquid distills. It is heavier than water and boils at 175°C. The compound, when warmed with silver nitrate, produces silver chloride. It is oxidized very rapidly by neutral permanganate solution to produce benzoic acid, m.p. 121°. The distillate is therefore benzyl chloride.

The liquid remaining in the flask is made alkaline with caustic soda

and filtered. It is then acidified and treated with soda solution. In the course of a day, white plates crystallize out. They melt at 139°C. This material is identical with the chloroaminophenol produced in the acid reduction of the dye. It is also identical with the chloroaminophenol derived from 2-nitro-4-chlorophenol. The original base is therefore 4-chloro-2-aminophenylbenzyl ether. This compound can be prepared synthetically by heating 1,4-dichloro-2-nitrobenzene with 2.5 moles of 10 per cent sodium hydroxide in an autoclave for 10 hours at 150–160° (see page 109). The resulting sodium salt of nitrochlorophenol is heated for 5 hours with benzyl chloride in alcoholic solution,¹⁰⁸ and the nitro ether is reduced. The base obtained in this way melts at 68°, either alone or mixed with the base from the dye.

By analysis, therefore, Polar brilliant red 3B has the structure:

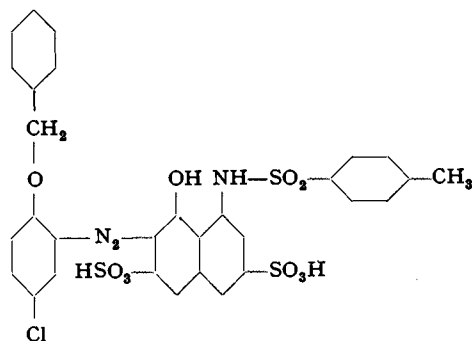

Synthesis of the Dye. To a solution of 0.1 mole of H acid in 200 cc. water containing 0.2 mole of soda is added with stirring, at 60–70°C., small portions of toluenesulfonyl chloride until the solution shows no reaction with nitrite. A two- to threefold excess of toluenesulfonyl chloride is required since a toluenesulfonyl group goes onto the hydroxyl group also. When the reaction is complete, enough soda is added to make the mixture a 10 per cent soda solution, and the mixture is boiled for 30 minutes to hydrolyze the toluenesulfonyl group on the —OH. The solution is then cooled in ice and the diazo solution is added. The reaction mixture is stirred for several hours, then warmed to 60° and salted out with a small amount of salt. The dye is purified by reprecipitation. No differences are found between the synthesized product and the original standard, either in dyeing properties or in characteristics in solution.

¹⁰⁸ Frische, *Ann.*, 224, 141 (1884).

Absorption of Solutions^a

Solvent	λ_{\max} in $m\mu$	
	Standard dye	Synthesized dye
H ₂ O	564.5, 522	Same except that bands are sharper, especially at 565
C ₂ H ₅ OH	561, 522.5, 490	Same
H ₂ SO ₄	616, 581	Same

^a The two bands are not very distinct.

Monoazo dyes prepared from *N*-toluenesulfonyl-H acid are, in themselves, not new,¹⁰⁹ and similarly, the use of aminophenylbenzyl ethers has previously been disclosed.¹¹⁰ It is to be expected, therefore, that Polar brilliant red 3B could not be patented. One point of scientific interest is the easy splitting of the chloroaminophenylbenzyl ether, merely by boiling with dilute hydrochloric acid, to produce benzyl chloride.¹¹¹

Benzo Light Grey BL¹¹²

Benzo light grey BL consists mainly of a blue gray dye mixed with a small amount of an orange red brown dye and, in certain cases, with some direct deep black. The presence of a mixture is clearly evident when a little of the dry powder is dusted onto wet filter paper. The blue gray dye can be obtained almost pure by reprecipitation (dissolving in hot water and salting out), leaving a mother liquor which dyes a dull brownish gray.

Reduction. Reduction of the reprecipitated dye with stannous chloride and hydrochloric acid produces a brown solution. Nothing separates out from the hot solution. The reduced solution is therefore electrolyzed directly and then evaporated somewhat. On cooling the solution, a light brown substance, rather sensitive to air, is obtained. This compound gives a condensation product with phenanthrenequinone which has an absorption band at 611.0 $m\mu$ in concentrated sulfuric acid solution. This phenanthrazine is identical with that from 1-amino- γ acid. Hence, in benzo light grey BL, acid-coupled γ acid is present, undoubtedly as an end component since γ acid couples only once. All other reactions also indicate that the reduction product is 1-amino- γ acid.

¹⁰⁹ Ges. f. Chem. Ind. Basel, Ger. Pat. 120,081 (1901) [*Frld.*, 6, 865 (1900–1902)].

¹¹⁰ M. L. B., Ger. Pat. 142,899 (1903) [*Frld.*, 7, 466 (1902–1904)].

¹¹¹ See also Schort and Stewart, *J. Chem. Soc.*, 1929, 553.

¹¹² Bayer, Ger. Pat. 293,184 (1916) [*Frld.*, 13, 515 (1916–1921); *C.A.*, 11, 1906 (1917)].

Further evaporation of the reduction mixture precipitates a second fraction whose properties are not very characteristic. This fraction is not a single compound. It gives no characteristic reaction with ferric chloride, showing the absence of a phenolic hydroxyl group, and it must be, therefore, a naphthylaminesulfonic acid or some other amino compound which gives no condensation product with phenanthrenequinone.

As a third fraction, a very easily soluble substance is obtained. This material gives a weak blue fluorescence in aqueous or weakly alkaline solution, resembling the fluorescence of naphthylaminesulfonic acids of the type of Freund acid, Laurent acid, or Acid IV. The substance can be diazotized and combined with R salt to produce a dye having two rather unsharp absorption bands at 515.8 and 490.8 m μ . These properties indicate that the reduction compound is Acid IV.

If the original dye is reduced with hydrosulfite and the resulting alkaline solution is steam distilled, no base is obtained in the distillate. There is present, therefore, no simple aromatic amine of the benzene series, but only sulfonic acids or naphthylamines.

Since such light fast, direct dyes are usually trisazo dyes, a possible structure is synthesized from 2-naphthylamine-4,8-disulfonic acid, α -naphthylamine, Cleve acid, and γ acid (acid coupling).

This compound dyes cotton blue gray from a weakly alkaline bath, the tint being practically identical with that given by purified benzo light grey BL.

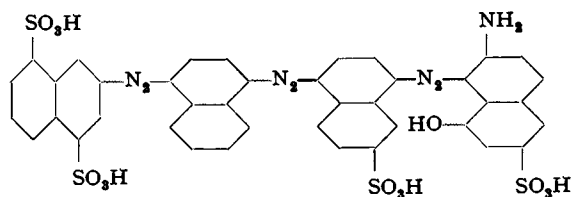

Preparation of the Dye. Acid IV (0.1 mole) is diazotized (like sulfanilic acid) and to the diazo solution is added a formic acid solution of α -naphthylamine. The coupling reaction is carried out for 24 hours, and the reaction mixture is then heated to boiling. The dye is salted out from the hot solution and reprecipitated from alkaline solution. The precipitated monoazo dye is then diazotized indirectly, and the diazo compound is filtered off and coupled with Cleve acid in the presence of formic acid. After 24 hours (the coupling reaction is slow), the solu-

tion is warmed up and made alkaline. The dye is salted out and reprecipitated 4 times until the mother liquor is reddish violet in color. This disazo dye is violet in alkaline solution and blue in acid, and goes directly on cotton. It is diazotized as above, the diazo compound is isolated and coupled in acetic acid solution with Gamma acid (γ acid dissolved in soda and acidified with acetic acid). After coupling, the solution is heated to 90°C. and made slightly alkaline with ammonia. The dye is then salted out and filtered off hot.

Brilliant Sulfo Flavine (I.G.)

This beautiful yellow dye first appeared on the market in 1930. It consists of a yellow powder which dissolves easily in water to give a pure yellow solution. Materials dyed by it are characterized by an extremely pure, almost dazzling, yellow color which cannot be matched by any other previously known yellow dye. The dyed materials exhibit intense fluorescence in ultraviolet light. It seemed probable that the dye was a new compound which would have been patented. In fact, a reference is found in the *Fortschritte der Teerfarbenchemie*, Vol. 18, p. 867, to German patent 531,291, in which new types of compounds are described as being very brilliant yellow dyes. The compound contains no azo grouping (not reducible to amines), but does contain nitrogen.

In the case of this dye, it is not necessary to carry out an analysis because soon after its introduction, the dye was mentioned in a small book by Dr. Georg Kränzlein.¹¹³ On page 53 of his book, Dr. Kränzlein says: "An advance in the clarity of tint is seen by comparing brilliant sulfo flavine (Eckert, Höchst, 1929), which is not a triphenylmethane dye, with the purest quinoline yellow available to date."

Now, German patent 531,291, mentioned above, was, in fact, issued to Dr. Eckert as the inventor, and since the name Eckert, to our knowledge, has not appeared elsewhere in patents describing dyes, we can assume that brilliant sulfo flavine is included in the I.G. patent.

Since the dye is patented, it is probable that it is represented by one of the five examples in the patent. The most likely possibility is example 3, the condensation product from 4-amino-1,8-naphthalic acid anhydride with cyclohexylamine, or example 4, the sulfonation product of this compound.

¹¹³ Kränzlein, *Werden, Sein, und Vergehen der künstlichen organischen Farbstoffe*, Ferdinand Enke, Stuttgart, 1935.

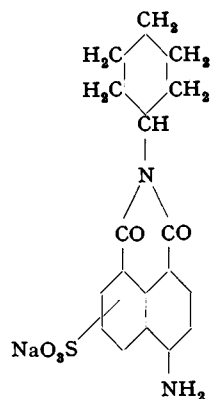

Although the dye is very brilliant, it is not particularly fast to light.

Thus, in this case, a search of the easily available literature has made a tedious analysis unnecessary.

Literature on Analysis of Dyes

1. P. Friedländer (continued by H. E. Fierz-David), *Fortschritte der Teerfarbenfabrikation*, Springer, Berlin, 1877-1940.
2. A. Winther, *Patente der organischen Chemie*, 1877-1905.
3. A. Green, *The Analysis of Dyestuffs*, 3rd ed., Griffin, London, 1920.
4. G. Schultz, *Farbstofftabellen*, 7th ed. with Ergänzungsband, Akadem. Verlagsgesellschaft, Leipzig, 1939.
5. Rowe, *Colour Index and Supplement*, London, 1924.
6. J. Formánek, *Untersuchung und Nachweis organischer Farbstoffe auf spektroskopischem Wege*, Springer, Berlin, 1908-1927.
7. A. Brunner, *Analyse der Azofarbstoffe*, Springer, Berlin, 1929. Additional literature is listed on page 117.
8. H. E. Fierz-David, "The Analysis of Dyestuffs, Yesterday and Today," *J. Soc. Dyers Colourists*, 45, 133 (1929).
9. H. E. Fierz-David and M. Matter, "Azo- and Anthraquinoid Dyes ing the Cyanuric Ring," *J. Soc. Dyers Colourists*, 53, 424 (1937).

Since many of the fission products obtained have never been accurately described, the larger handbooks, such as Beilstein, are of little help. On the other hand, it is absolutely necessary to study the available patents carefully, and, if necessary, to perform quantitative analysis on the products obtained, as pointed out in the introduction to this section. In this connection, reference should be made to the literature compilation given by Fierz and Matter (9, above). Note especially, Forster and Hanson, *J. Soc. Dyers Colourists*, 42, 272 (1926).

VI. The Determination of Light Fastness¹¹⁴

When dyes are exposed to daylight or sunlight, they undergo a change and are discolored and bleached. The rate of this fading varies greatly with different dyes and with different depths of color. Thus, some dyes are extensively faded by exposure to sunlight for 1 day, or even for a few hours. Others show a definite fading only after several days or weeks, or even after many months. Such dyes are said to have widely different light fastness.

The rapid growth of the synthetic dye industry made it necessary, at an early stage, to classify dyes according to their degree of light fastness. To this end, each individual manufacturer set up his own classification by comparing his dyes with standards arranged in order of increasing light fastness. The standards used were entirely arbitrary, and there was no relation between the standards of one manufacturer and those of another. A common basis was arrived at only after the formation, in 1911, of the *Deutsche Echtheitskommission*. A series of eight standard degrees of light fastness was set up, the first degree representing the lowest, and the eighth, the highest light fastness.

As a result of this effort, comparison standards for cotton and wool were distributed for the first time in 1914 and 1916. Then, after a long interval and contrary to the original decision, 5-degree standards were put out between 1926 and 1928 for unweighted silk, weighted silk, viscose rayon, and acetate silk. With these standards, it was possible for the first time to classify dyes in fastness groups according to a uniform system.

However, serious defects were soon apparent even in this system. After the six standard scales were prepared, requiring 33 dyes, the process of arriving at a reliable estimation of the degree of light fastness was very complicated and difficult because of the variations in color in the standards. Also, there was the difficulty that there was no uniformity of gradation in the standard dyeings with different textile fibers,

¹¹⁴ By Dr. Heinrich Ris.

and so the fastness ratings with different textiles were not comparable. This defect was especially troublesome with the artificial silks, particularly the mixed-fiber fabrics. From the fastness tables put out by the dye manufacturers, it was quite impossible for the dyers to select dyes of equal light fastness for use with mixed-fiber fabrics. Some remedy had to be worked out.

The I.G. Farbenindustrie worked for many years in an attempt to develop better standards for the different textile fibers, but these efforts did not achieve the desired improved standardization. During the course of this work, however, it became increasingly evident that other factors, in addition to exposure to light, had a significant effect on dye bleaching. Among these other factors were temperature, light intensity, and especially humidity and nature of the substrate. Thus, the fading of dyes on cotton and artificial silks was greatly affected by humidity, being much more rapid in moist air than in a dry atmosphere. Wool dyes, on the other hand, showed a much smaller dependence on humidity, as shown by extensive tests in which cotton and wool dyes were given identical exposures under the varying climatic conditions prevailing in some eighteen locations around the world.

These data led to the evolution of eight new dyeing standards for wool. Attempts were made to circumvent the troubles due to variations in tint and to limit the standards to a single constant tint. Gray would have been the best color to use for this purpose, because it would be the easiest to compare with all the different colors. Unfortunately, however, there were not enough gray dyes available for the purpose. The situation was much better with blue dyes, and it was possible, by careful selection of dyes and depths of coloring, to arrive at a set of eight standards making up an approximately geometric series with respect to light fastness. Within this series, then, each step requires about twice the exposure of the preceding step to produce the same degree of fading. It must be emphasized that the light fastness ratings 1 to 8 do not give a direct measure of the actual fastnesses. An idea of the magnitude of this progression is best afforded by a practical example. If Standard 1 shows definite fading after 2 days' exposure, the other standards will require approximately the following exposure times:

Standard	1	2	3	4	5	6	7	8
Exposure, days	2	4	8	16	32	64	128	256

Since these values vary, depending on the brightness of the daylight and the hours of sunshine, they must be regarded as approximate, average values.

The figures given above show clearly that groups 1 to 3 correspond to a very low light fastness, group 4 to medium, and group 5 to higher fastness. The groups from 6 on withstand rapidly increasing exposure times, and group 8 can be regarded as being outstandingly fast. These dyes in group 8 fulfill the very highest requirements, particularly since most textile fibers themselves are badly damaged or even completely destroyed on such long exposures. The light fastness ratings from 1 to 4 are given in whole numbers and those above 4 are expressed, if necessary, in half steps.

These new standards were accepted by the German *Echtheitskommission* and were published for the first time in the 6th edition of *Verfahren, Normen und Typen*.^{*} In the meantime, the series has been still further improved, and in the 8th edition, the present official standards were set up as follows:

Fastness rating 1.	0.8% Brilliant wool blue FFR extra
2.	1.0% Brilliant wool blue FFB
3.	1.2% Brilliant indocyanine 6B
4.	1.2% Supramine blue EG
5.	1.0% Cyananthrol RX
6.	3.0% Alizarin direct blue 3 GL
7.	3.0% Indigosol 06 B
8.	3.0% Indigosol blue ACG

Although the dyeing procedure was accurately described, it was still difficult for the outsider to dye up his own set of these blue standards. Hence, in order to eliminate all sources of error, the standards have been supplied free of charge by the German *Echtheitkommission* and by German and Swiss dye manufacturers.

The introduction of these standards simplified matters a great deal. By their use, it became possible to compare dyes of any depth or tint and, of special importance, on all the various fibers. Thus, this set of blue standards has become an *absolute standard* for the determination of light fastness and it has become possible to assign a numerical value for light fastness to every dye used in practice.

The actual determination of light fastness is very simple. The dyed material to be tested and the blue standard are half covered with cardboard and exposed together to daylight. The samples are exposed at least 2 cm. behind ultraviolet-transmitting glass in well-ventilated frames set at a 45-degree angle facing the south. When a distinct fading is ob-

^{*} *Verfahren, Typen, und Normen für die Prüfung und Beurteilung der Echtheitseigenschaften*, Verlag Chemie, Berlin, 1939. This also gives the procedures for determining other fastness ratings, such as fastness to washing, chlorine, alkali, and acid.

served in the test sample, a narrow strip of the exposed portion of the sample and of the standard is covered with cardboard, and exposure is continued until a definite change is again observed. A second strip is then covered and the exposure continued. The method must be changed somewhat if several dyed samples, differing in light fastness, are to be compared with the blue standards. In this case, exposure is continued, without regard for the fading of the samples being tested, until standard 4 shows a definite fading. Then a strip of the standards and test samples is covered, and exposure continued until standard 6 is observed to fade. A second strip is then covered, and exposure continued until standard 7 shows a distinct change. In this way, three fading strips are formed across the standards and the test samples. The fastness of a sample is then easily determined by locating the standard corresponding in degree of fading, and the fastness rating is then the number of the corresponding standard. The ratings can also be expressed in words as follows: 1, small; 3, moderate; 5, good; 6, very good; 7, excellent; 8, outstanding.

A simple and usable method has thus been found for determining the light fastness of *dyed materials*. There was still a need for a standard method for the evaluation of *dyes*. As is well known, a dye fades more rapidly in light tints than in the deeper tints, and different fastness ratings are obtained for one and the same dye depending on the depth of tint.

As a first step, it was necessary to establish exactly the depth of tint upon which the fastness of a dye was to be based. To this end, so-called auxiliary standards were set up, these being standardized dyeings, of *equal depth of tint*, in the most important colors: yellow, orange, red, violet, blue, green, brown, and gray. Marine blue and black were exceptions, these colors being based on more saturated shades corresponding to their use in practice.

A second important point involves a consideration of the textile fiber used. A direct dye on cotton, for example, exhibits a different degree of light fastness from the same dye on glossy viscose or on matte artificial silk. Still greater differences are found between weighted and unweighted silks, the former giving a lower degree of light fastness. It was necessary, therefore, to set up auxiliary standards using the more important fibers such as cotton, artificial silk, acetate silk, weighted natural silk, unweighted natural silk, and wool. These auxiliary standards can be ordered from the German or Swiss *Echtheitkommission* or from dye manufacturers.

These auxiliary standards are consistent in depth of tint for all colors

and all fibers, and hence the light fastness ratings for all dyes on all the fibers can be compared directly.

Marine blue and black are handled separately as already pointed out. Because they use a different strength for the auxiliary standards, marine blues can be compared directly only with themselves, and a black with blacks.

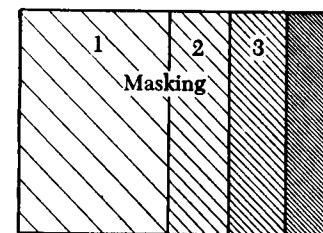

Fig. 57. Step exposure.

This is still not the complete picture. It is desired to give the dyers information about the fastness properties of light and dark tints, as well as of the middle tones. To this end, it was arranged that dyes should be evaluated in three depths of tint, having the relationship to the auxiliary standard of 1/3, 1, and 2. That is to say, the light tints were prepared using one-third, and the dark tints with twice, the amount of dye required to produce the depth of tint in the standard. In special cases, deviations from this rule were necessary, as with light rose or gray tones where one-sixth or one-ninth tints may be evaluated, or with saturated browns where four- or sixfold depths of tint may be used. The ratios used must always be specified. With marine blues, a double tint, and with black, a deep black, are measured.

Because of the varying strengths of dyes, these one-third and double tints are not of equal depth and hence are not comparable with each other. Comparable fastness ratings are usually signified by printing in bold face type.

This new method is the basis for determining the light fastness ratings by German and Swiss manufacturers. Tables are given, listing three ratings for all dyes on all the textile fibers with which they are used.

This system for evaluating dyes meets all the requirements of the dyeing trade. Each dyer is now able to select, from the tables, dyes which will be equal in light fastness for use with mixed fibers, and at the same time, have information about their behavior in light and dark tints.

Similar efforts are being made in England and America. Independen-

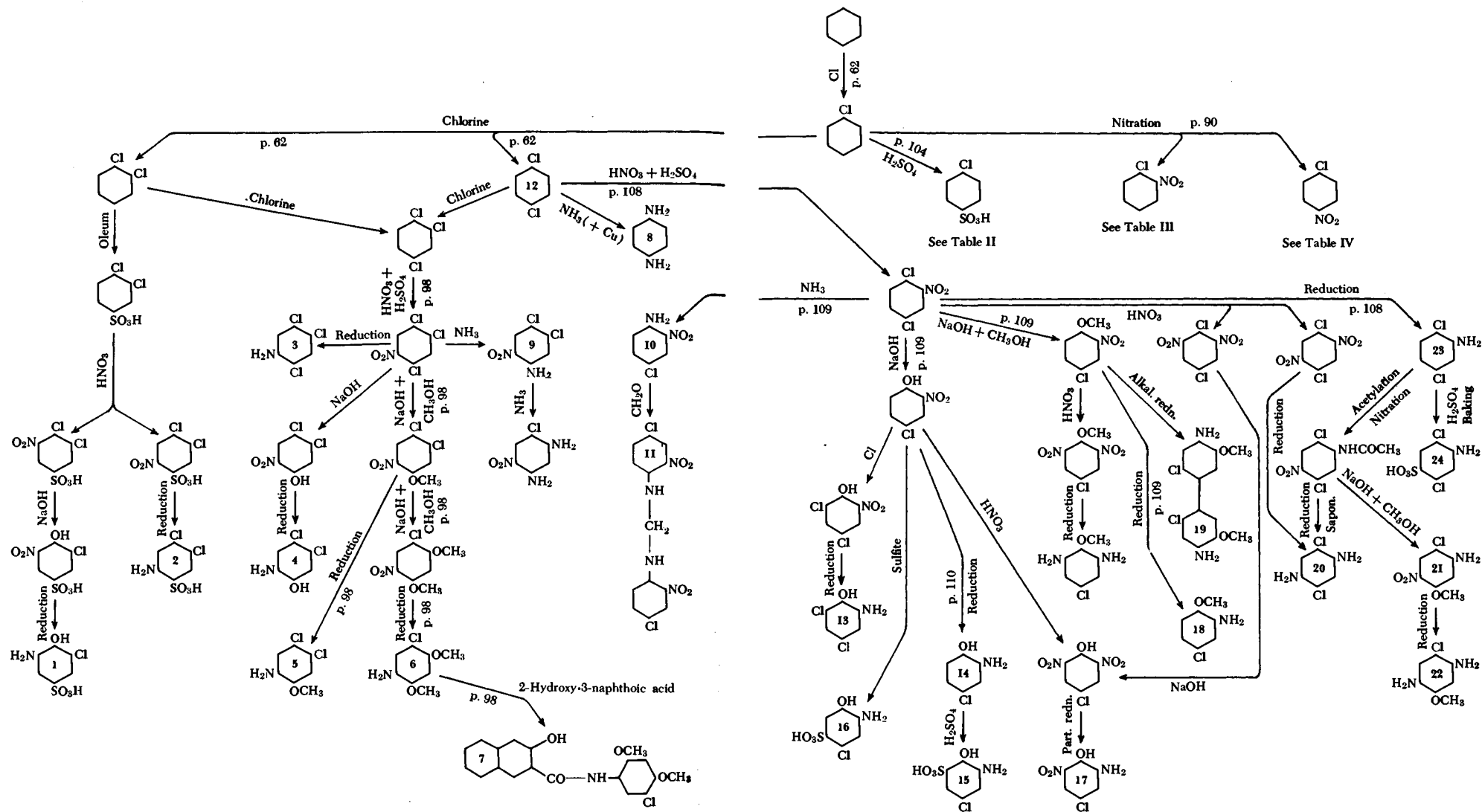
**Compound**

1. 6-Chloro-2-aminophenol-4-sulfonic acid
2. 3,4-Dichloroaniline-6-sulfonic acid (No. 12, Table IV)
3. 2,4,5-Trichloroaniline
4. 4,5-Dichloro-2-aminophenol
5. 4,5-Dichloro-2-anisidine
6. 6-Chloro-4-aminoresorcinol dimethyl ether
7. Naphthol AS ITR
8. *p*-Phenylenediamine (paramine brown) (No. 1, Table IV, and No. 5, Table VII)
9. 3,4-Dichloro-6-nitroaniline (No. 7, Table IV)
10. 4-Chloro-2-nitroaniline (fast red 3 CL base)
11. Lithol fast yellow GC
12. *p*-Dichlorobenzene

Principal Use

- Azo dyes (chrome)
Azo dyes (lake)
- Azo dyes (lake)
Azo dyes (chrome)
Azo dyes
Azo dyes
Azo dyes (ice colors)
Oxidation brown, fur dyeing, nitro dyes
Azo dyes (lake)
Azo dyes (lake, ice colors)
Pigment
Moth repellent

Compound

13. 4,6-Dichloro-2-aminophenol (No. 23, Table VIII)
14. 4-Chloro-2-aminophenol
15. 4-Chloro-2-aminophenol-6-sulfonic acid
16. 4-Chloro-2-aminophenol-5-sulfonic acid
17. 6-Nitro-4-chloro-2-aminophenol
18. 4-Chloro-2-anisidine (chloranisidine P, fast red R base)
19. Dichlorodanisidine
20. 2,5-Dichloro-*p*-phenylenediamine
21. 6-Nitro-4-chloro-3-anisidine
22. 2,5-Diamino-4-chloroanisole
23. 2,5-Dichloroaniline (fast scarlet CG base)
24. 2,5-Dichloroaniline-4-sulfonic acid

Principal Use

- Azo dyes (chrome)
- Azo dyes (chrome)
Azo dyes (chrome)
Azo dyes (chrome)
Azo dyes (chrome)
Azo dyes (lake, ice colors)
- Disazo dyes
Fur dyeing
Azo dyes
Fur dyeing
Azo dyes
Azo dyes, prazalone dyes

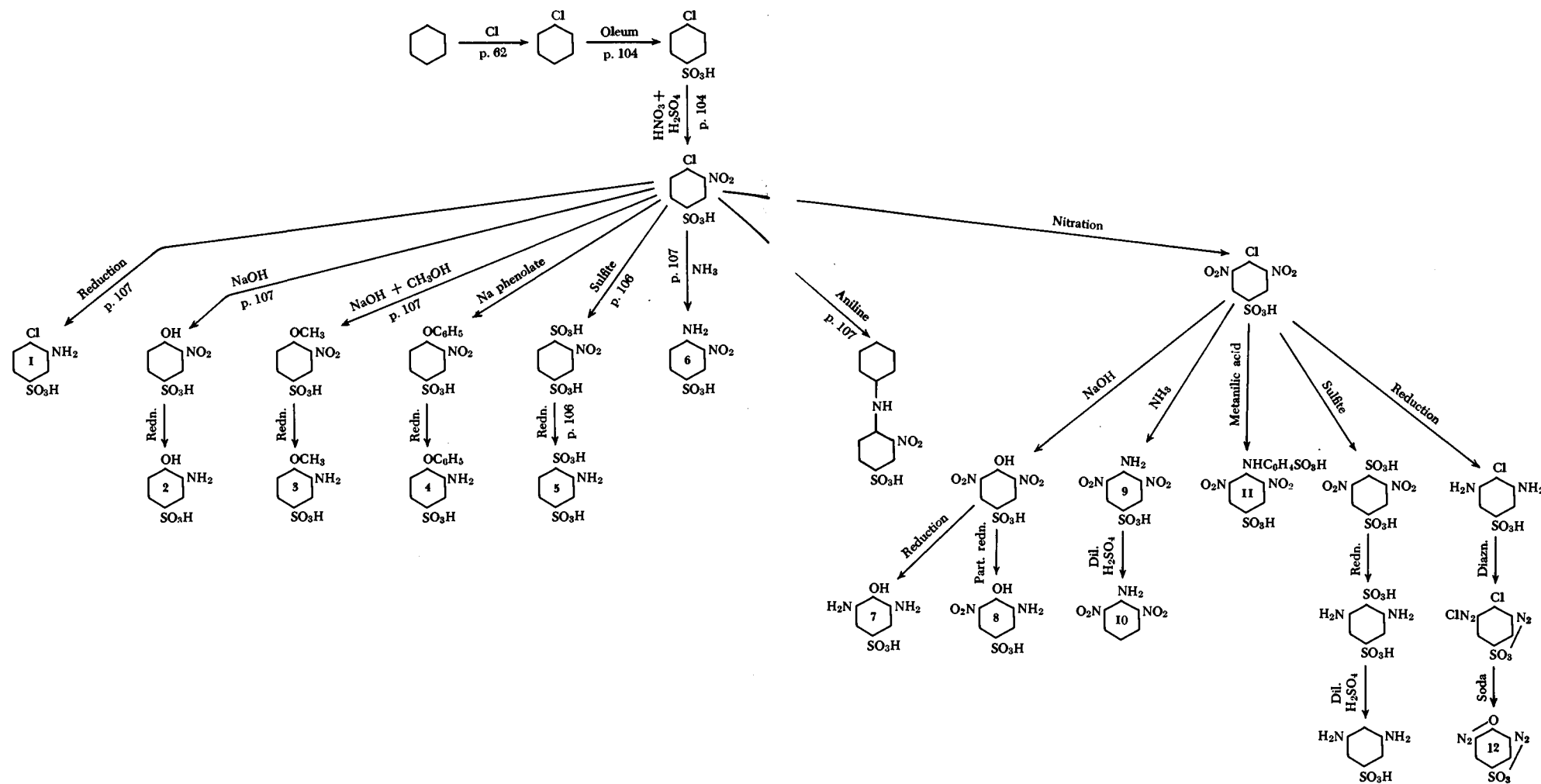

Compound

1. o-Chlorometanilic acid
2. o-Aminophenol-*p*-sulfonic acid
3. o-Anisidine-*p*-sulfonic acid (No. 9, Table III)
4. o-Aminodiphenylether-*p*-sulfonic acid
5. Aniline-2,5-disulfonic acid
6. o-Nitroaniline-*p*-sulfonic acid
7. 2,6-Diaminophenol-4-sulfonic acid (No. 12, Table VIII)

Principal Use

- Azo dyes
Azo dyes (chrome)
Azo dyes (lake)
Azo dyes (lake)
Azo dyes (esp. polyazo)
Azo dyes (lake)
Azo dyes (lake)

Compound

8. 6-Nitro-2-aminophenol-4-sulfonic acid (nitro acid I) (No. II, Table VIII)
9. 2,6-Dinitroaniline-4-sulfonic acid
10. 2,6-Dinitroaniline
11. 2,6-Dinitrophenylamine-4,3'-disulfonic acid
12. Tetrazo compound of No. 7

Principal Use

- Azo dyes (chrome)
Azo dyes
Azo dyes (lake)
Triphenylmethanes
Azo dyes (chrome)

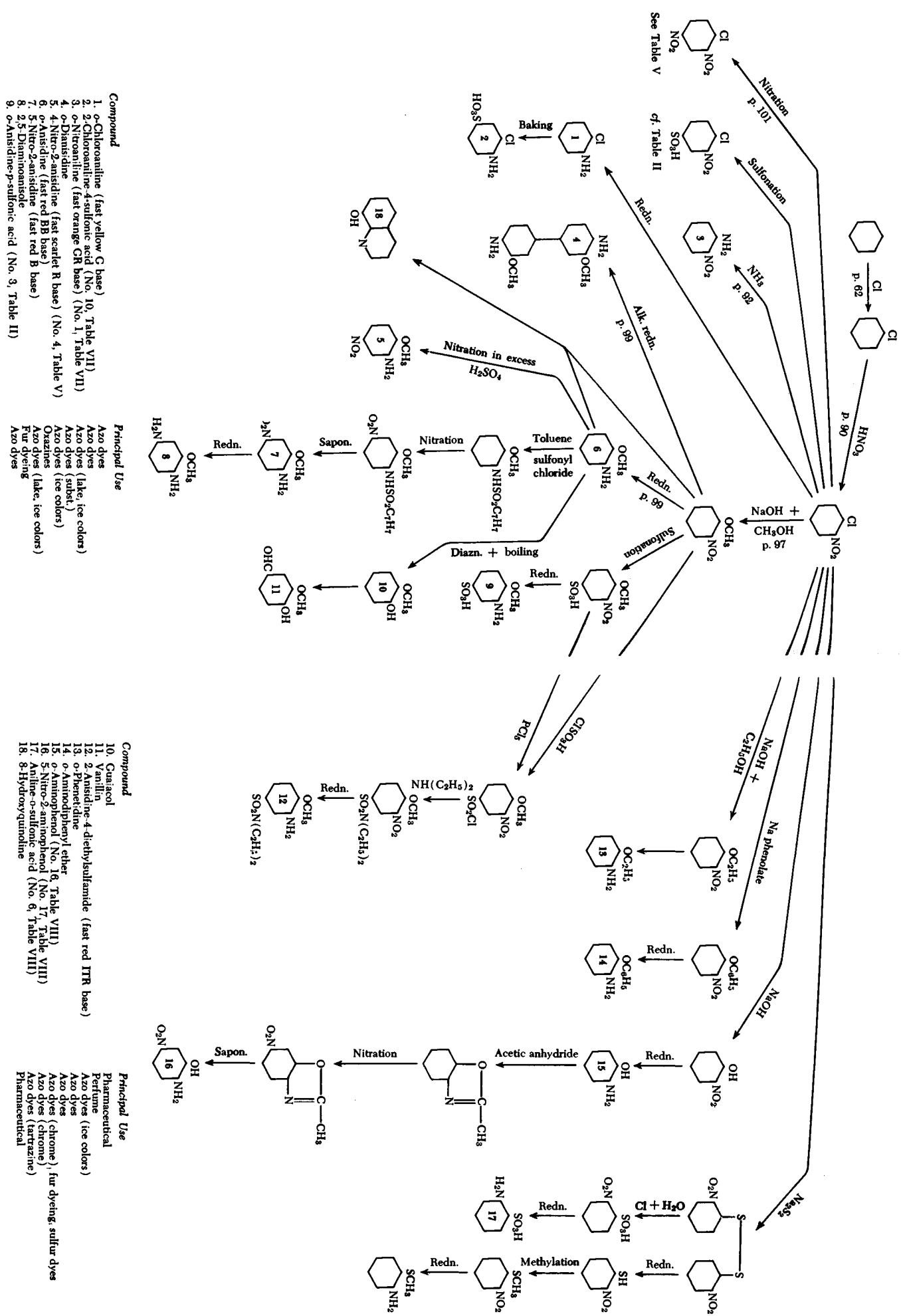

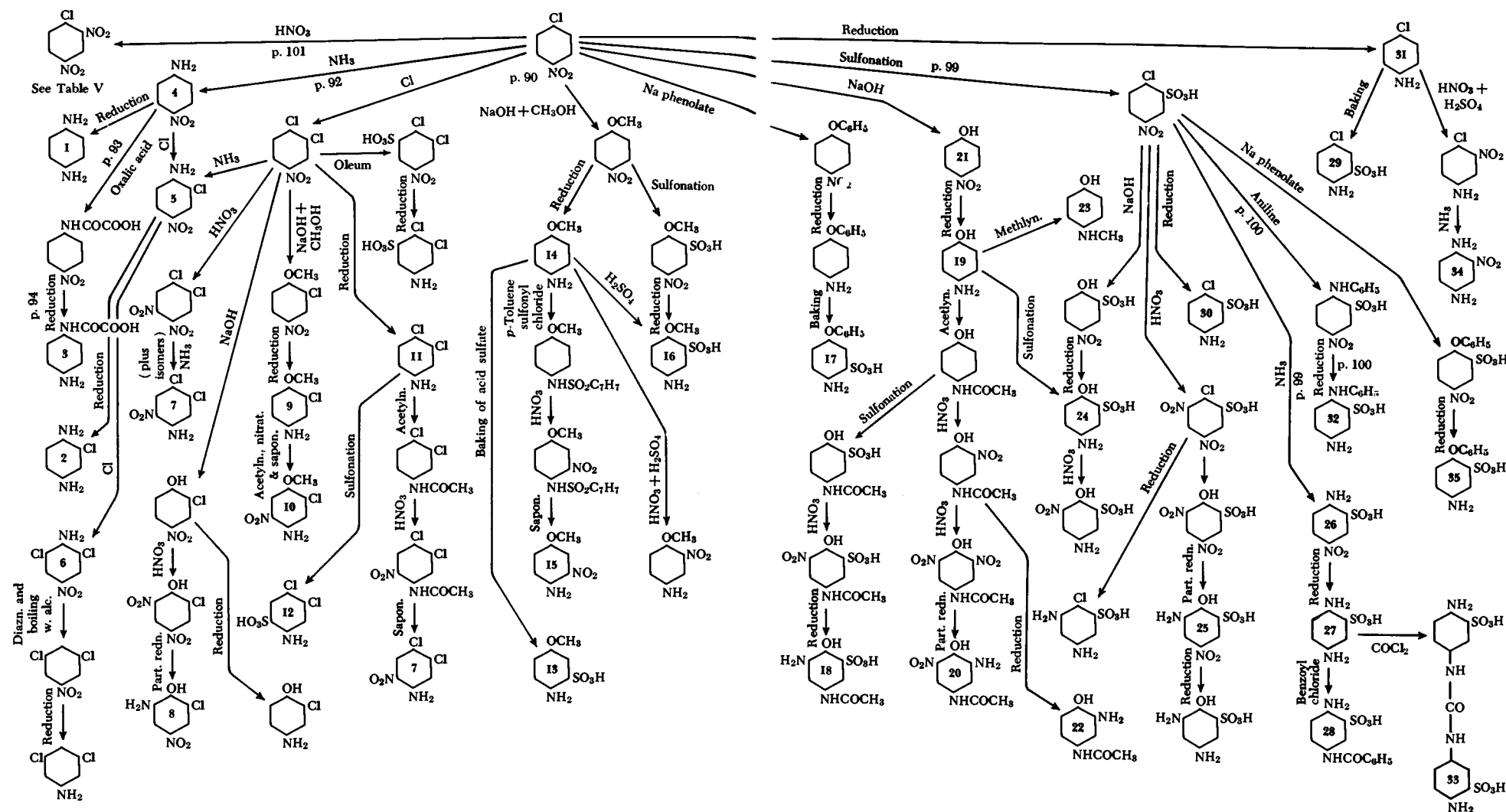
**Compound**

- p*-Phenylenediamine (paramine brown) (No. 8, Table I, and No. 5, Table VII)
- Chloro-*p*-phenylenediamine (No. 9, Table VI)
- p*-Aminophenyloxamic acid
- p*-Nitroaniline (fast red CG base) (No. 4, Table VII)
- 2-Chloro-4-nitroaniline
- 2,6-Dichloro-4-nitroaniline
- 3,4-Dichloro-6-nitroaniline (No. 9, Table 1)
- 4-Nitro-6-chloro-2-aminophenol
- 2-Chloro-4-anisidine (fast red R base)
- 5-Nitro-2-chloro-4-anisidine
- 3,4-Dichloroaniline
- 3,4-Dichloroaniline-6-sulfonic acid (No. 2, Table I)
- 4-Anisidine-3-sulfonic acid
- p*-Anisidine
- 3-Nitro-4-anisidine (fast Bordeaux CP base)
- 4-Anisidine-2-sulfonic acid
- 4-Aminodiphenylether-3-sulfonic acid
- 4-Acetamino-2-aminophenol-6-sulfonic acid

Principal Use

- Oxidation brown, fur dyeing, nitro dyes, sulfur dyes
Fur dyeing
Azo dyes (subst. polyazo)
Azo dyes (lake)
Azo dyes (lake)
Azo dyes (lake)
Azo dyes (chrome)
Azo dyes (ice colors)
Azo dyes (lake)
Azo dyes (lake)
Azo dyes (lake)
Azo dyes (lake)
Azo dyes (lake)
Azo dyes (lake)
Azo dyes (ice colors)
Azo dyes
Azo dyes
Azo dyes (chrome)

Compound

- p*-Aminophenol (No. 22, Table VIII)
- 6-Nitro-4-acetamino-2-aminophenol
- p*-Nitrophenol (No. 15, Table VIII)
- 4-Acetamino-2-aminophenol (No. 14, Table V)
- Monomethyl *p*-aminophenol
- p*-Aminophenol-*o*-sulfonic acid
- 4-Nitro-2-aminophenol-6-sulfonic acid (nitro acid III)
- p*-Nitroaniline-*o*-sulfonic acid
- p*-Phenylenediaminesulfonic acid
- Benzoyl-*p*-phenylenediaminesulfonic acid
- 4-Chloroaniline-2-sulfonic acid
- 4-Chloroaniline-3-sulfonic acid
- p*-Chloroaniline
- 4-Aminodiphenylamine-2-sulfonic acid
- 4,4'-Diaminodiphenylurea-3,3'-disulfonic acid
- Nitrophenylenediamine (No. 6, Table VII)
- 4-Aminodiphenylether-2-sulfonic acid

Principal Use

- Sulfur dyes, photography (developer)
Azo dyes (chrome)
Sulfur dyes
Azo dyes (chrome)
Photography (developer)
Azo dyes (as tosyl ester)
Azo dyes (chrome)
Azo dyes (lake)
Nitro dyes (amido yellow)
Azo dyes (lake)
Azo dyes
Azo dyes, pyrazolone dyes
Azo dyes
Azo dyes, nitro dyes (amido yellow), azines (wool fast blue)
Azo dyes
Oxidation brown, fur dyeing
Azo dyes

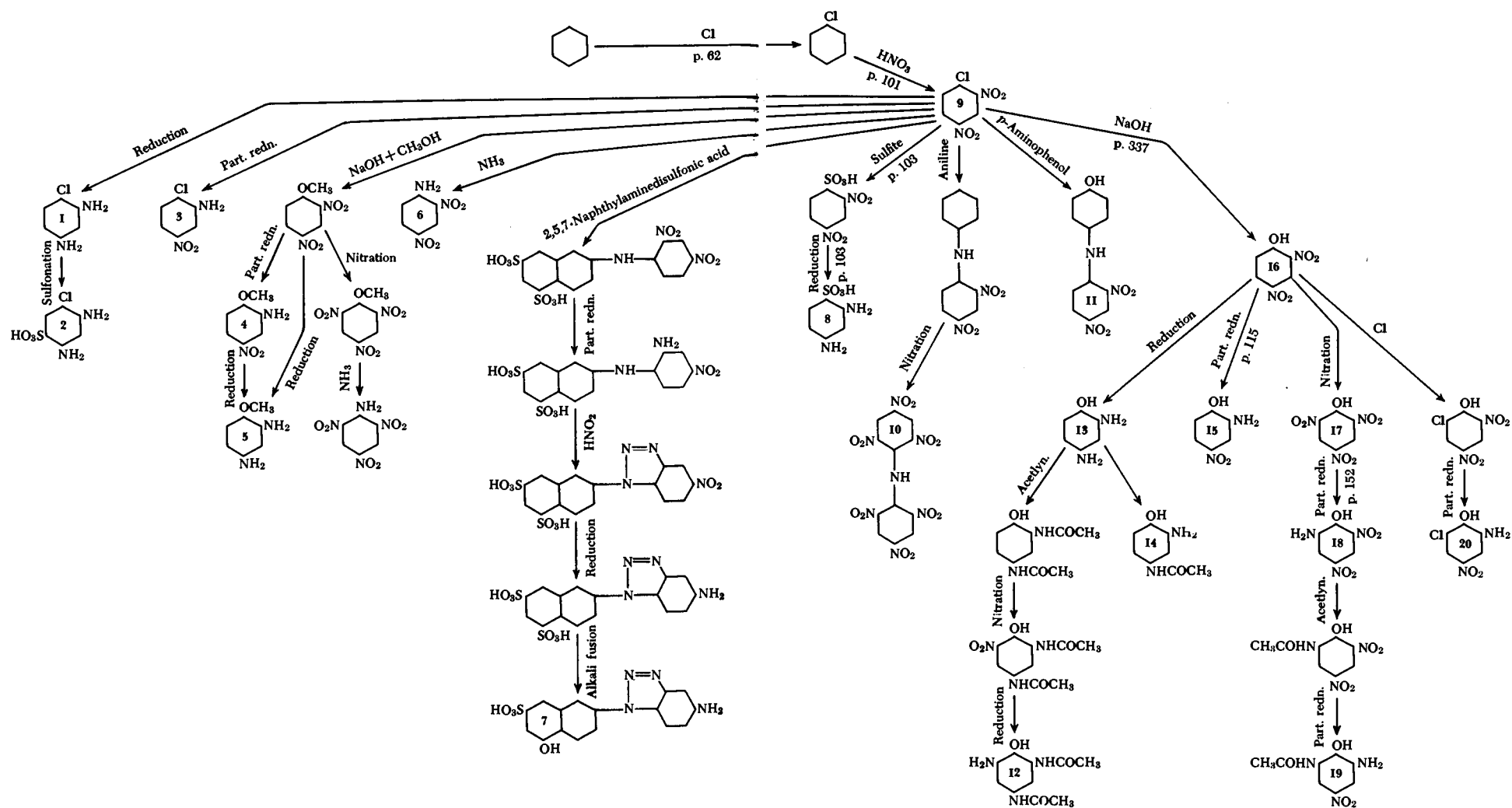

Compound

1. Chloro-*m*-phenylenediamine
2. Chloro-*m*-phenylenediaminesulfonic acid
3. Chloro-3-nitroaniline
4. 4-Nitro-2-anisidine (fast scarlet R base) (No. 5, Table III)
5. 2,4-Diaminoanisole
6. 2,4-Dinitroaniline
7. *p*-Aminoazimide of J acid
8. *m*-Phenylenediaminesulfonic acid
9. 2,4-Dinitrochlorobenzene
10. Hexanitrodiphenylamine

Principal Use

Azo dyes (end comp.)
 Azo dyes (end comp.)
 Azo dyes
 Azo dyes (ice colors)
 (No. 5, Table III)
 Azo dyes, fur dyeing
 Azo dyes (lake)
 Azo dyes (subst.)
 Azo dyes (end comp.)
 Nitro dyes (amido yellow),
 sulfur dyes
 Explosive

Compound

11. 2,4-Dinitro-4'-hydroxydiphenylamine
12. 4,6-Diacetamino-2-aminophenol
13. 2,4-Diaminophenol
14. 4-Acetamino-2-aminophenol (No. 22, Table IV)
15. 4-Nitro-2-aminophenol
16. 2,4-Dinitrophenol
17. Picric acid (No. 8, Table VIII)
18. Picramic acid (No. 9, Table VIII)
19. 4-Nitro-6-acetamino-2-aminophenol
20. 4-Nitro-6-chloro-2-aminophenol

Principal Use

Sulfur dyes
 Azo dyes (chrome)
 Photography (developer)
 Azo dyes (chrome)
 Azo dyes (chrome)
 Sulfur dyes
 Nitro dyes, explosive
 Azo dyes (chrome)
 Azo dyes (chrome)
 Azo dyes (chrome)

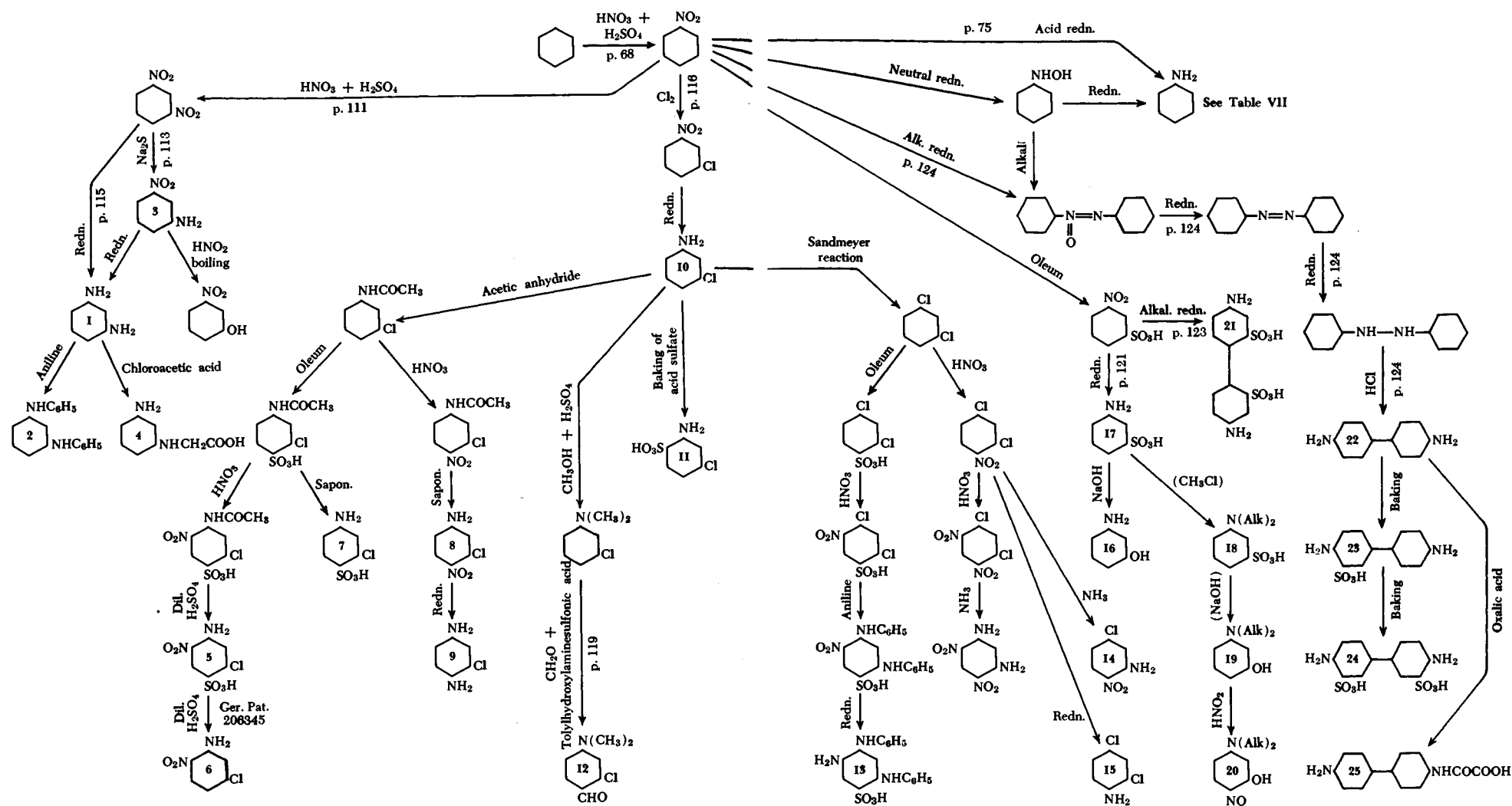

Compound

1. *m*-Phenylenediamine
2. Diphenyl-*m*-phenylenediamine
3. *m*-Nitroaniline (fast orange R base)
4. *m*-Aminophenylglycine
5. 3-Chloro-6-nitroaniline-4-sulfonic acid
6. 3-Chloro-6-nitroaniline (same as No. 14)
7. 3-Chloroaniline-4-sulfonic acid
8. 4-Nitro-3-chloroaniline
9. Chloro-*p*-phenylenediamine (No. 2, Table IV)
10. *m*-Chloroaniline (fast orange GC base)
11. 3-Chloroaniline-6-sulfonic acid
12. 2-Chloro-4-dimethylaminobenzaldehyde
13. 4,6-Dianilinometanilic acid

Principal Use

- Azo dyes, acridines, azines
Azines
Azo dyes
Azo dyes (end comp.)
Azo dyes (lake)
Azo dyes (lake)
Azo dyes
Azo dyes
Fur dyeing
Azo dyes, vat dyes
Azo dyes (lake)
Triphenylmethanes
Azines

Compound

14. Same as No. 6
15. 2,4-Dichloroaniline (No. 7, Table VII)
16. *m*-Aminophenol
17. Metanilic acid (No. 5, Table VIII)
18. Dialkylmetanilic acid (No. 30, Table VII)
19. Dialkyl-*m*-aminophenol (No. 31, Table VII)
20. Nitrosodialkyl-*m*-aminophenol
21. Benzidine-2,2'-disulfonic acid
22. Benzidine
23. Benzidine-3-sulfonic acid
24. Benzidine-3,3'-disulfonic acid
25. Benzidineoxamic acid

Principal Use

- Azo dyes
Oxidation dyes, azo dyes, fur dyeing
Azo dyes
Azo dyes (end comp.)
Rhodamines
Oxazines
Disazo dyes (acid and mordant)
Disazo dyes (subst.), sulfur dyes
Disazo dyes (subst.)
Disazo dyes (subst.)
Polyazo dyes (subst.)

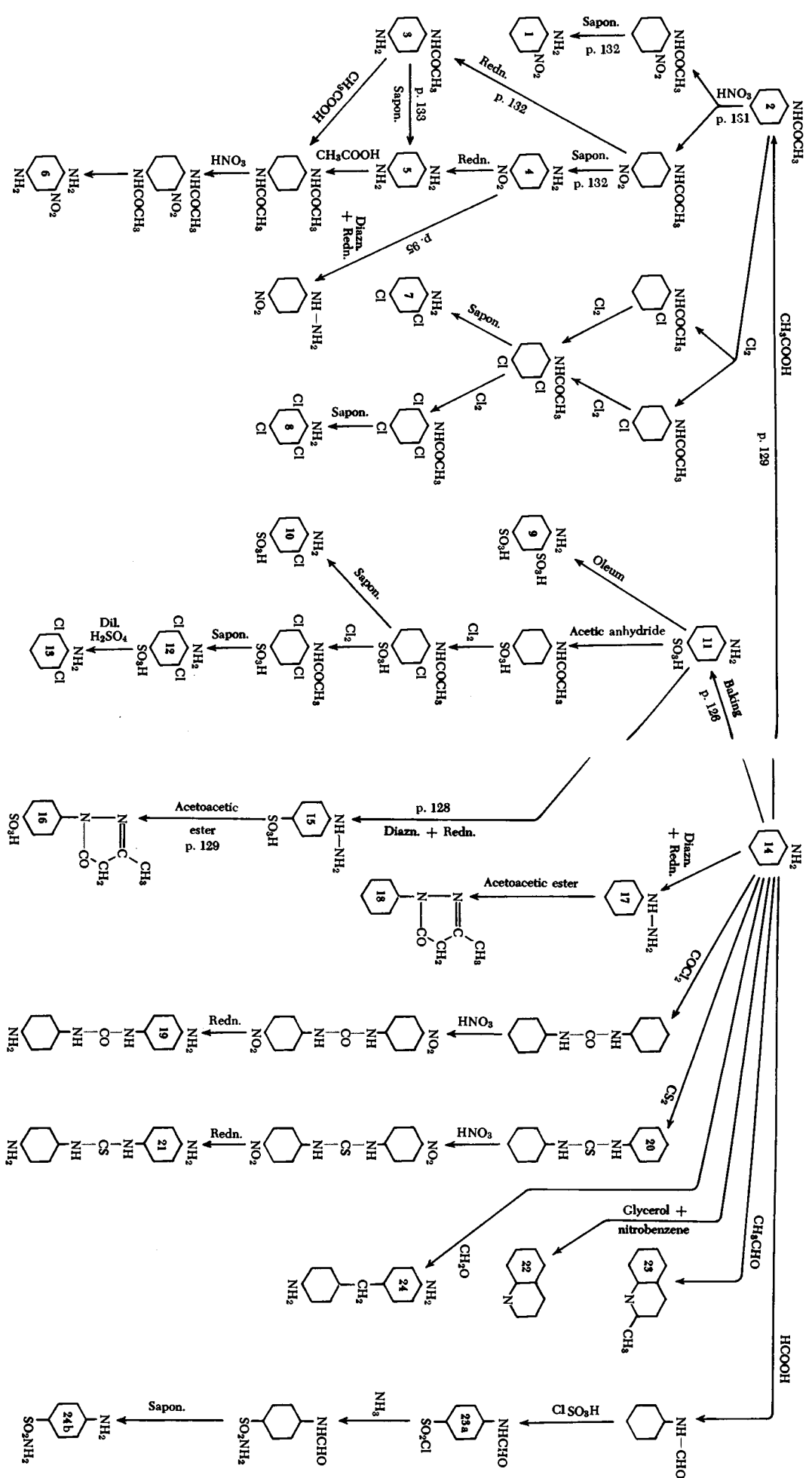

- Compound**
1. *o*-Nitroaniline (fast orange CR base) (No. 9, Table III)
 2. Acetanilide (antifebrin)
 3. *p*-Aminacetanilide
 4. *p*-Nitroaniline (fast red GG base) (No. 4, Table IV)
 5. *p*-Phenylenediamine (paramine brown) (No. 8, Table I, and No. 1, Table IV)
 6. Nitro-*p*-phenylenediamine (No. 34, Table IV)
 7. 2,4-Dichloroaniline (No. 15, Table VI)
 8. 2,4,6-Trichloroaniline
 9. Aniline 2,4-disulfonic acid
 10. 2-Chloroaniline-4-sulfonic acid (No. 2, Table III)
 11. Sulfanilic acid
 12. 2,6-Dichloroaniline-4-sulfonic acid
 13. 2,6-Dichloroaniline

- Principal Use**
- Azo dyes (lake, ice colors)
 - Antipyretic
 - Azo dyes
 - Azo dyes
 - Azo dyes
 - Oxidation dye, fur dyeing
 - Oxidation dye, fur dyeing
 - Azo dyes
 - Azo dyes
 - Azo dyes
 - Azo dyes, azines, acid antraquinone dyes
 - Azo dyes
 - Azo dyes

- Compound**
14. Aniline
 15. Phenylhydrazinesulfonic acid
 16. Phenylmethyldiazotomesulfonic acid
 17. Phenylhydrazine
 18. Phenylmethyldiazotomesulfonic acid
 19. *p,p'*-Diaminodiphenylurea
 20. Thiocarbamide
 21. *p,p'*-Diaminodiphenylthiourea
 22. Quinoline
 23. 4,4'-Diaminodiphenylmethane
 - 24a. Formanilide-*p*-sulfochloride
 - 24b. Sulfanilamide

- Principal Use**
- Multiple
 - Tartrazine
 - Azo dyes
 - Tartrazine
 - Azo dyes, pharmaceutical
 - Azo dyes
 - Indigo
 - Azo dyes
 - Photography (sensitizers)
 - Photography (sensitizers), quinophthalone dyes
 - Pharmaceutical (sulfanilamide)
 - Pharmaceutical

(continued in Table VIII)

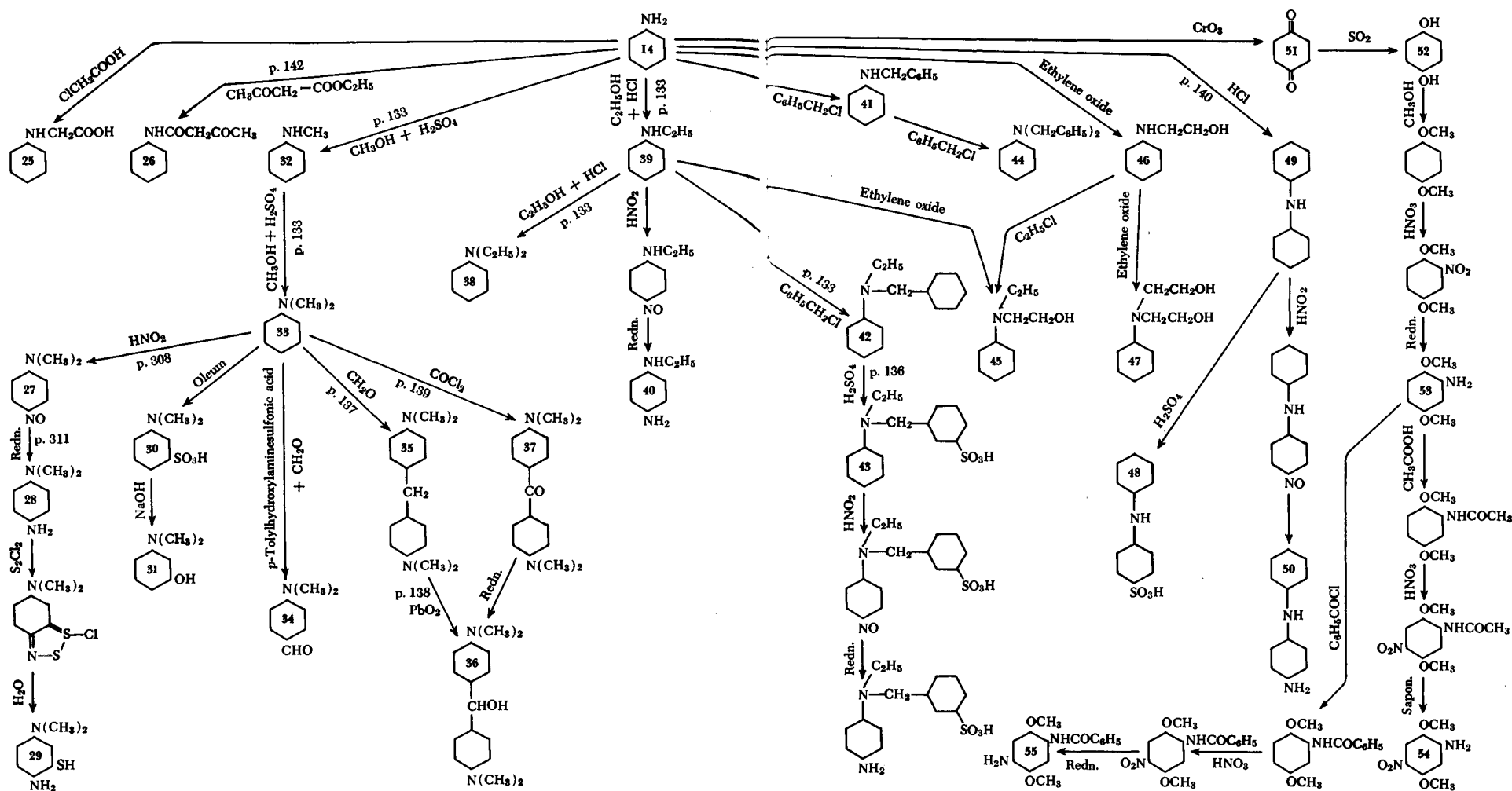

Compound

25. Phenylglycine
 26. Acetoacetanilide
 27. *p*-Nitrosodimethylaniline
 28. *p*-Aminodimethylaniline
 29. *p*-Aminodimethylanilinercaptan
 30. Dimethylmetanilic acid (No. 18, Table VI)
 31. Dimethyl-*m*-aminophenol (No. 19, Table 6)
 32. Monomethylaniline
 33. Dimethylaniline
 34. *p*-Dimethylaminobenzaldehyde
 35. 4,4'-Tetramethyldiaminophenylmethane (methane base)
 36. 4,4'-Tetramethyldiaminobenzhydrol (Michler hydrol)
 37. 4,4'-Tetramethyldiaminobenzophenone (Michler ketone)
 38. Diethylaniline
 39. Monoethylaniline
 40. Monoethyl-*p*-phenylenediamine

Principal Use

- Indigo
 Azo dyes (lake)
 Oxazines, azines, thiazines
 Thiazines, indophenols
 Sulfur dyes
 Azo dyes
 Rhodamines
 { Di- and triphenylmethanes, azines, oxazines,
 thiazines, sulfur dyes, acridine dyes, azo dyes
 Triphenylmethanes
 Auramine
 Triphenylmethanes
 Triphenylmethanes
 { Di- and triphenylmethanes, azines, oxazines,
 thiazines, sulfur dyes, azo dyes
 Azo dyes

Compound

41. Benzylaniline (No. 11, Table IX)
 42. Ethylbenzylaniline
 43. Ethylbenzylanilinesulfonic acid
 44. Dibenzylaniline
 45. Ethylhydroxyethylaniline
 46. Hydroxyethylaniline
 47. Dihydroxyethylaniline
 48. Diphenylaminemonosulfonic acid
 49. Diphenylamine
 50. *p*-Aminodiphenylamine (diphenyl black base, variamine blue RT base)
 51. Quinone
 52. Hydroquinone
 53. Aminohydroquinonedimethyl ether
 54. 5-Nitro-2-aminohydroquinonedimethyl ether
 55. 5-Benzoylamino-2-aminohydroquinone dimethyl ether (fast blue RR base)

Principal Use

- Triphenylmethanes, azo dyes
 Triphenylmethanes, azo dyes
 Triphenylmethanes, azo dyes, thiazines
 Triphenylmethanes, azo dyes
 Azo dyes
 Indigo, triphenylmethanes
 Azo dyes, triphenylmethanes
 Triphenylmethanes
 Triphenylmethanes, azo dyes, sulfur dyes
 Oxidation black, azo dyes, sulfur dyes
 Vat dyes (helindone)
 Photography (developer) anthraquinone dyes
 Azo dyes
 Azo dyes
 Azo dyes (ice colors)

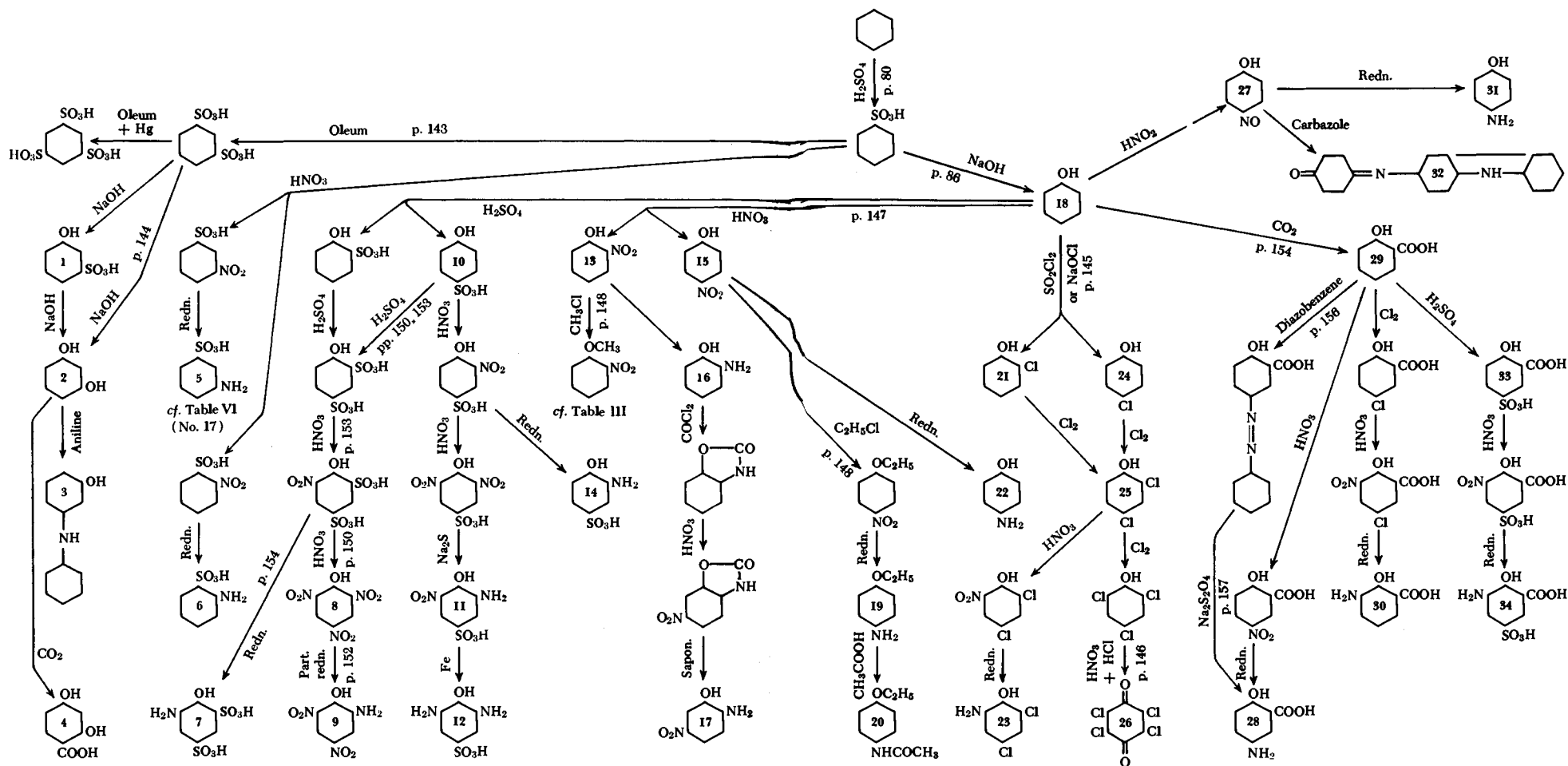

Compound

1. Phenol-*m*-sulfonic acid
2. Resorcinol
3. *m*-Hydroxydiphenylamine
4. Resorcylic acid
5. Metanilic acid (No. 17, Table VI)
6. Aniline-*o*-sulfonic acid (No. 17, Table III)
7. 2-Aminophenol-4,6-disulfonic acid
8. Picric acid (No. 17, Table V)
9. Picramic acid (No. 18, Table V)
10. Phenol-*p*-sulfonic acid
11. 6-Nitro-2-aminophenol-4-sulfonic acid (nitro acid I) (No. 8, Table II)
12. 2,6-Diaminophenol-4-sulfonic acid (No. 7, Table II)
13. *o*-Nitrophenol
14. *o*-Aminophenol-*p*-sulfonic acid
15. *p*-Nitrophenol (No. 21, Table IV)
16. *o*-Aminophenol (No. 15, Table III)
17. 5-Nitro-2-aminophenol (No. 16, Table III)

Principal Use

- Azo dyes
Eosins, azo dyes, nitroso dyes, oxazines
Triphenylmethanes, rhodanines, oxazines
- Azo dyes
Azo dyes
Azo dyes (chrome)
Nitro dye, explosive
Azo dyes (chrome)
Azo dyes
Azo dyes (chrome)
- Azo dyes (chrome)
- Sulfur dyes
Azo dyes (chrome)
Sulfur dyes
Azo dyes (chrome), fur dyeing
Azo dyes (chrome)

Compound

18. Phenol
19. *p*-Phenetidine
20. Phenacetin
21. *o*-Chlorophenol
22. *p*-Aminophenol (No. 19, Table IV)
23. 4,6-Dichloro-2-aminophenol (No. 13, Table I)
24. *p*-Chlorophenol
25. 2,4-Dichlorophenol
26. Chloranil
27. *p*-Nitrosophenol
28. *p*-Aminosalicylic acid
29. Salicylic acid
30. *p*-Chloro-*o*-aminosalicylic acid
31. Same as No. 22
32. Carbazoleindophenol
33. Sulfosalicylic acid
34. *p*-Sulfo-*o*-aminosalicylic acid

Principal Use

- Disinfectant, azo dyes, triphenylmethanes, sulfur dyes
- Azo dyes
Antipyretic
Azo dyes
Photography (developer), sulfur dyes, fur dyeing
Azo dyes (chrome)
Azo dyes, anthraquinone dyes
Disinfectant
Sulfur dyes, vat dyes (helindone), oxazines
Indophenols, sulfur dyes
Azo dyes (chrome)
Azo dyes, triphenylmethanes, anthraquinone dyes, pharmaceutical
Azo dyes (chrome)
- Vat dye (hydrone blue)
Azo dyes
Azo dyes (chrome)

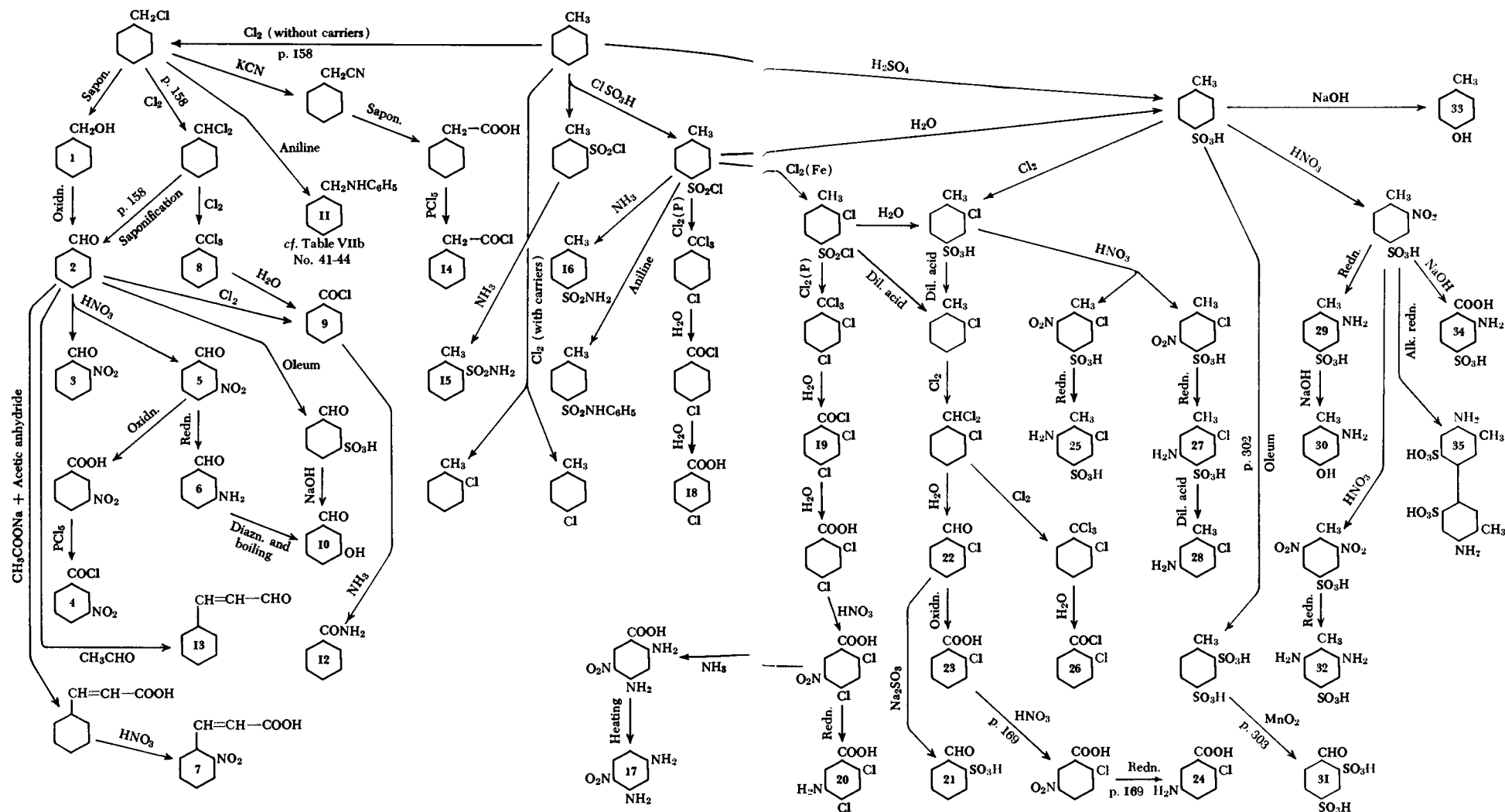

Compound

1. Benzyl alcohol
2. Benzaldehyde (oil of bitter almond)
3. *o*-Nitrobenzaldehyde
4. *m*-Nitrobenzoyl chloride
5. *m*-Nitrobenzaldehyde
6. *m*-Aminobenzaldehyde
7. *o*-Nitrocinnamic acid
8. Benzotrichloride
9. Benzoyl chloride
10. *m*-Hydroxybenzaldehyde
11. Benzylaniline (No. 41, Table VII)
12. Benzamide
13. Cinnamaldehyde
14. Phenylacetyl chloride
15. *o*-Toluenesulfamide
16. *p*-Toluenesulfamide
17. Nitro-*p*-phenylenediamine
18. *p*-Chlorobenzoic acid

Principal Use

- Perfume
 Perfume, triphenylmethanes, acridines
 Indigo
 Azo dyes (rosanthrene), pharmaceutical
 Triphenylmethanes
 Triphenylmethanes
 Indigo
 Triphenylmethanes
 Multiple
 Triphenylmethanes
 Triphenylmethanes
 Anthraquinone vat dyes
 Perfume
 Ciba lake red B
 Saccharin
 Disinfectant
 Azo dyes
 Triphenylmethanes

Compound

19. 2,4-Dichlorobenzoyl chloride
20. 4,6-Dichloro-3-aminobenzoic acid
21. Benzaldehyde-*o*-sulfonic acid
22. *o*-Chlorobenzaldehyde
23. *o*-Chlorobenzoic acid
24. 6-Chloro-3-aminobenzoic acid
25. 6-Chloro-2-toluidine-4-sulfonic acid
26. *o*-Chlorobenzoyl chloride
27. 6-Chloro-3-toluidine-4-sulfonic acid
28. 6-Chloro-3-toluidine
29. 2-Toluidine-4-sulfonic acid
30. 2-Amino-4-cresol
31. Benzaldehyde-2,4-disulfonic acid
32. 2,6-Tolylenediamine-4-sulfonic acid
33. *p*-Cresol
34. *p*-Sulfantranilic acid
35. *o*-Toluidine-*m*-disulfonic acid

Principal Use

- Azo dyes (anthosines)
 Azo dyes
 Triphenylmethanes
 Triphenylmethanes
 Anthraquinone-acridones
 Azo dyes
 Azo dyes
 Azo dyes, vat dyes
 Azo dyes (lake)
 Azo dyes
 Azo dyes
 Rhodamines
 Triphenylmethanes
 Azo dyes
 Disinfectant, azo dyes
 Azo dyes (lake)
 Azo dyes

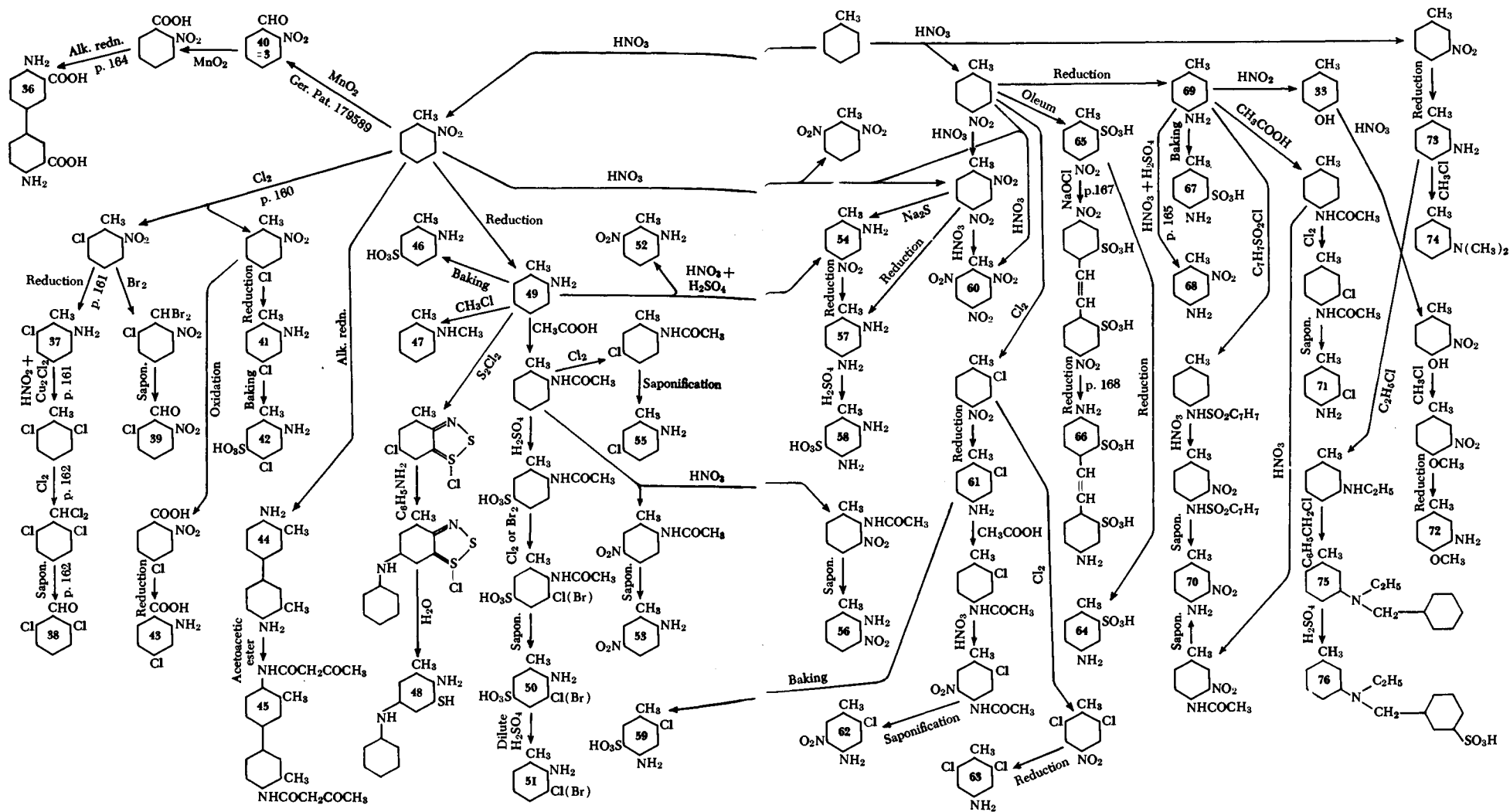

Compound

36. Benzidine-3,3'-dicarboxylic acid
 37. 6-Chloro-2-toluidine (fast scarlet TR base)
 38. 2,6-Dichlorobenzaldehyde
 39. 2-Chloro-6-nitrobenzaldehyde
 40. Same as No. 3
 41. 4-Chloro-2-toluidine (fast red KB base)
 42. 4-Chloro-2-toluidine-5-sulfonic acid
 43. 4-Chloroanthranilic acid
 44. *o*-Toluidine
 45. Diacetoacet-*o*-toluidide (naphthol AS G)
 46. 2-Toluidine-5-sulfonic acid
 47. Monomethyl-*o*-toluidine
 48. 5-Anilino-2-amino-3-mercaptoptoluene
 49. *o*-Toluidine
 50. 3-Chloro(bromo)-2-toluidine-5-sulfonic acid
 51. 3-Chloro(bromo)-2-toluidine
 52. 6-Nitro-2-toluidine
 53. 5-Nitro-2-toluidine (fast red RL base)
 54. 4-Nitro-2-toluidine (fast scarlet G base)
 55. 5-Chloro-2-toluidine (fast red TR base)
 56. 3-Nitro-2-toluidine

Principal Use

- Azo dyes
 Azo dyes (ice colors)
 Triphenylmethanes
 Halogenated indigo
 Azo dyes (ice colors, lake)
 Azo dyes (lake)
 Azo dyes
 Azo dyes (subst.)
 Azo dyes (ice colors)
 Di- and triphenylmethanes, thiazines
 Sulfur dyes
 Multiple
 Azo dyes (tartrazine)
 Azo dyes
 Azo dyes
 Azo dyes (ice colors)
 Azo dyes (ice colors), thioindigo dyes
 Azo dyes (ice colors)
 Azo dyes

Compound

57. *m*-Tolylenedianiline
 58. *m*-Tolylenedianinesulfonic acid
 59. 2-Chloro-4-toluidine-5-sulfonic acid
 60. Trinitrotoluene
 61. 2-Chloro-4-toluidine
 62. 5-Nitro-2-chloro-4-toluidine
 63. 2,6-Dichloro-4-toluidine
 64. 4-Toluidine-2-sulfonic acid
 65. 4-Nitrotoluene-2-sulfonic acid
 66. *p,p'*-Dianilinostilbenedisulfonic acid
 67. 4-Toluidine-3-sulfonic acid
 68. 2-Nitro-4-toluidine
 69. *p*-Toluidine
 70. 3-Nitro-4-toluidine (fast red C base)
 71. 3-Chloro-4-toluidine
 72. Cresidine
 73. *m*-Toluidine
 74. Dimethyl-*m*-toluidine
 75. Ethylbenzyl-*m*-toluidine
 76. Ethylbenzyl-*m*-toluidinesulfonic acid

Principal Use

- Azo dyes, acridines, azines, sulfur dyes
 Azo dyes
 Azo dyes (lake)
 Explosive
 Azo dyes (lake)
 Azo dyes (lake)
 Azo dyes
 Azo dyes
 Stilbene dyes (subst.)
 Azo dyes (subst.)
 Azo dyes
 Azo dyes
 Multiple
 Azo dyes (lake, ice colors)
 Azo dyes
 Azo dyes (middle comp.)
 Azo dyes
 Triphenylmethanes
 Triphenylmethanes
 Triphenylmethanes

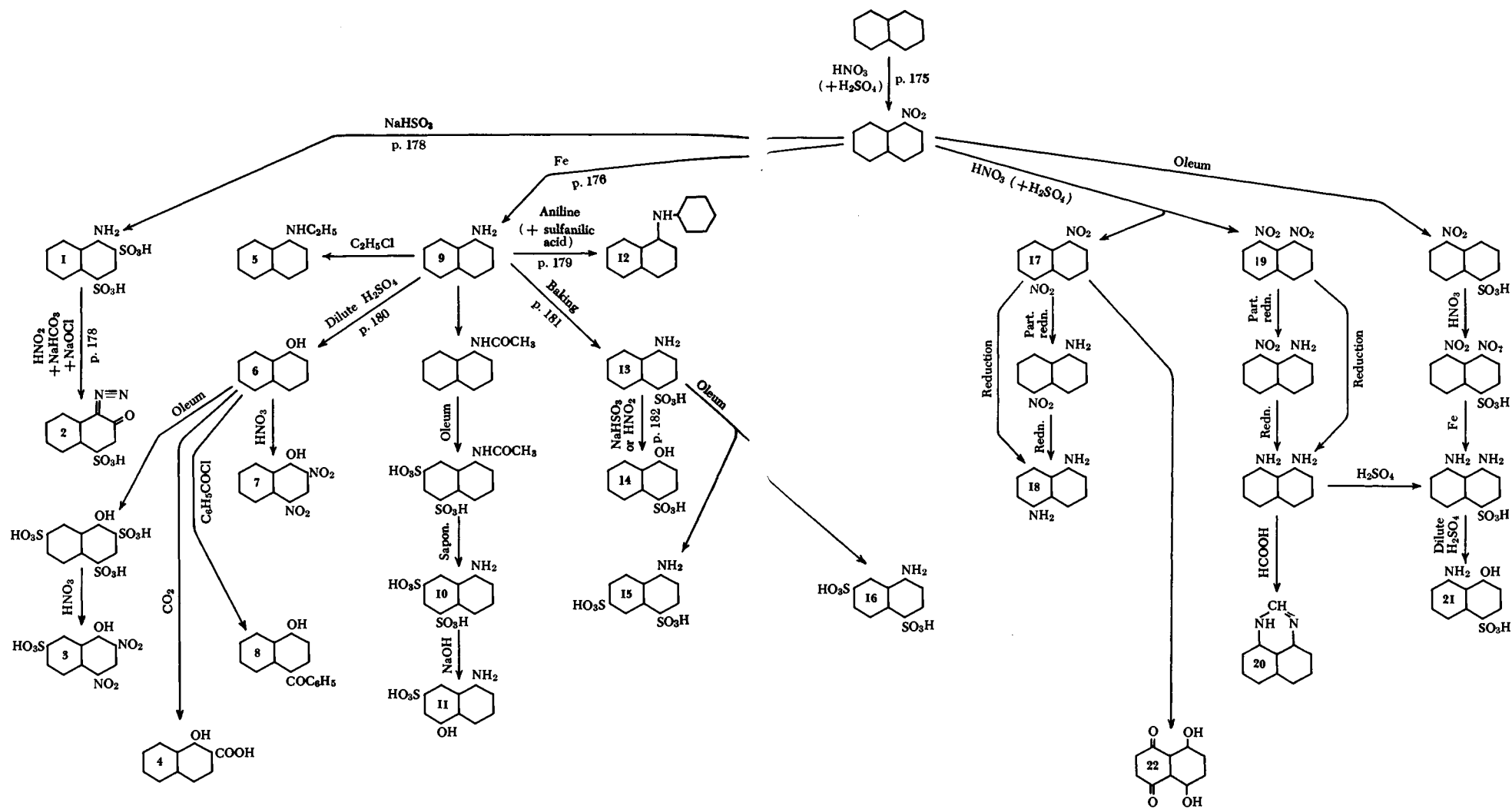

Compound

1. 1-Naphthylamine-2,4-disulfonic acid
2. 1-Diazo-2-naphthol-4-sulfonic acid (cf. No. 29, Table XII)
3. 2,4-Dinitro-1-naphthol-7-sulfonic acid (naphthol yellow S)
4. 1-Hydroxy-2-naphthoic acid
5. Ethyl- α -naphthylamine
6. α -Naphthol (No. 1, Table XI)
7. 2,4-Dinitro-1-naphthol (Martius yellow)
8. 4-Benzoyl-1-naphthol
9. α -Naphthylamine
10. 1-Naphthylamine-5,7-disulfonic acid (No. 3, Table XI)

Principal Use

- Azo dyes
Azo dyes (chrome)
Wool and lake dye
Triphenylmethanes
Triphenylmethanes
Azo dyes, triphenylmethanes, indophenols, indigoids
Nitro dye
Azo dyes (ice colors)
Azo dyes (ice colors), azines, oxazines, vat dyes, and others
Azo dyes

Compound

11. 1-Amino-5-naphthol-7-sulfonic acid (M acid) (No. 4, Table XI)
12. Phenyl- α -naphthylamine
13. 1-Naphthylamine-4-sulfonic acid (naphthionic acid)
14. 1-Naphthylamine-4-sulfonic acid (Neville-Winther acid)
15. 1-Naphthylamine-4,6-disulfonic acid (Dahl acid)
16. 1-Naphthylamine-4,7-disulfonic acid (Dahl acid)
17. 1,5-Dinitronaphthalene
18. 1,5-Diaminonaphthalene
19. 1,8-Dinitronaphthalene
20. Perimidine
21. 1-Amino-8-naphthol-5-sulfonic acid (No. 14, Table XI)
22. Naphthazarin

Principal Use

- Azo dyes (esp. subst.)
Triphenylmethanes
Azo dyes
Azo dyes
Azo dyes
Azo dyes
Sulfur dyes
Azo dyes (subst.)
Sulfur dyes
Azo dyes, indigoids
Azo dyes
Mordant dye

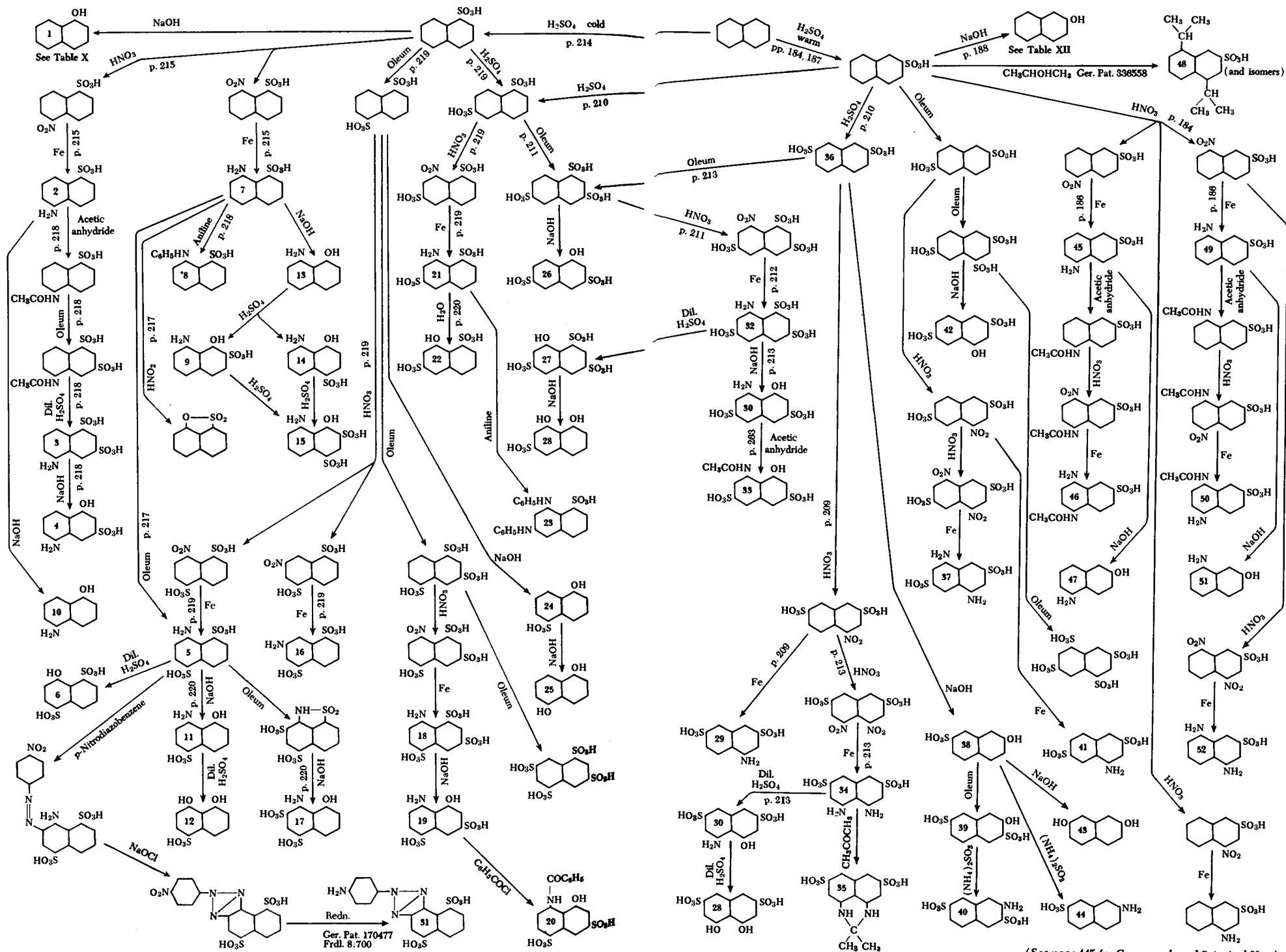

<i>Compound</i>	<i>Principal Use</i>
1. α -Naphthol (No. 6, Table X)	Azo dyes
2. 1-Naphthylamine-5-sulfonic acid	Azo dyes, triphenylmethanes
3. 1-Naphthylamine-5,7-disulfonic acid (No. 10, Table X)	Azo dyes
4. 1-Amino-5-naphthol-7-sulfonic acid (M acid) (No. 11, Table X)	Azo dyes (subst.)
5. 1-Naphthylamine-4,8-disulfonic acid (S acid)	Azo dyes
6. 1-Naphthol-4,8-disulfonic acid (Schoellkopf acid)	Azo dyes
7. 1-Naphthylamine-8-sulfonic acid (peri acid)	Azo dyes
8. 1-Phenyl-naphthylamine-8-sulfonic acid	Azo dyes, sulfur dyes
9. 1-Amino-8-naphthol-7-sulfonic acid	Azo dyes
10. 1-Amino-5-naphthol	Azo dyes
11. 1-Amino-8-naphthol-4-sulfonic acid (S acid)	Azo dyes
12. 1,8-Dihydroxynaphthalene-4-sulfonic acid	Azo dyes
13. 1-Amino-8-naphthol	Azo dyes
14. 1-Amino-8-naphthol-5-sulfonic acid (No. 21, Table X)	Azo dyes
15. 1-Amino-8-naphthol-5,7-disulfonic acid	Azo dyes
16. 2-Aminonaphthalene-4,8-disulfonic acid (C acid)	Azo dyes
17. 1-Amino-8-naphthol-2,4-disulfonic acid (SS acid, Chicago acid)	Azo dyes (subst.)
18. 1-Naphthylamine-4,6,8-trisulfonic acid	Azo dyes
19. 1-Amino-8-naphthol-4,6-disulfonic acid (K acid)	Azo dyes
20. 1-Benzoylamino-8-naphthol-4,6-disulfonic acid (Anthosine acid)	Azo dyes (lake)
21. 1-Naphthylamine-3,8-disulfonic acid	Azo dyes
22. 1-Naphthol-3,8-disulfonic acid (Epsilon acid)	Azo dyes
23. 1,3-Diaminonaphthalene-8-sulfonic acid	Azines (wool fast blue)
24. 1-Naphthol-5-sulfonic acid	Azo dyes (lake)
25. 1,5-Dihydroxynaphthalene	Azo dyes (chrome)
26. 1-Naphthol-3,6-disulfonic acid (Rudolf Gürcke acid)	Azo dyes
27. 1-Naphthol-3,6,8-trisulfonic acid	Azo dyes
28. 1,8-Dihydroxynaphthalene-3,6-disulfonic acid (chromotropic acid)	Azo dyes (chrome)
29. 1-Naphthylamine-3,6-disulfonic acid (Freund acid)	Azo dyes
30. 1-Amino-8-naphthol-3,6-disulfonic acid (H acid)	Azo dyes
31. <i>p</i> -Aminophenyl-1,2-naphthotriazole-4,8-disulfonic acid	Azo dyes (lake)
32. 1-Naphthylamine-3,6,8-trisulfonic acid (Koch acid)	Azo dyes
33. Acetyl-1,8-naphthylenediamine-3,6-disulfonic acid	Azo dyes
34. 1,8-Naphthylenediamine-3,6-disulfonic acid	Azo dyes
35. Acetyl-1,8-naphthylenediamine-3,6-disulfonic acid	Azo dyes
36. Naphthalene-2,7-disulfonic acid	Naphthalene green
37. 1,5-Diaminonaphthalene-3,7-disulfonic acid	Azo dyes (subst.)
38. 2-Naphthol-7-sulfonic acid (F acid)	Azo dyes
39. 2-Naphthol-3,7-disulfonic acid	Azo dyes
40. 2-Naphthylamine-3,7-disulfonic acid	Azo dyes
41. 1-Naphthylamine-3,7-disulfonic acid	Azo dyes
42. 1-Naphthol-3,7-disulfonic acid	Azo dyes
43. 2,7-Dihydroxynaphthalene	Azo dyes, oxazines
44. 2-Naphthylamine-7-sulfonic acid (No. 31, Table XII)	Azo dyes
45. 1-Naphthylamine-6-sulfonic acid (Cleve acid)	Azo dyes
46. 4-Acetamino-1-naphthylamine-7-sulfonic acid	Azo dyes
47. 1-Amino-6-naphthol	Azo dyes
48. Diisopropyl-naphthalenesulfonic acid (Nekal)	Emulsifying and wetting agent
49. 1-Naphthylamine-7-sulfonic acid (Cleve acid)	Azo dyes
50. 4-Acetamino-1-naphthylamine-6-sulfonic acid	Azo dyes
51. 1-Amino-7-naphthol	Azo dyes
52. 1,5-Diaminonaphthalene-3-sulfonic acid	Azo dyes

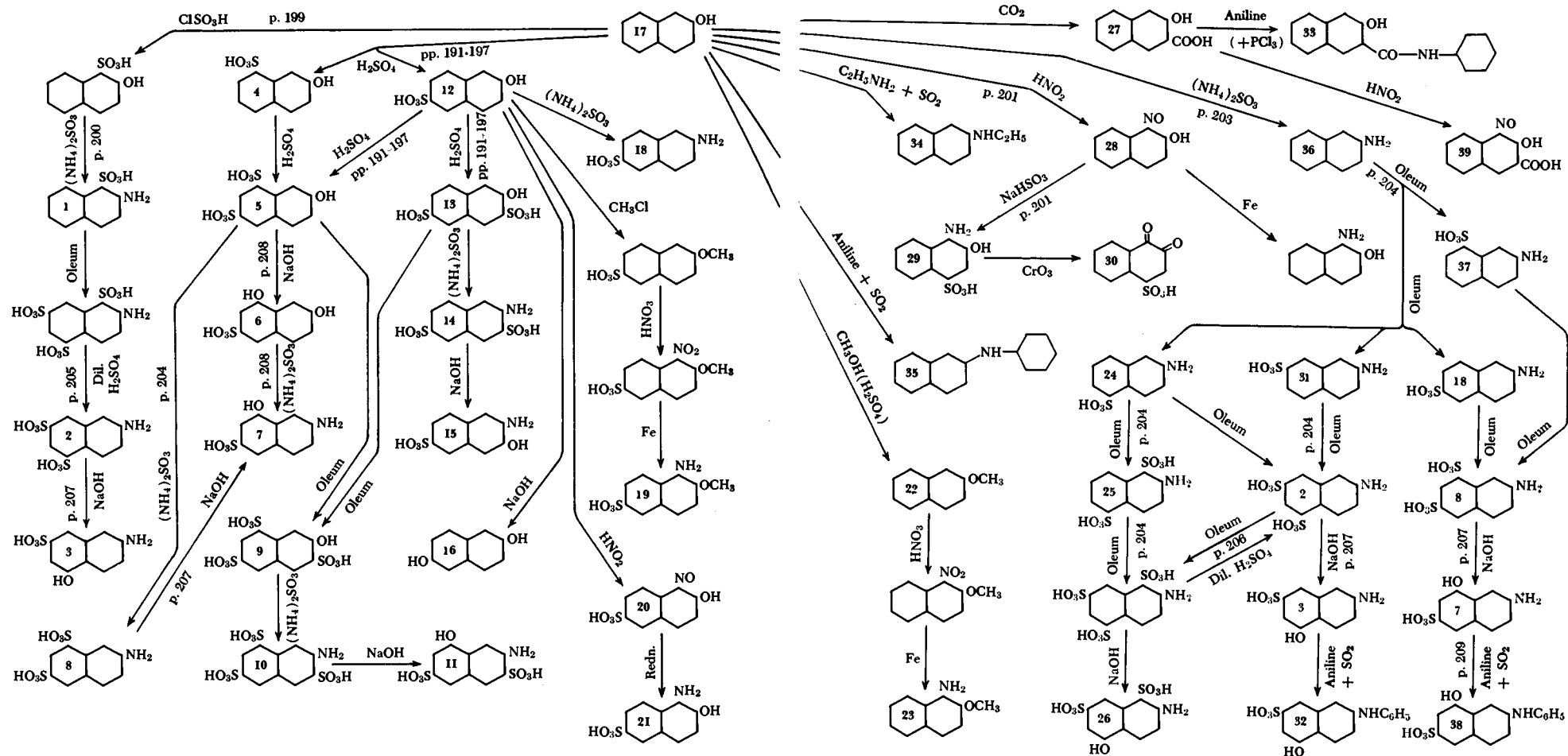
**Compound**

1. 2-Naphthylamine-1-sulfonic acid
2. 2-Naphthylamine-5,7-disulfonic acid
3. 2-Amino-5-naphthol-7-sulfonic acid (J acid)
4. 2-Naphthol-8-sulfonic acid (crocein acid)
5. 2-Naphthol-6,8-disulfonic acid (C salt)
6. 2,8-Dihydroxynaphthalene-6-sulfonic acid
7. 2-Amino-8-naphthol-6-sulfonic acid (Camma acid)
8. 2-Naphthylamine-6,8-disulfonic acid (amino-C salt)
9. 2-Naphthol-3,6,8-trisulfonic acid
10. 2-Naphthylamine-3,6,8-trisulfonic acid
11. 2-Amino-8-naphthol-3,6-disulfonic acid (Camma-disulfonic acid)
12. 2-Naphthol-6-sulfonic acid (Schaeffer acid)
13. 2-Naphthol-3,6-disulfonic acid (R salt)
14. 2-Naphthylamine-3,6-disulfonic acid (amino-R salt)
15. 2-Amino-3-naphthol-6-sulfonic acid
16. 2,6-Dihydroxynaphthalene
17. β -Naphthol
18. 2-Naphthylamine-6-sulfonic acid (Brönnner acid)
19. 1-Amino-2-methoxynaphthalene-6-sulfonic acid
20. 1-Nitroso-2-naphthol-6-sulfonic acid
21. 1-Amino-2-naphthol-6-sulfonic acid (Eikonogen)

Principal Use

- Azo dyes (lake)
 Azo dyes
 Azo dyes (subst.)
 Azo dyes
 Azo dyes
 Azo dyes
 Azo dyes
 Azo dyes
 Azo dyes
 Azo dyes
 Azo dyes
 Azo dyes
 Azo dyes, triphenylmethanes
 Azo dyes
 Azo dyes
 Azo dyes
 Azo dyes, triphenylmethanes, oxazines
 Azo dyes
 Azo dyes
 Azo dyes
 Lake (as Fe salt)
 Photography (developer), oxazines

Compound

22. β -Naphthol methyl ether
23. 1-Amino-2-naphthol methyl ether
24. 2-Naphthylamine-5-sulfonic acid
25. 2-Naphthylamine-1,5-disulfonic acid
26. 2-Amino-5-naphthol-1,7-disulfonic acid (J disulfonic acid)
27. 2-Hydroxy-3-naphthoic acid
28. 1-Nitroso-2-naphthol
29. 1-Amino-2-naphthol-4-sulfonic acid (cf. No. 2, Table X)
30. β -Naphthoquinonesulfonic acid
31. 2-Naphthylamine-7-sulfonic acid (No. 44, Table XI)
32. 2-Phenylamino-5-naphthol-7-sulfonic acid (phenyl-J acid)
33. 2-Hydroxy-3-naphthamide (naphthol AS)
34. Ethyl- β -naphthylamine
35. Phenyl- β -naphthylamine
36. β -Naphthylamine
37. 2-Naphthylamine-8-sulfonic acid (Badische acid)
38. 2-Phenylamino-8-naphthol-6-sulfonic acid (phenyl-gamma acid)
39. 1-Nitroso-2-hydroxy-3-naphthoic acid

Principal Use

- Perfume
 Azo dyes
 Azo dyes
 Azo dyes
 Azo dyes
 Azo dyes (lake)
 Lake, steam green (Fe salt)
 Azo dyes (chrome), oxazines
 Oxazines, sulfur dyes
 Azo dyes
 Azo dyes (subst.)
 Azo dyes (pigment and ice colors)
 Azines
 Azines
 Azo dyes, triphenylmethanes, vat dyes
 Azo dyes (lake)
 Azo dyes
 Lake (as Fe salt)

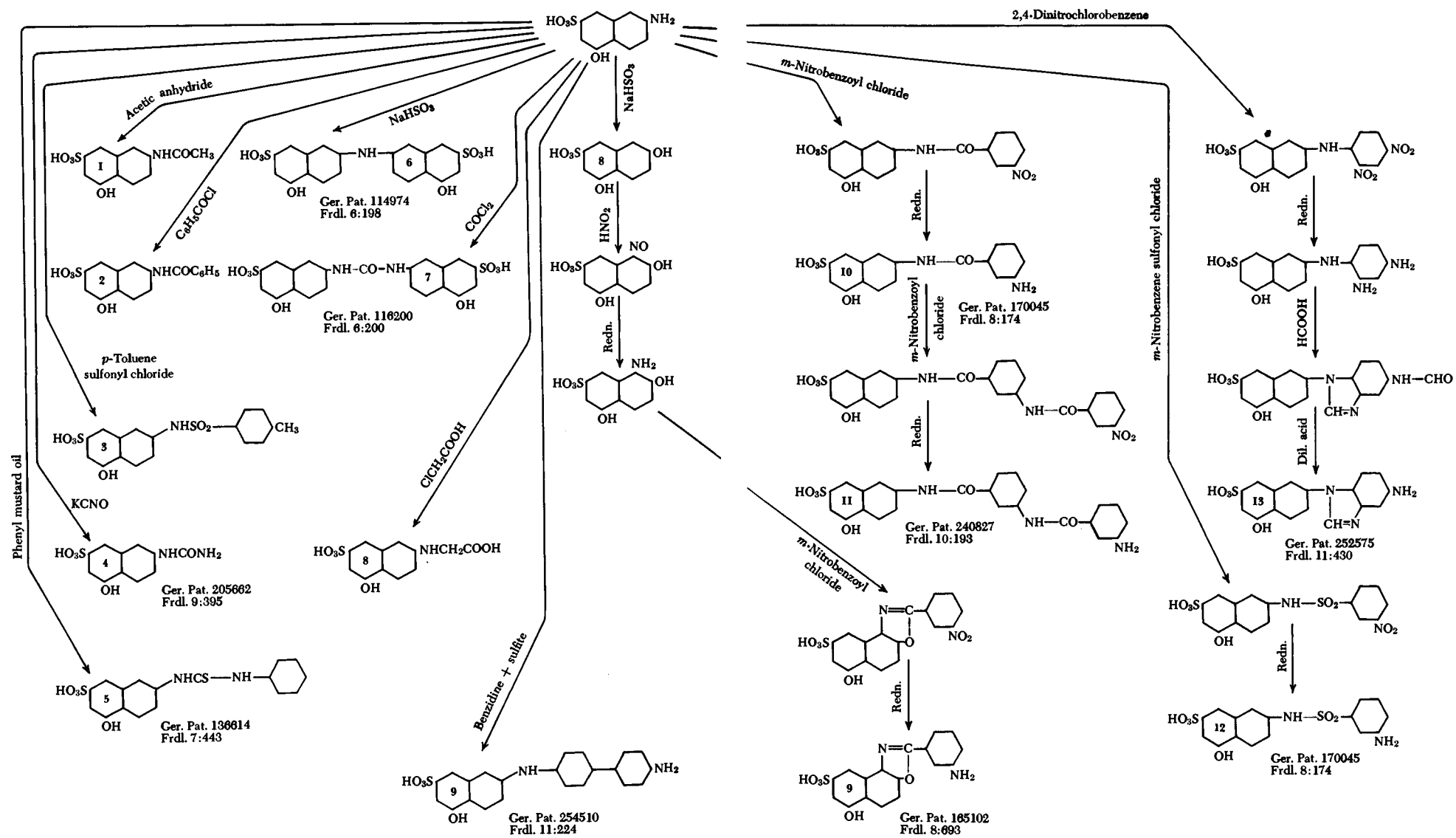

Compounds I to 13 are all used as end or middle components for substantive cotton dyes.
(continued in Table XIIIb)

TABLE XIIIb. Derivatives of 2-Amino-5-naphthol-7-sulfonic Acid (J Acid) (continued from Table XIIIa)

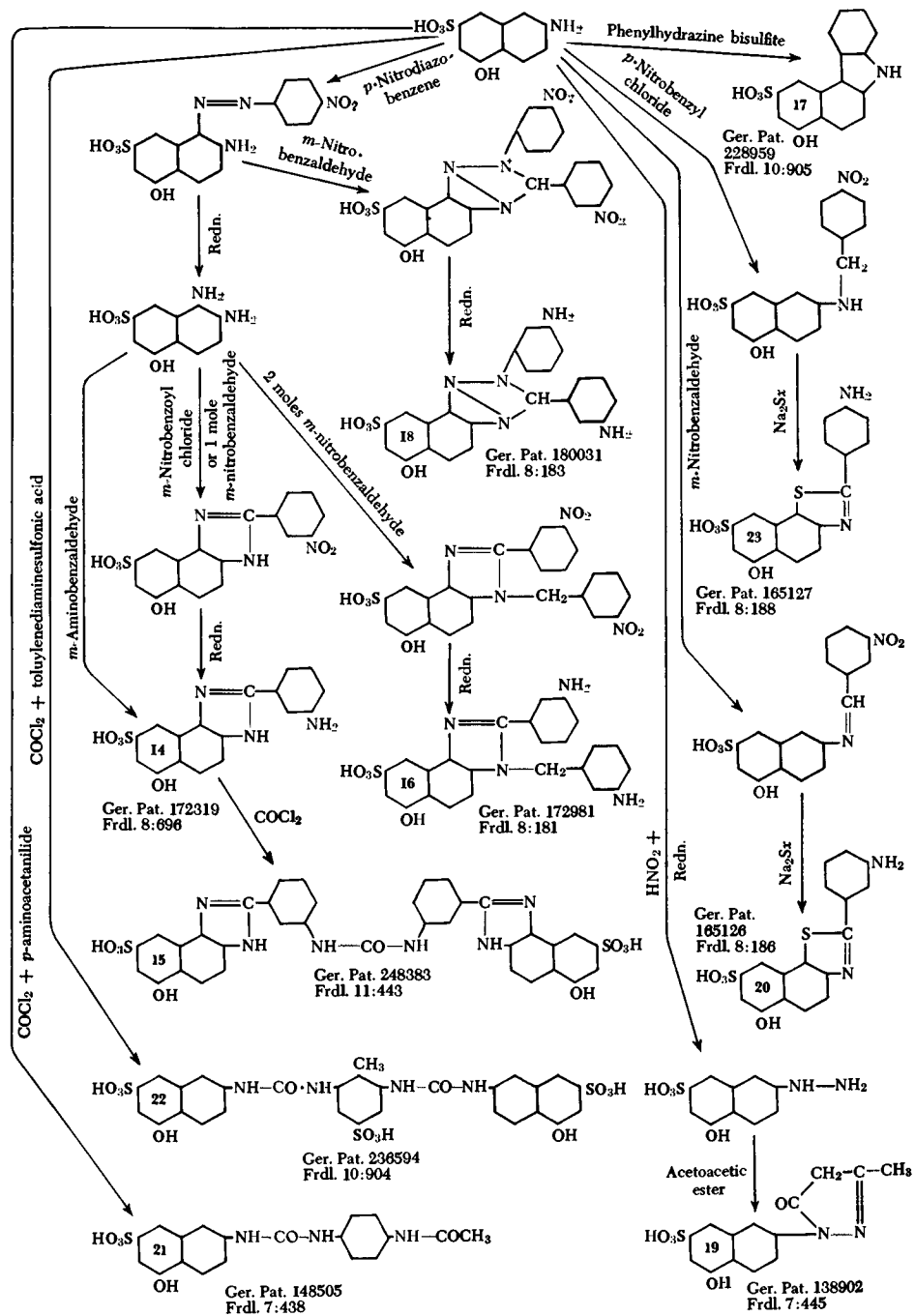

Compounds 14 to 23 are all used as end or middle components for substantive cotton dyes.

TABLE XIV. Derivatives of 2-Naphthylamine-5,7-disulfonic Acid

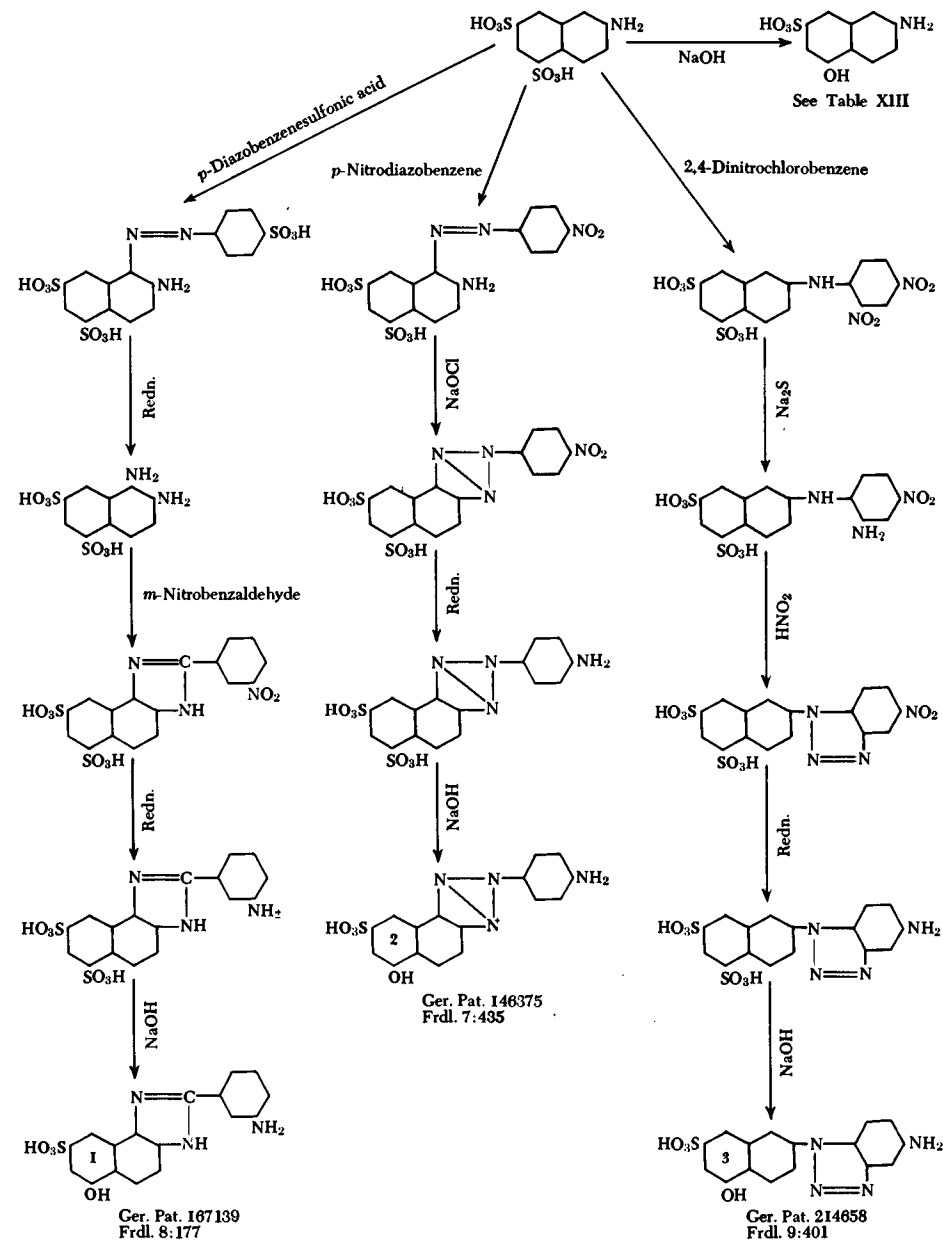

Compounds 1 to 3 are used as end or middle components for substantive cotton dyes.

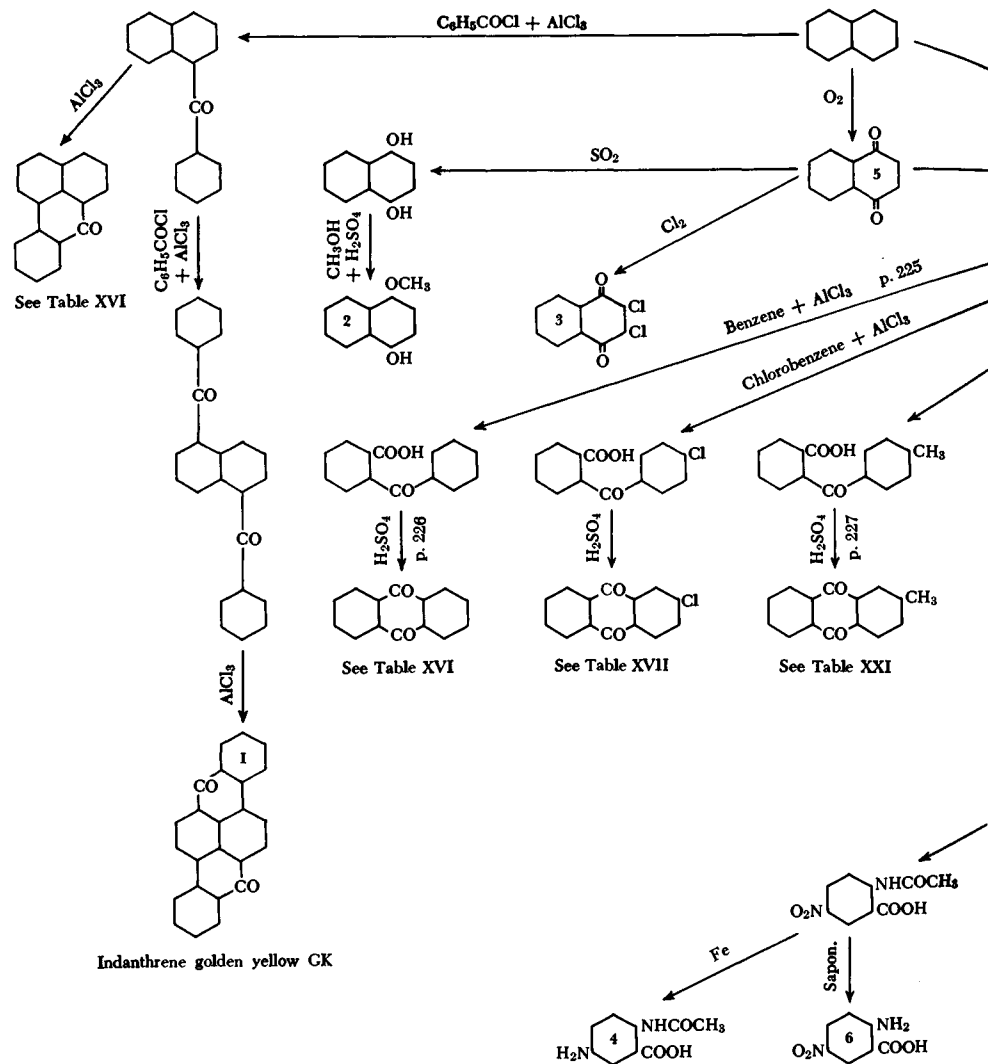

Compound

1. Dibenzopyrenequinone (indanthrene golden yellow CK) (No. 5, Table XVI)
2. α -Naphthohydroquinone monomethyl ether
3. 2,3-Dichloro- α -naphthoquinone
4. 5-Aminoacetylanthranilic acid
5. α -Naphthoquinone
6. 5-Nitroanthranilic acid
7. 5-Sulfoanthranilic acid
8. 2,4-Dihydroxyquinoline
9. 5-Chloroanthranilic acid

Principal Use

- Vat dye
- Azo dyes, indigoids
- Vat dyes
- Azo dyes, acridones
- Vat dyes
- Azo dyes
- Azo dyes
- Azo dyes (lake)
- Azo dyes, acridones

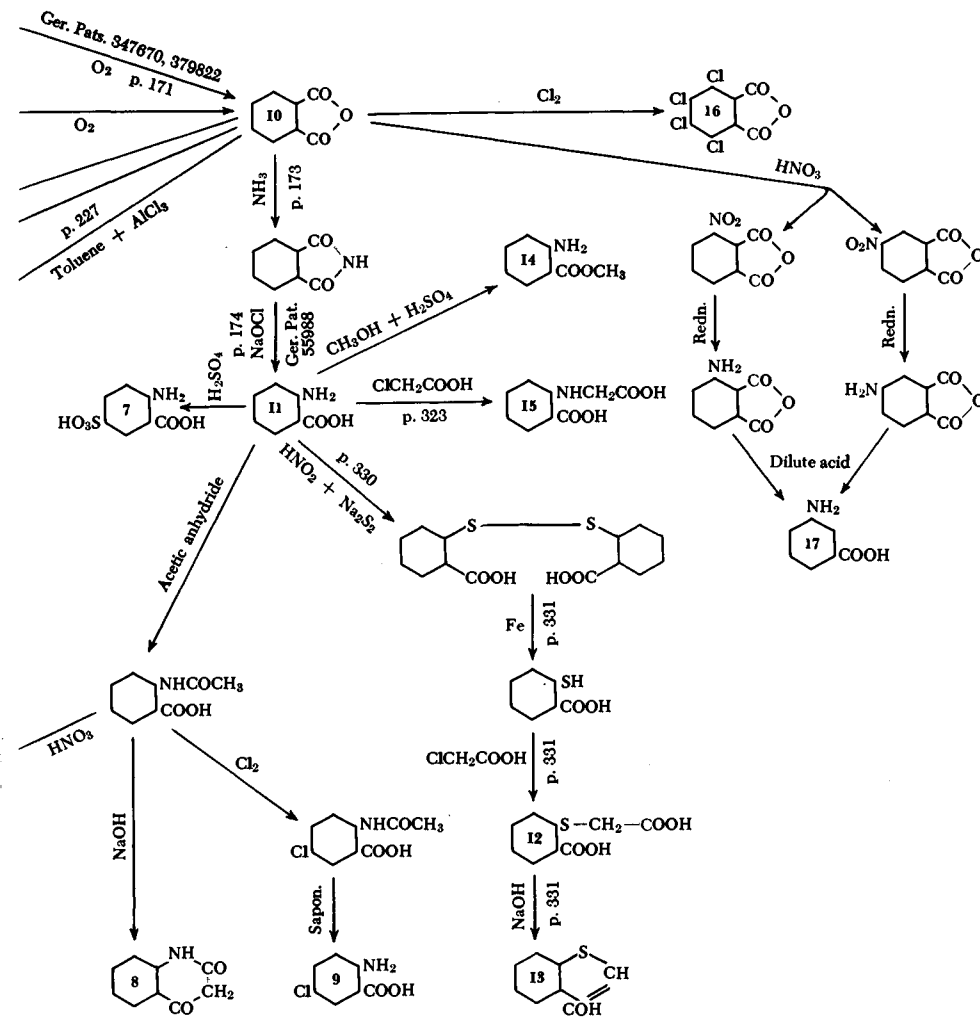

Compound

10. Phthalic anhydride
11. Anthranilic acid
12. o -Carboxyphenylthioglycolic acid
13. 3-Hydroxythionaphthene
14. Methyl anthranilate
15. Phenylglycine- o -carboxylic acid
16. Tetrachlorophthalic anhydride
17. m -Aminobenzoic acid

Principal Use

- Phthaleins, anthraquinone, sulfur dyes, softeners, resins
- Azo dyes, acridones
- Thioindigos
- Thioindigos
- Perfume, azo dyes
- Indigo
- Phthaleins
- Azo dyes

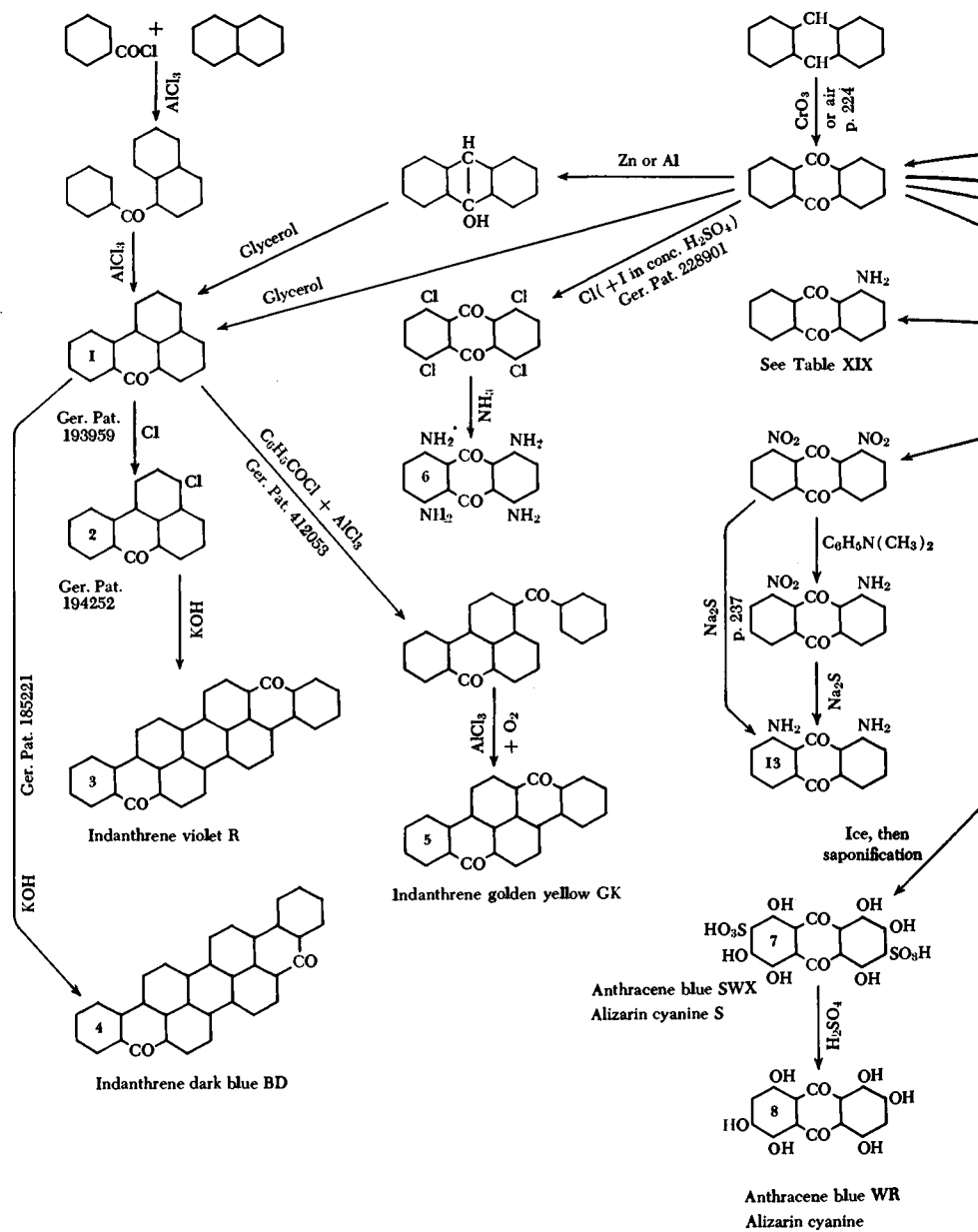

Compound

1. Benzanthrone
2. *bz*-1-Chlorobenzanthrone
3. Isodibenzanthrone (indanthrene violet R)
4. Dibenzanthrone (indanthrene dark blue BO)
5. Dibenzopyrenequinone (indanthrene golden yellow GK) (No. I, Table XV)
6. 1,4,5,8-Tetraaminoanthraquinone
7. Anthracene blue SWX (alizarin cyanine S)

Principal Use

- Vat dyes
 Vat dyes
 Vat dye
 Vat dye
 Vat dye
 Acetate dye
 Mordant dye

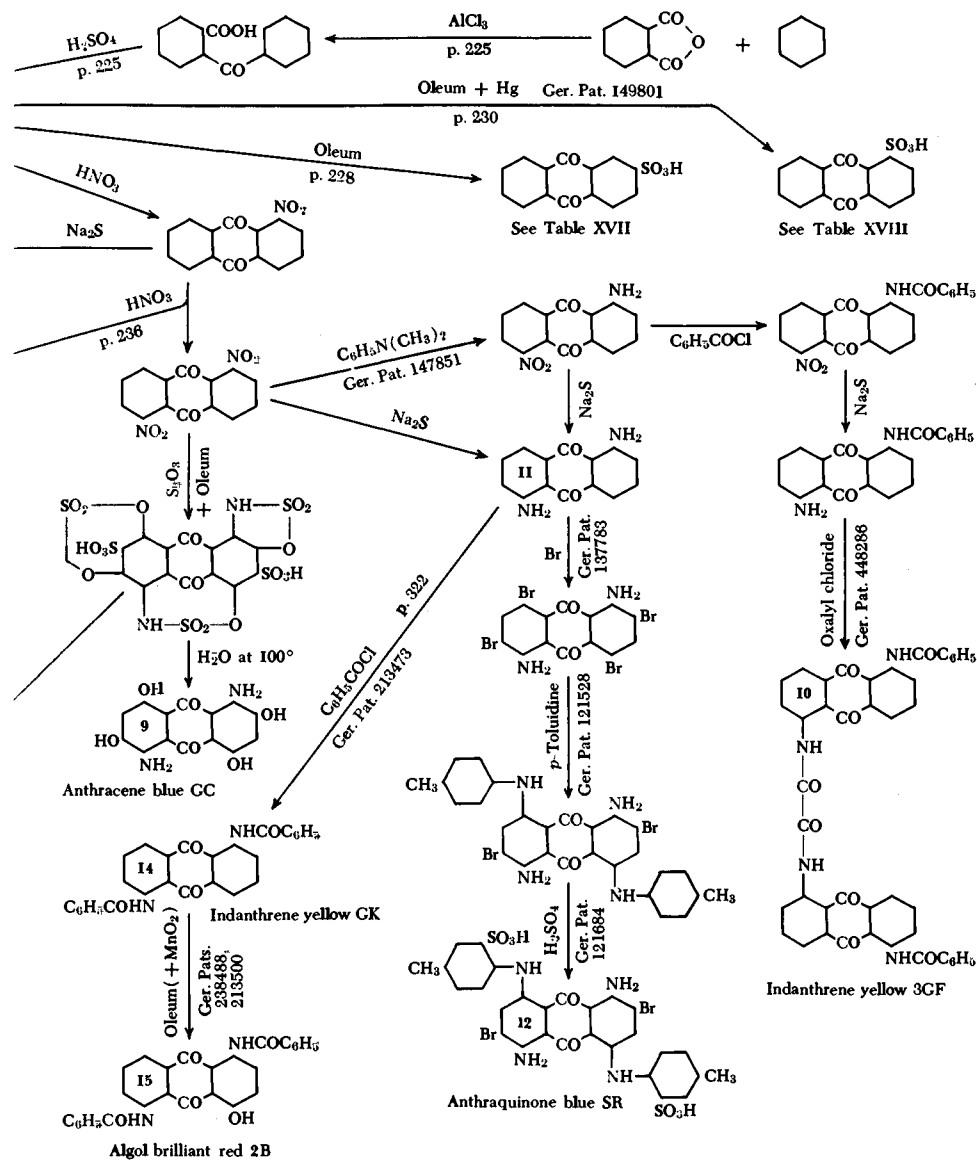

Compound

8. Anthracene blue WR (alizarin cyanine)
9. Anthracene blue GC
10. Indanthrene yellow 3 GF
11. 1,5-Diaminoanthraquinone
12. Anthraquinone blue SR
13. 1,8-Diaminoanthraquinone
14. Indanthrene yellow GK
15. Algal brilliant red 2 B

Principal Use

- Mordant dye
 Mordant dye
 Vat dye
 Vat dyes, acid wool dyes
 Acid wool dye
 Vat dyes, acid wool dyes
 Vat dye
 Vat dye

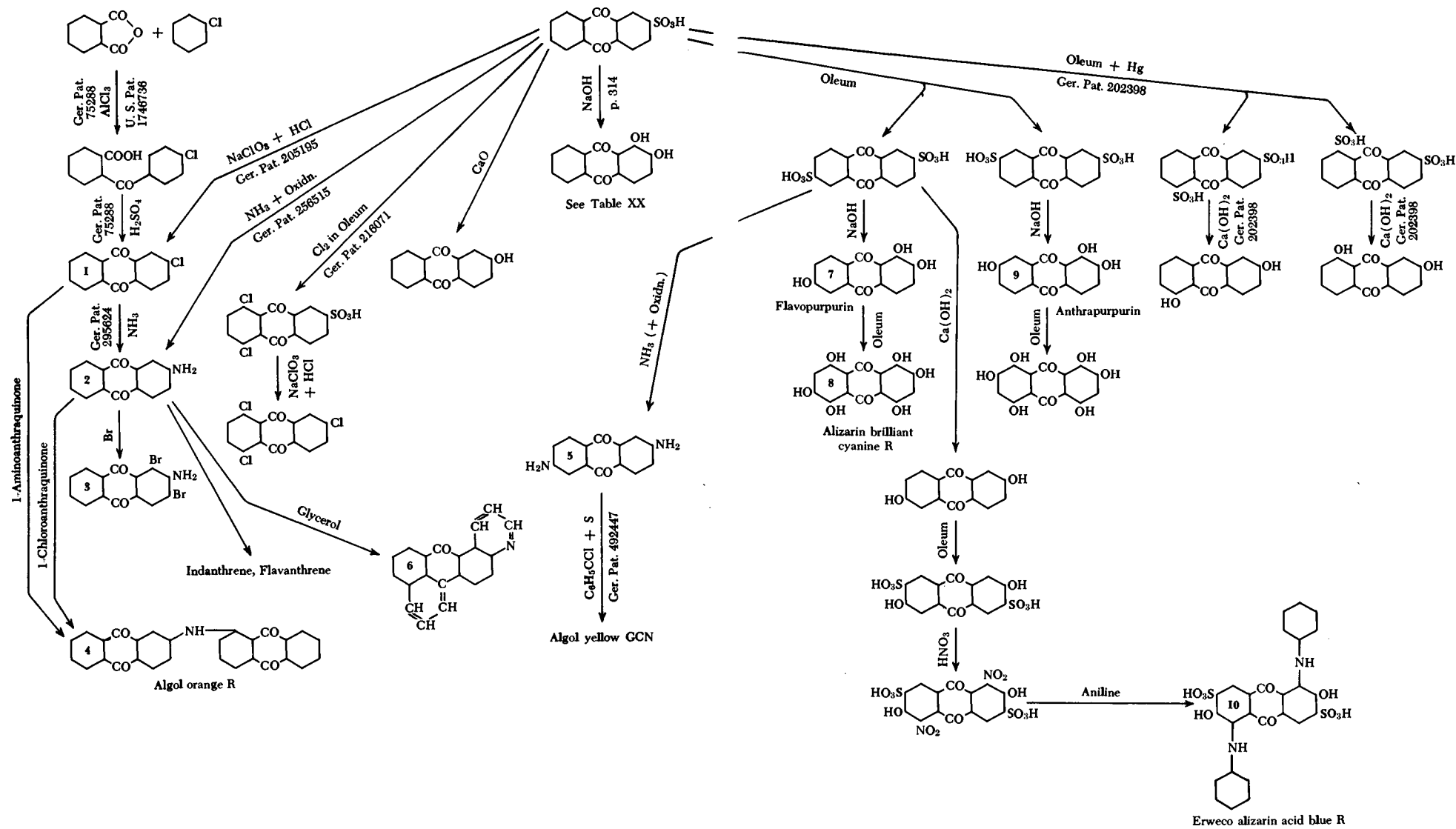

Compound	Principal Use
1. 2-Chloroanthraquinone	Vat dyes
2. 2-Aminoanthraquinone	Vat dyes
3. 1,3-Dibromo-2-aminoanthraquinone	Vat dyes
4. Algol orange	Vat dye
5. 2,6-Diaminoanthraquinone	Vat dyes
6. Benzanthroquinoline	Vat dyes

Compound	Principal Use
7. 1,2,8-Trihydroxyanthraquinone (flavopurpurin)	Mordant dyes
8. 1,2,4,5,6,8-Hexahydroxyanthraquinone (alizarin brilliant cyanine R)	Mordant dye
9. 1,2,7-Trihydroxyanthraquinone (anthrapurpurin)	Mordant dye
10. Erwego alizarin acid blue R	Acid wool dye

Compound	Principal Use
7. 1,2,8-Trihydroxyanthraquinone (flavopurpurin)	Mordant dyes
8. 1,2,4,5,6,8-Hexahydroxyanthraquinone (alizarin brilliant cyanine R)	Mordant dye
9. 1,2,7-Trihydroxyanthraquinone (anthrapurpurin)	Mordant dye
10. Erwego alizarin acid blue R	Acid wool dye

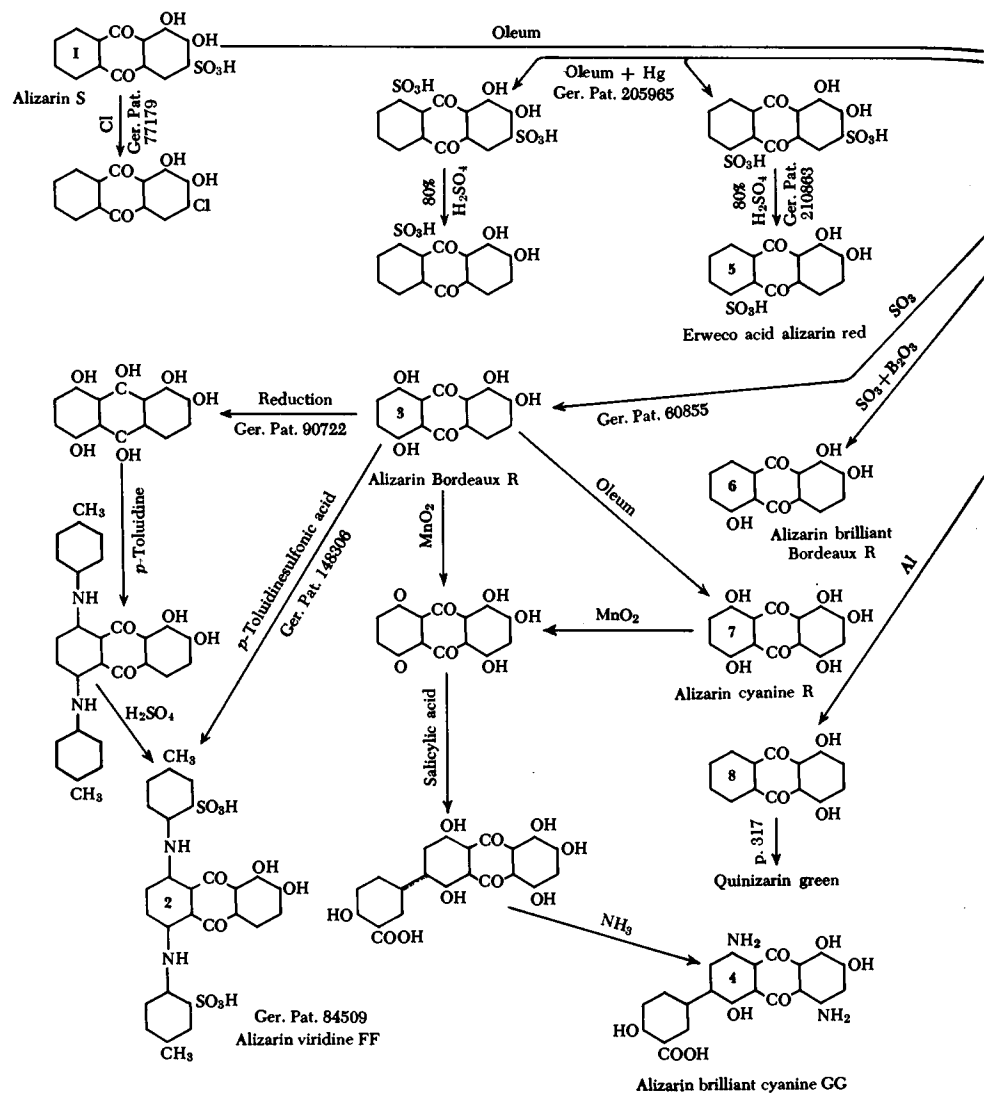
**Compound**

- 1,2-Dihydroxyanthraquinone-3-sulfonic acid (alizarin S)
- Alizarin viridine FF
- 1,2,5,8-Tetrahydroxyanthraquinone (alizarin Bordeaux R)
- Alizarin brilliant cyanine GC
- 1,2-Dihydroxyanthraquinone-5-sulfonic acid (Erweco acid alizarin red)
- 1,2,5-Trihydroxyanthraquinone (alizarin brilliant Bordeaux R)
- 1,2,4,5,8-Pentahydroxyanthraquinone (alizarin cyanine R)
- 1,4-Dihydroxyanthraquinone (quinizarin)

Principal Use

- Mordant dye
 Acid wool dye
 Mordant dye
 Mordant dye
 Mordant dye
 Mordant dye
 Acid wool dyes

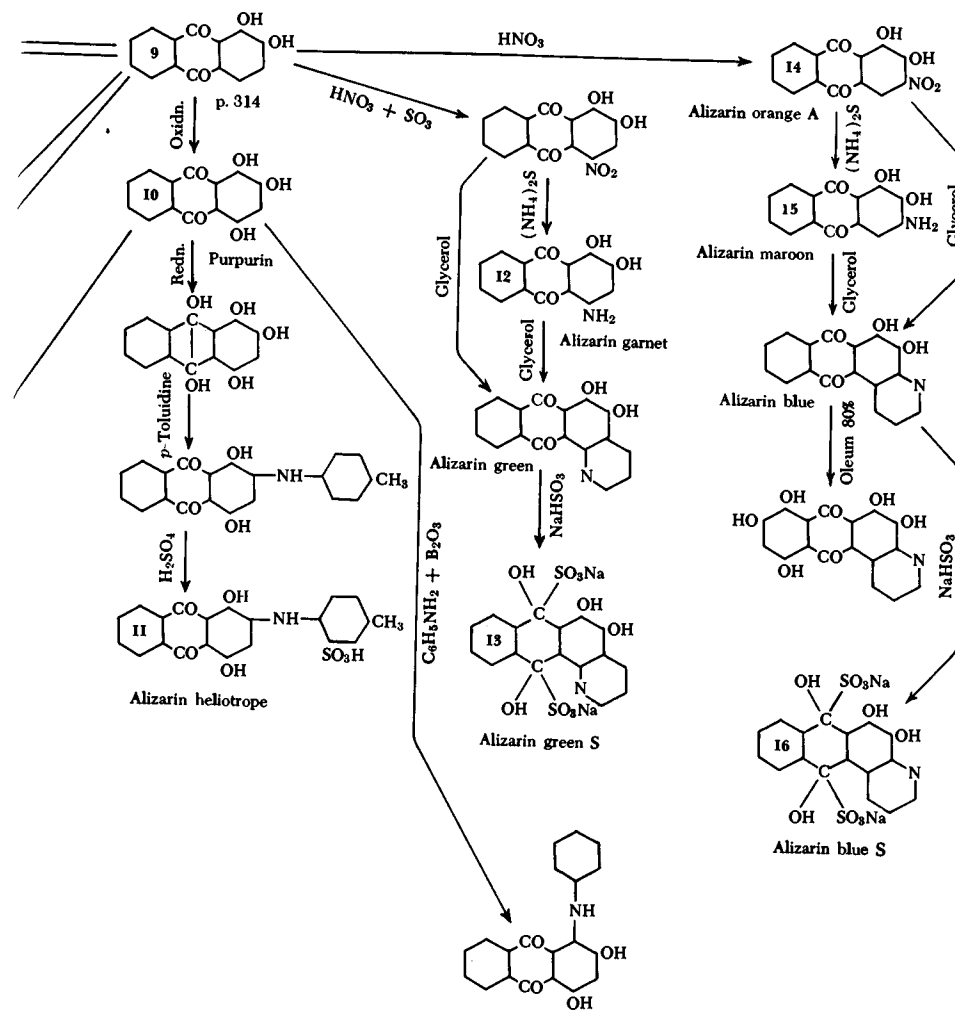
**Compound**

9. 1,2-Dihydroxyanthraquinone (alizarin)
- 1,2,4-Trihydroxyanthraquinone (alizarin)
- Alizarin heliotrope
- 4-Amino-1,2-dihydroxyanthraquinone (alizarin garnet)
- Alizarin green S
- 3-Nitro-1,2-dihydroxyanthraquinone (alizarin orange A)
- 3-Amino-1,2-dihydroxyanthraquinone (alizarin maroon)
- Alizarin blue S

Principal Use

- Mordant dye
 Acid wool dye
 Acid wool dye
 Mordant dye
 Mordant dye
 Mordant dye
 Mordant dye

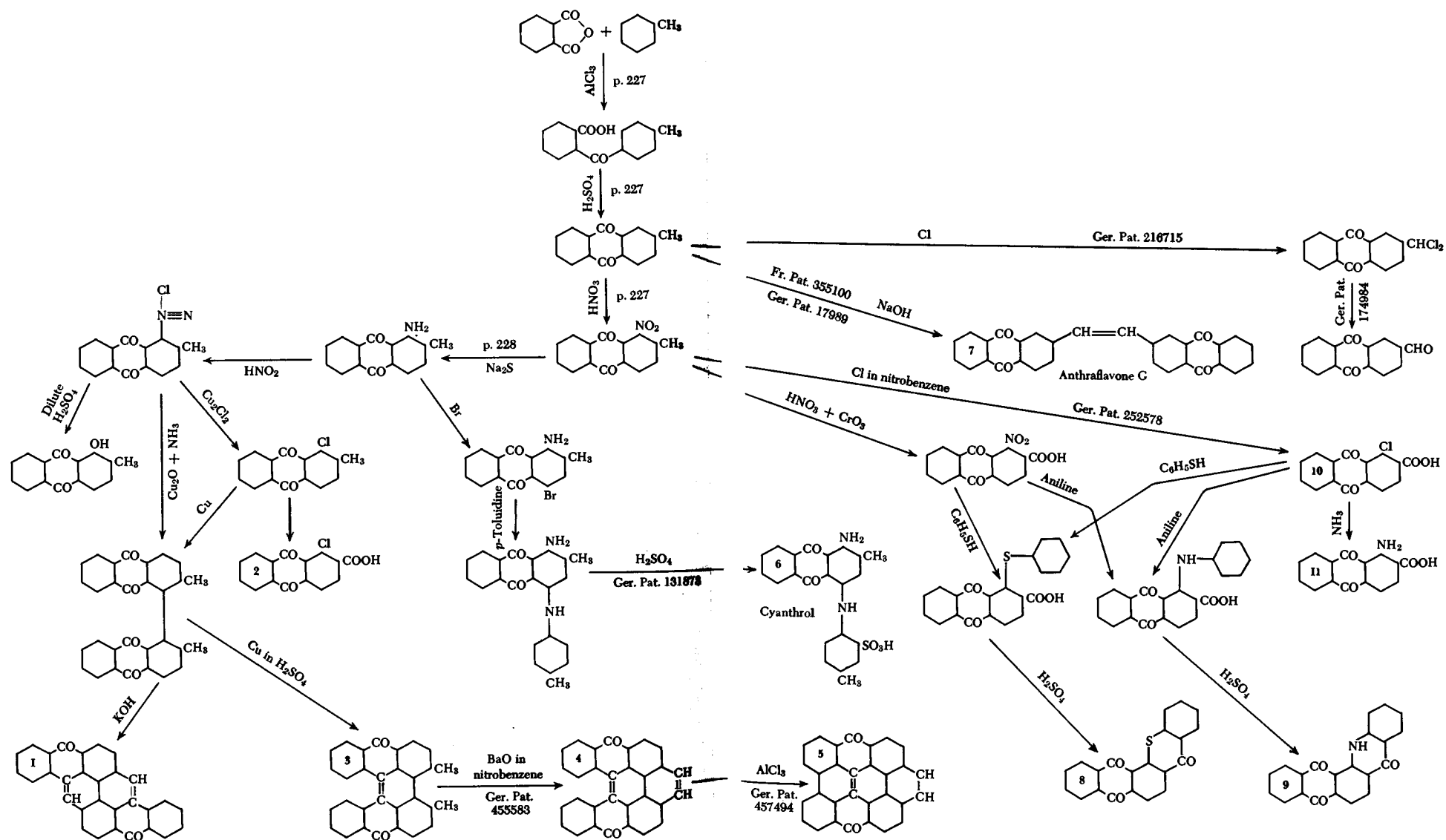

Indanthrene golden orange G

Compound

1. Pyranthrone (indanthrene golden orange G)
2. 1-Chloroanthraquinone-2-carboxylic acid
3. Dimethyl-*meso*-benzodanthrone
4. *allo-meso*-Naphthodanthrone
5. *meso*-Anthradanthrone
6. Cyananthrol

Principal Use

- Vat dye
 Vat dyes (acridones)
 Vat dyes
 Vat dyes
 Vat dyes
 Acid wool dye

Compound

7. Anthraflavone G
8. Anthraquinonethioxanthone
9. Anthraquinonescrindone (No. 1, Table XVIII, and No. 4, Table XIX)
10. Same as No. 2
11. 1-Aminoanthraquinone-2-carboxylic acid

Principal Use

- Vat dye
 Vat dyes
 Vat dyes
 Vat dyes (acridones)

SUBJECT INDEX

Italicized page numbers refer to sections describing the synthesis of the substance in question.

A

- Absorption spectrum, 48
Accounting, 371, 378
Acenaphthene, 1
1-Acetamino-8-naphthol-3,6-disulfonic acid, 263
p-Acetaminophenol, 52
Acetanilide, 93, 130, 131
Acetoacetanilide, 140, 267
Aceto-*p*-phenylenediamine, 132
 diazotization, 245
Acet-*o*-toluidide, 9, 67
Acet-*p*-toluidide, 52
Acetyl-H acid, *see* 1-Acetamino-8-naphthol-3,6-disulfonic acid
Acid IV (C acid), *see* 2-Naphthylamine-4,8-disulfonic acid
Acid anthracene red G, 124, 294
Acid orange A, 262, 378
Air as oxidizing agent, 8
Aldehyde group, introduction, 10
Algol yellow WG, 323
Alizarin, 90, 314
Alizarin cyanine green G, 317
Alizarin pure blue B, 232
Alizarin saphirol B and SE, 319
Alkali fusion
 apparatus, 86, 87
 general, 88
 oxidative, 90
 partial, 89
 side reactions, 89
Alkaline earth salts, 58
Alkoxy groups, introduction, 8
Alloys, iron, 363, 364
Alsace green J, 201
Aluminum, 364
Aluminum chloride, 60, 226, 227
Aluminum chloride-pyridine, 60
Aluminum sodium chloride, 60, 223
Amidonaphthol red G, 263
Amines
 determination, 386
 separation, 27
p-Aminoacetanilide, 132
1-Aminoanthraquinone, 59, 231
2-Aminoanthraquinone, 8, 58, 229, 321
 technical observations, 229
1-Aminoanthraquinone-2-sulfonic acid, 59
p-Aminoazobenzene, 270
 diazotization, 245
1-Amino-2-bromo-4-*p*-toluidinoanthraquinone, 233
1-Amino-2,4-dibromoanthraquinone, 60, 233
1-Amino-2,4-dimethoxy-5-chlorobenzene, 98
p-Aminodimethylaniline, 311
p-Aminodiphenylamine, diazotization, 249
Aminodiphenylaminesulfonic acid, 100
1-Amino- γ acid, *see* 1,2-Diamino-8-naphthol-6-sulfonic acid
Amino groups
 introduction, 8
 orienting power, 52
 protection by acylation, 67
Amino-H acid, *see* 1,7-diamino-8-naphthol-3,6-disulfonic acid
1-Amino-2-methylanthraquinone, 228
Aminonaphthalene-, *see* Naphthylamine
1-Amino-8-naphthol-2,4-disulfonic acid, 165, 207, 210

- 1-Amino-8-naphthol-3,6-disulfonic acid, 3, 211, 213, 214
 acetylation, 263
 determination, 389
 dyes from, 263, 288, 291
 solubility, 214
p-toluenesulfonyl derivative, 407
- 1-Amino-2-naphthol-4-sulfonic acid, 80, 85, 178, 201
 diazotization, 248
- 1-Amino-5-naphthol-2-sulfonic acid, 218
- 1-Amino-8-naphthol-4-sulfonic acid, 217, 220
- 2-Amino-5-naphthol-7-sulfonic acid, 204, 207
- 2-Amino-8-naphthol-6-sulfonic acid, 204, 207, 208, 286
- Aminonaphtholsulfonic acids, determination, 389
- p*-Aminophenol, 78
- 2-Aminophenol-4,6-disulfonic acid, 153
- 4-Aminophenol-3,5-disulfonic acid, 202
- Aminophenols, separation, 30
- p*-Aminophenyloxamic acid, 94
- Aminophenyltolylaminesulfonic acid, 100
- p*-Aminosalicylic acid, 156
- Aminosulfonic acids
 determination, 388
 separation, 32
- Ammonia, temperature-pressure curves, 92
- Analysis of commercial dyes, 399 ff.
- Analysis of dyes, Knecht method, 392
- Analytical procedures, 383 ff.
- Aniline
 by catalytic reduction, 76
 diazotization, 243, 259
 from chlorobenzene, 76
 from nitrobenzene, 75
 solubility in water, 75
 technical observations, 75
- Aniline black, 76
- Aniline-2,5-disulfonic acid, 106
- Aniline-*o*-sulfonic acid, 122
- Aniline-*m*-sulfonic acid, 120
- Aniline-*p*-sulfonic acid, 126
- o*-Anisidine, 93, 99
- Anisole, 8
- Anthracene, 1, 224
- Anthranilic acid, 174, 323, 330
- Anthraquinone, 224, 226
 halogen derivatives, 60
 hydroxylamine derivatives, 58
 hydroxyl derivatives, 58
 monosulfonic acid derivatives, 56
 sulfonation, 56, 228, 230, 234
- Anthraquinone-1,5-disulfonic acid, 57, 234
- Anthraquinone-1,6-disulfonic acid, 57
- Anthraquinone-1,7-disulfonic acid, 57
- Anthraquinone-1,8-disulfonic acid, 57, 234
- Anthraquinone-2,6-disulfonic acid, 56
- Anthraquinone-2,7-disulfonic acid, 56
- Anthraquinone dyes, 314 ff.
- Anthraquinone series, orientation, 56
- Anthraquinone-1-sulfonic acid, 56, 230
- Anthraquinone-2-sulfonic acid, 56, 228, 314
- 1-Anthraquinonyloxamic acid, 231
- Anthrarufin, *see* 1,5-Dihydroxy-anthraquinone
- Antimony-lead, 365
- Antipyrene, 129
- Apparatus, materials for, 16
- Aqua regia, 67
- Armstrong-Wynne rule, 54
- Arsenic acid, 58, 229
- Arylsulfonamides, 52
- Auramine G, 299
- Auramine OO, 298
- Aurine dyes, 155
- Autoclaves, 350 ff.
 general rules on use, 361
- Azine dyes, 99
- Azobenzene, 78, 125
- Azobenzenedisulfonic acid, 123

- Azo dark green, 289
- Azo dyes
 general, 239-262
 isolation, 257 ff.
 reductive splitting, 402
 titration with $TiCl_3$, 394
- Azo flavine FF, 272
- Azosalicylic acid, 295
- Azoxybenzene, 78
- Azoxybenzenesulfonic acid, 123
- Azo yellow, 273, 275
- Azo yellow G, 276

B

- Bakelite, 368
- Baking process, 52, 84, 126, 181
 apparatus, 181
- Béchamp-Brimmeyr reduction, 77
- Benzal chloride, 158
 technical observations, 159
- Benzaldehyde, 158
- Benzaldehydedisulfonic acid, 303
- Benzanthrone, 60
- Benzene, 1
- Benzene-*m*-disulfonic acid, 143
- Benzene hexachloride, 62
- Benzene compounds, 62 ff.
- Benzenesulfonic acid, 80
 Bakelite process, 82
- Benzidine, 124
 by electrolytic reduction, 126
 technical observations, 126
 tetrazotization, 261
- Benzidine-3,3'-dicarboxylic acid, 164
- Benzidine-2,2'-disulfonic acid, 123, 294
 technical observations, 124
- Benzidine dyes, 285 ff.
- Benzidine rearrangement, 99
- Benzidine-salicylic acid intermediate, 285
- Benzoic acid, 159
- Benzo light blue 2GL, 279
- Benzo light grey BL, analysis, 407
- Benzopurpurin 4B, 294
- Benzotrithloride, 159
- o*-Benzoylbenzoic acid, 225

- Benzoyl chloride, 60
- Benzopyrenequinone, 224
- Benzyl alcohol, 159
- Benzyl chloride, 159
- Biebrich scarlet dyes, 279
- Bindschedler's green, 312
- Biphenyl, 61
- Bismarck brown G and R, 282
- Blending, 377
- Bohn-Schmidt reaction, 60
- Boiling point determination, 40
- Boiling rods, 22
- Boiling stones, 22
- Boric acid, 59
 esters, 59
- Brilliant indigo 4C, 164
- Brilliant sulfo flavine, 409
- Brilliant yellow, 283
- Bromination, 67
- Bronze, 364
- Bucherer reaction, 8, 182, 201, 203, 209

C

- C acid (acid IV), *see* 2-naphthylamine-4,8-disulfonic acid
- Caledon jade green, 8
- Cancer of the bladder, 76
- Carbazole, 1
- Carbazole series, orientation, 60
- Carbazole vat dyes, 60
- Carbon tetrachloride, 66
- Carboxylic acids, separation, 31
- o*-Carboxyphenylthioglycolic acid, 330
- Cast iron, 362
- Catalytic oxidation, 171
- Cements, 365
- Centrifuge, 18
- Chicago acid (SS acid), *see* 1-Amino-8-naphthol-2,4-disulfonic acid
- Chicago blue, 148
- Chloramine yellow FF, 335
- Chloranil, 67, 146
- Chloranisidine P, 109
- Chlorate, 67
- Chlorinated rubber, 368

- Chlorination apparatus, 63
 Chlorination hydrochloric acid, 65
 Chlorination reactions
 replacement of substituent groups, 67
 solvents for, 66
 Chlorine
 nascent, 9, 67
 toxicity, 66
 2-Chloro-5-aminobenzoic acid, 169, 295
 4-Chloro-2-aminophenol, 110, 406
 2-Chloro-4-aminophenolbenzyl ether, 406
p-Chloroaniline, diazotization, 244
 4-Chloro-2-anisidine, 109
 1-Chloroanthraquinone, 57, 233
 2-Chloroanthraquinone, 8, 57, 226
 Chlorobenzene, 51, 58, 62
 newer methods of preparation, 65
 nitration, 90
 technical observations, 65
p-Chlorobenzenesulfonic acid, 104
o-Chlorobenzoic acid, 169
p-Chlorobenzotrichloride, 67
 2-Chloro-4-dimethylamino-benzaldehyde, 119, 305
o-Chlorometanilic acid, 107
 Chloronitro-, *see also* Nitrochloro-
 2-Chloro-4-nitroaniline, 66
 4-Chloro-2-nitroanisole, 109
 2-Chloro-5-nitrobenzoic acid, 169
 4-Chloro-2-nitrophenol, 109, 406
 2-Chloro-5-nitrotoluene-4-sulfonic acid, 53
o-Chlorophenol, 10, 67, 145
p-Chlorophenol, 10, 52, 58, 67, 145, 237
 Chlorosulfonic acid, 84, 199
o-Chlorotoluene, 4, 9, 67, 163
p-Chlorotoluene, 52
 2-Chlorotoluene-4-sulfonic acid, 53, 163
 4-Chloro-2-toluidine, 164
 6-Chloro-2-toluidine, 161, 164
 Chrome brown R, 115
 Chromic acid, 8
 Chromium sulfate, 4
 Chromocitronine, 124, 295
 Chromotropic acid, *see* 1,8-Dihydroxynaphthalene-3,6-disulfonic acid
 Chrysazin, *see* 1,8-dihydroxyanthraquinone
 Chrysene, 1
 Chrysophenine G, 149, 283
 Clayton yellow, 336
 Cleaning of reaction vessels, 10
 Cleve acids, *see* 1,6- and 1,7-Naphthylaminesulfonic acids
 Coal tar, 1
 Columbia black, 187
 Commercial dyes, analysis, 399
 Compressed air, 373
 Condensers, 22, 26
 Congo red, 293
 test paper, 395
 Construction materials, 362 ff.
 Copper, 364
 as catalyst, 88, 90
 Costs, 372
 calculation, 378 ff.
 Cotton, 368
 Coupling reactions, general, 249 ff.
p-Cresol, 52
o-Cresotinic acid, 155
 Cuprous chloride, 161
 Cyanosis, 76

D

- Deep black V, 292
 Dehydrothiotoluidine, 332
 Dialkyl sulfates, 8
 Diamine brown M, 286
 Diamine fast red F, 286
 Diamine green B, 288
 Diamine pure blue, 148
 1,4-Diaminoanthraquinone, 232
 1,5-Diaminoanthraquinone, 237
 Diaminodibenzylsulfonic acid, 162, 284
 Diaminodiphenylaminesulfonic acid, 100
 1,7-Diamino-8-naphthol-3,6-disulfonic acid, 405

- sulfonic acid, 204, 208
 Dimethoxydibenzanthrone, 8
 Dimethylamine, 202
 Dimethylaniline, 133
 2,4-Dinitroaniline, 102
 diazotization, 247
 2,4-Dinitroanisole, 98, 116
 1,5-Dinitroanthraquinone, 57, 236
 1,6-Dinitroanthraquinone, 57
 1,7-Dinitroanthraquinone, 57
 1,8-Dinitroanthraquinone, 57
m-Dinitrobenzene, 111
 purification, 112
 toxicity, 112
 2,4-Dinitrobenzenesulfonic acid, 85, 103
 2,4-Dinitrochlorobenzene, 101, 122, 337
 toxicity, 102
 Dinitrochlorobenzenesulfonic acid, 122
 Dinitrodiphenylamine, 102
o,o'-Dinitrodiphenylsulfide, 85
 1,5-Dinitronaphthalene, 55
 1,8-Dinitronaphthalene, 55
 2,4-Dinitro-1-naphthol, 151
 1,2-Dinitro-4-naphthol-7-sulfonic acid, 151
 Dinitrophenol, 102, 337
 Dinitrostilbenedisulfonic acid, 167
 Dioxine N, 201
 Diphenylamine, 140
 technical observations, 142
 Diphenylguanidine, 76
 Diphenylmethane dyes, 298
 Diphenylphthalide, 226
 Direct deep black EW, 291
 Direct fast violet RR, 278
 Disazo dyes, 282
 secondary, 277
 Distillation
 fractional, 24, 64, 341 ff.
 laboratory, 21-27, 34
 with steam, 25
 with superheated steam, 141, 142
 Distilling off solvents, 21
 Dithiosalicylic acid, 330
 Dow Chemical Company, 76, 88
 Drying, 375
 1,2-Diamino-8-naphthol-6-sulfonic acid, 407
 Diaminostilbenedisulfonic acid, 167, 283
 Dianil brown 3GN, 286
 2,5-Dianiline-3,5-dichloroquinone, 147
o-Dianisidine, 93, 99
 diazotization, 261
 Dianthraquinonylamines, 59
 Diazoaminobenzene, 270
 Diazosulfanilic acid, 128
 Diazotization, 241 ff.
 technical procedures, 259
 Dibenzanthrone, 90
 Dibenzopyrenequinone, 60
 1,5-Dibenzoylaminoanthraquinone, 322
 3,8-Dibenzoylpyrene, 223
 2,5-Dichloroaniline, 109
 diazotization, 244
 1,5-Dichloroanthraquinone, 236
 2,6-Dichlorobenzal chloride, 162
 2,6-Dichlorobenzaldehyde, 162
 technical observations, 163
o-Dichlorobenzene, 65, 72
m-Dichlorobenzene, 67
p-Dichlorobenzene, 65, 108
 1,2-Dichlorobenzene-4-sulfonic acid, 53
 2,6-Dichloro-4-nitroaniline, 66
 1,4-Dichloro-5-nitrobenzene, 93, 108
 2,6-Dichlorotoluene, 161
 Diethylaniline, 133
 physical properties, 135, 136
 1,2-Dihydroxyanthraquinone, *see* Alizarin
 1,4-Dihydroxyanthraquinone, *see* Quinizarin
 1,5-Dihydroxyanthraquinone, 236, 319
 1,8-Dihydroxyanthraquinone, 236
 2,3-Dihydroxynaphthalene, 89
 1,8-Dihydroxynaphthalene-3,6-disulfonic acid, 212, 264
 Dihydroxynaphthalenes,
 determination, 388
 2,8-Dihydroxynaphthalene-6-

Drying agents, 22
Drying oven, 373

E

Eczema, 102
Enamel, 367
Epsilon acid, *see* 1-Naphthylamine-3,8-disulfonic acid
Erika red dyes, 335
Eriochrome azurol, 111, 155
Eriochrome black A and T, 202
Eriochrome blue-black R, 202
Eriochrome flavine A, 295
Eriochrome red B, 265
Erioglaucine, 301
Erioviridine B, 301
Ethylbenzylaniline, 134
Ethylbenzylanilinesulfonic acid, 136, 305
Ethyl chloride, 148
Eutectic mixture, 91
Evaporation, 22
Evaporators, triple-stage, 372

F

Factory management, 369 ff.
Fast light yellow G, 129, 265
Fastness to light, determination, 411
Fast red 3GL base, 109
Fast red KB base, 164
Fast red R base, 109
Fast scarlet TR base, 164
Fast yellow, 271
Fehling solution, 118
Ferric chloride, 9
Ferric oxide, 75
Filter centrifuge, 18
Filter materials, 19
Filter presses, 348
Filters
 fluted, 20
 portable, 151
Filtration in the laboratory, 18
Flasks, multiple-necked, 16
Flotation processes, 179
Fluorescence, 47, 48

Fluorination, 67
Formanek absorption tables, 402
Formanilide, 93, 133
Fractional distillation, 24, 64, 341 ff.
Fractional precipitation, 38
Fractionating columns, 24, 342
Fractionating flasks, 23
Freund acid, *see* 1-Naphthylamine-3,6-disulfonic acid
Fuchsin fusion, 69

G

G acid (G⁻salt), *see* 2-Naphthol-6,8-disulfonic acid
Gallamide, 170, 308
Gallamine blue, 171, 309
Gallic acid, 170, 308
Galloycyanine, 310
Gamma acid, *see* 2-Amino-8-naphthol-6-sulfonic acid
Glacial acetic acid, 66, 72
Glass, 366
 apparatus, 16
 filter cloths, 368
 filter funnels, 19
Glucose as reducing agent, 80
Green, dye tables, 399
Griess, Peter, 153
Grinding, 377
Guaiacol, 348

H

H acid, *see* 1-Amino-8-naphthol-3,6-disulfonic acid
Halogenation, general, 65
Halogen atoms
 active, 85, 103
 introduction, 9
Halogen carriers, 66
Hansa yellow, 133, 143, 266
Helianthine, 275
Helio Bordeaux BL, 268
Heliogen blue B, 338
Hemp, 368
Hexanitrophenylamine, 102
Houben, 59

J

J acid (iso-gamma acid), *see*
 Amino-5-naphthol-7-sulfonic acid
Jute, 368

K

Kekulé, 1
Koch acid, *see* 1-Naphthylamine-3,6,8-trisulfonic acid
Kolbe-Schmitt reaction, 154
Kränzlein, Georg, 59

L

Laboratory notebooks, 14
Laboratory reports, 14
Lake colors, 109
Lake red P, 99
Lauth violet, 314
Lead, 365
 hard, 69, 365
 homogeneous, 365
Lead dioxide, *see* Lead peroxide
Lead paper, 396
Lead peroxide, 9
Lead peroxide paste
 evaluation, 397
 preparation, 138
Lead-tin bath metal, 364
Leather, 368
Leuco malachite green, 299
Light fastness
 determination, 411
 standards, 412
Light green SF (yellowish), 301
Liming, 81, 83
Lithol fast yellow R, 133
Lithol red R, 201
Litmus paper, 395
Lunge nitrometer, 69, 72

M

M acid, *see* 1-Amino-5-naphthol-7-sulfonic acid
Magnesium salts, 58

Hydraulic press, 79
Hydrazoanisole, 99
Hydrazobenzene, 124
Hydrazobenzenedisulfonic acid, 123
Hydrocyanocarbodiphenylimide, 325, 326
Hydrogen bromide, 67
2-Hydroxyanthraquinone, 90
Hydroxyl group, introduction, 7
Hydroxynaphthalene, *see* Naphthol
2-Hydroxy-1-naphthoic acid, 54
2-Hydroxy-3-naphthoic acid, 54, 155
3-Hydroxythionaphthene, 331
Hypochlorite, 9, 145, 167

I

Ice colors, 109
Indanthrene blue GCD, BCS, 322
Indanthrene blue RS, 321
Indanthrene brilliant blue, 322
Indanthrene brilliant orange GR, 223
Indanthrene golden yellow GK, 60
Indanthrene red 5 GK, 232, 323
Indanthrene scarlet 2G, 223
Indanthrene yellow GK, 232, 322
Indene, 1
Indian yellow, 275
Indigo, 90
 Heumann synthesis, 323
 Sandmeyer synthesis, 324
Indoxylcarboxylic acid, 324
Intermediates, 2
Iodination, 67
Iron, 362
 nails, 77, 212
 quality for reductions, 75, 77
 shavings, 77
Isatin, 328
 α -Isatinanilide, 325, 327
Iso-gamma acid (J acid), *see*
 2-Amino-5-naphthol-7-sulfonic acid

Malachite green, 300
 Manganese dioxide, 9
 Manganous-manganic oxide, 9, 303
 Martius yellow, 151
 Meldola blue, 9, 310
 Melting point
 apparatus, 43-46
 block, 45
 definitoin, 46
 determination, 41
 Mercuric oxide as sulfonation
 catalyst, 56, 230, 234
 Metachrome brown, 153
 Metal containers, 16
 Metanilic acid, 120
 Methane base, *see* Tetramethyl-
p,p'-diaminodiphenylmethane
 1-Methoxyanthraquinone, 234
 1-Methylaminoanthraquinone, 233
 β -Methylanthraquinone, 223, 227
 Methylene blue, 311
 titration with TiCl₃, 393
 Methylene green, 313
 Michler's hydrol, *see* Tetramethyl-
p,p'-diaminobenzohydrol
 Michler's ketone, *see* Tetramethyl-
p,p'-diaminobenzophenone
 Mikado orange R, 297
 Mirbane, oil of, 160
 Mixed acid, 69
 Mixed melting point, 46
 Mixing, 5
 Modern violet, 310
 Monostral fast blue BS, 338
 Monoethylaniline, 134
 physical properties, 135, 136

N

Naphthamine yellow NN, 335
 Naphthalene, 1, 53
 catalytic oxidation, 171
 Naphthalene-1,5-disulfonic acid,
 219
 Naphthalene-2,7-disulfonic acid,
 209, 308
 Naphthalene-3,6-disulfonic acid,
 209
 Naphthalene green V, 308

Naphthalene- α -sulfonic acid, 214
 nitration, 215
 Naphthalene- β -sulfonic acid, 184
 187
 nitration, 184
 solubility of sodium salt, 189
 Naphthalenesulfonic acids, 53,
 183 ff.
 nitration, 54
 Naphthalene-1,4,5,8-tetracar-
 boxylic acid, 221
 Naphthalene-1,3,5,7-tetrasulfonic
 acid, 55, 211
 Naphthalene-1,3,6-trisulfonic acid,
 211
 Naphthazarin, 122
 Naphthionic acid, 180, 293
 Naphthogene blue RR, 220
 α -Naphthol, 180
 determination, 388
 β -Naphthol, 188
 determination, 365
 sulfonation, 191
 technical observations, 190
 Naphthol AS-ITR, 98
 Naphthol blue black B, 289
 1-Naphthol-3,8-disulfonic acid, 220
 2-Naphthol-3,6-disulfonic acid, 192,
 194, 197
 determination, 390
 2-Naphthol-6,8-disulfonic acid, 192,
 194, 197, 208
 Naphthol pitch, 344
 1-Naphthol-4-sulfonic acid, 182
 determination, 390
 2-Naphthol-1-sulfonic acid, 84, 199
 2-Naphthol-6-sulfonic acid, 192,
 193, 194, 197, 391
 2-Naphthol-3,6,8-trisulfonic acid,
 192
 Naphthol yellow S, 151
 Naphthsultone, 187, 217
 α -Naphthylamine, 176
 diazotization, 245, 260
 technical observations, 178
 β -Naphthylamine, 54, 203
 diazotization, 246
 Naphthylamine black D, 277
 1-Naphthylamine-2,4-disulfonic
 acid, 80, 85, 178

1-Naphthylamine-3,6-disulfonic
 acid, 209, 277
 1-Naphthylamine-3,8-disulfonic
 acid, 219, 220
 1-Naphthylamine-4,8-disulfonic
 acid, 219, 220
 2-Naphthylamine-4,8-disulfonic
 acid, 122, 219, 408
 2-Naphthylamine-5,7-disulfonic
 acid, 205
 determination in presence of
 2,6,8-isomer, 391
 2-Naphthylamine-6,8-disulfonic
 acid, 205
 determination in presence of
 2,5,7-isomer, 391
 1-Naphthylamine-5-sulfonic acid,
 214
 1-Naphthylamine-6-sulfonic acid,
 184
 1-Naphthylamine-7-sulfonic acid,
 184, 280
 1-Naphthylamine-8-sulfonic acid,
 214
 2-Naphthylamine-1-sulfonic acid, 4,
 200
 1-Naphthylamine-3,6,8-trisulfonic
 acid, 211
 2-Naphthylamine-1,5,7-trisulfonic
 acid, 205
 Neoprene, 368
 Nerol dyes, 100
 Nevile-Winther acid, *see*
 1-Naphthol-4-sulfonic acid
 Nickel, 364
 Nitrating acid, 69
 Nitration
 general, 6, 69
 kettle, 69, 71, 101
 of primary aromatic amines, 166
 Nitric acid as oxidizing agent, 9
 Nitrite solution, 1 N, 240, 385
 2-Nitro-4-acetaminotoluene, 52
 3-Nitro-4-acetaminotoluene, 52
p-Nitroacetanilide, 131
 Nitro acid III, *see* 4-Nitro-2-amino-
 phenol-6-sulfonic acid
 4-Nitro-2-aminophenol, 102, 115
 4-Nitro-2-aminophenol-6-sulfonic
 acid, 122
 2-Nitro-4-aminotoluene, 52, 165
o-Nitroaniline, 8, 92
 diazotization, 246
 uses, 93
m-Nitroaniline, 80, 113
p-Nitroaniline, 8, 92, 107, 132
 diazotization, 246, 260
 technical observations, 93
 uses, 93
o-Nitroaniline-*p*-sulfonic acid, 107
p-Nitroaniline-*o*-sulfonic acid, 93,
 99
o-Nitroanisole, 93, 97, 107, 148
p-Nitroanisole, 148
 1-Nitroanthraquinone, 58
 4-Nitroanthraquinonyloxamic acid,
 232
 Nitrobenzene, 66, 68, 72
 chlorination, 117
 technical observations, 69
 toxicity, 76
 Nitrobenzene-2,5-disulfonic acid,
 106
o-Nitrobenzenesulfonic acid, 85, 122
m-Nitrobenzenesulfonic acid, 58,
 120
 technical observations, 122
 Nitrochloro-, *see also* Chloronitro-
 2-Nitro-4-chloroaniline, 109
 diazotization, 247
o-Nitrochlorobenzene, 90, 107, 109
m-Nitrochlorobenzene, 116
p-Nitrochlorobenzene, 90
 Nitrochlorobenzenes
 physical properties, 91
 separation of *o*- and *p*- isomers, 90
 2-Nitrochlorobenzene-4-sulfonic
 acid, 70, 85, 104, 107
 4-Nitrochlorobenzene-2-sulfonic
 acid, 99
 2-Nitro-4-chlorotoluene, 52, 160,
 164
 2-Nitro-6-chlorotoluene, 52, 160,
 164
 Nitro-*p*-dichlorobenzene, 93, 108
 1-Nitro-2,4-dimethoxy-5-chloro-
 benzene, 98
 Nitro filters, 368
 Nitroformanilides, *o*- and *p*-, 133
 Nitro group, lability, 101

Nitrometer, Lunge, 72
 1-Nitro-2-methylantraquinone, 227
 1-Nitronaphthalene, 80, 175
 technical observations, 178
 1-Nitronaphthalene-3,8-disulfonic acid, 219
 1-Nitronaphthalene-4,8-disulfonic acid, 219
 2-Nitronaphthalene-4,8-disulfonic acid, 122, 219
 1-Nitronaphthalene-5-sulfonic acid, 215
 1-Nitronaphthalene-6-sulfonic acid, 184
 1-Nitronaphthalene-7-sulfonic acid, 184
 1-Nitronaphthalene-8-sulfonic acid, 215
 1-Nitronaphthalene-3,6,8-trisulfonic acid, 211
o-Nitrophenol, 147
p-Nitrophenol, 147
 2-Nitrophenol-4,6-disulfonic acid, 153
 Nitrophenols, alkylation, 148
o-Nitrophenol-*p*-sulfonic acid, 107
p-Nitrophenyloxamic acid, 93
o-Nitrophenylhydrazine, 97
p-Nitrophenylhydrazine, 95
 Nitrophenylpyrazolones, 97
 Nitrosobenzene, 78
p-Nitrosodiethylaniline, 309
p-Nitrosodimethylaniline, 308, 311
 reduction, 78, 312
 Nitroso- β -naphthol, 80, 201
p-Nitrosophenol, 85
 Nitrosylsulfuric acid, 9, 247
o-Nitrotoluene, 53, 160
m-Nitrotoluene, 51
 Nitrotoluenes, 3
 3-Nitro-4-toluidine, diazotization, 246
 1-Nitro-2,4,5-trichlorobenzene, 98

O

O acid, *see* *o*-Carboxyphenylthioglycolic acid
 Oleum, 70, 82

Orange II, 262, 378
 Orange IV, 273
 Orientation rules, 50 ff.
 anthraquinone series, 56
 benzene series, 51
 carbazole series, 60
 naphthalene series, 53
 Orienting power, 51
 Orthanic acid, 122
 Oxazine dyes, 308 ff.
 Oxidation methods, 8

P

Package store, 378
 Palatine chrome black 6B, 202
 Para red, 93
 Partial condensers, 24, 341
 Partial reduction, 79, 113
 Patent blues, 301
 Permanent red 2G, 267
 Phenanthrene, 1
 Phenol, 51, 86
 from chlorobenzene, 76, 88
 technical observations, 86
 Phenolphthalein paper, 395
 Phenols, separation, 30
 Phenol-*o*-sulfonic acid, 51
 Phenol-*m*-sulfonic acid, 144, 145
 1-Phenylaminonaphthalene-8-sulfonic acid, 217, 218
 2-Phenylamino-5-naphthol-7-sulfonic acid, 281
 2-Phenylamino-8-naphthol-6-sulfonic acid, 209
 Phenylazodinitrodiphenylamine, 272
 Phenyl diazonium solution, 0.1 N, 395
m-Phenylenediamine, 112, 115
p-Phenylenediamine, 93, 133
m-Phenylenediaminesulfonic acid, 103
p-Phenylenediaminesulfonic acid, 99
 monobenzoyl derivative, 99
 Phenyl-gamma acid, *see* 2-Phenylamino-8-naphthol-6-sulfonic acid

Phenylglycine, 90
 Phenylglycine-*o*-carboxylic acid, 90, 323
 Phenylhydrazine, 80
 Phenylhydrazine-*p*-sulfonic acid, 128
 Phenylhydroxylamine, 78
 rearrangement, 78
 Phenyl-J acid, *see* 2-Phenylamino-5-naphthol-7-sulfonic acid
 1-Phenyl-3-methyl-5-pyrazolone, 129
 Phenyl- α -naphthylamine, 179
 Phosgene, 139
 Phosphorus, 66
 Phosphorus chloride, 66
 Phthalic anhydride, 58, 171, 225, 227
 Phthalimide, 173
 Phthalocyanine dyes, 338
 Picramic acid, 152
 Picric acid, 102, 150
 Pigment colors, 109
 Polar brilliant red 3B
 absorption, 407
 analysis, 404
 Polar yellow 5G, 266
 Polyazo dyes, 95, 277 ff., 282
 Polychlorobenzenes, 62, 65
 Polyphenyl yellow 3G, 297
 Polyvinyl chloride, 368
 Poma-Cesano-Maderno process, 65
 Porcelain, 367
 Precipitates, washing, 20
 Precipitation, fractional, 38
 Presses, 20
 Pressure vessels, general rules on use, 361
 Primuline, 4, 332
 Primuline base, 332
 Primuline fusion, separation of melt, 334
 Primuline red, 334
 Proportions, 13
 Purity
 control, 49
 of starting materials, 11-13
 Purification of products, 34
 Pyramidone, 129
 Pyranthrone, 223

Pyrazolone dyes, 265
 Pyrene, 1, 221
 Pyrenequinone, 222
 Pyrex glass, 16, 366
 Pyridine, 1, 251
 Pyrolusite, 58

Q

Quartz, 367
 Quinizarin, 58, 237, 318
 Quinizarin green, 317
 Quinoline, 1
 synthesis, 69
 Quinoneoxime, 85

R

R acid (R salt), *see* 2-Naphthol-3,6-disulfonic acid
 Raschig rings, 24, 88, 151, 341
 Reaction kettles, 316
 Reaction products, separation, 27
 Reaction tables, 5
 Recipes, 4
 Recrystallization, 35
 Rectification, 23
 Reduction
 apparatus, 94
 electrolytic, 80
 general, 7, 77
 kettles, 77, 94, 96
 partial, 79, 113
 Reductions with sodium sulfide, equations, 114
 Reductive splitting of azo dyes, 402
 Repair shops, 371
 Reprecipitation, 37
 Reservoirs, acid resistant, 366
 Resorcinol, 144
 Rubber, 368
 hard, 368

S

Saccharin, 83
 S acid, *see* 1-Amino-8-naphthol-4-sulfonic acid
 Salicine black U, 202
 Salicylic acid, 154
 technical observations, 155

- Salting out, 39
 Sample dyeing, 375
 Sandmeyer reaction, 9, 67, 161, 163
 Schaeffer acid (and salt), *see* 2-Naphthol-6-sulfonic acid
 Schultz dye tables, 399
 Screw press, 20, 107
 Separation of reaction products, 27
 Silver salt, *see* Anthraquinone-2-sulfonic acid
 Sirius light blue G, 107, 279
 Sodium amide, 90, 324
 Sodium hydrosulfide, 79, 113, 114, 320
 Sodium hydrosulfite, 80, 157, 321, 402, 404
 Sodium hypochlorite, 9, 145, 167
 Sodium β -naphtholate, 54
 Sodium sulfide, 79, 228, 237, 321, 330
 Solvent of crystallization, 42
 Solvents
 distilling off, 21
 for recrystallization, 35
 Spiral gas washing bottle, 62
 Spot test reagents, 396
 SS acid (Chicago acid), *see* 1-Amino-8-naphthol-2,4-disulfonic acid
 Standardization of product, 377
 Standard titrimetric materials, 384
 Stannous chloride, 80, 402, 404, 407
 Starch-iodide paper, 395
 Steam
 consumption, 372
 distillation, 26
 superheater, 26
 trap, 26
 Steel, 364
 Stirrers, 16, 17, 366
 Stirring, 15
 Stone filter funnel, 150
 Stoneware, 365
 Substituents, classification, 50
 Suction filter, 19
 Sulfanilic acid, 126, 262
 diazotization, 248, 261
 pure for analysis, 384
 Sulfides as reducing agents, 76, 79, 113
 Sulfite, removal, 58
 Sulfo chrysoidine, 287
 Sulfo groups, indirect introduction, 85
 ω -Sulfomethyl group, introduction, 85, 250
 Sulfon acid blue R, 218
 Sulfonation
 general, 6, 82
 vessels, 101, 105
 Sulfone reagent, 185, 211, 243
 Sulfones, 85
 Sulfonic acids
 rearrangement, 82
 separation, 31
 1-*p*-Sulfophenyl-3-methyl-5-pyrazolone, 129
 Sulfoxylate, 80
 Sulfur black T, 102, 337
 Sulfur fusions, 332
 Sulfuric acid, heat capacity, 70
 Sulfuryl chloride, 67, 145
 Sun yellow G, 296
 Superheater, 142

T

- Temperature-pressure curves
 for aqueous ammonia, 90
 for aqueous sodium hydroxide, 89
 Test dyeing, 48
 Testing for purity, 40
 Test papers, 395
 Tetrachloroethane, 66
 3,5,8,10-Tetrachloropyrene, 221
 Tetraethyl-*p,p'*-diaminobenzohydrol, 308
 Tetraethyl-*p,p'*-diaminobenzophenone, 140
 Tetramethyl-*p,p'*-diaminobenzohydrol, 138, 307
 Tetramethyl-*p,p'*-diaminobenzophenone, 139, 298, 306
 Tetramethyl-*p,p'*-diaminodiphenylmethane, 137
 Thermometer corrections, 40

- Thermometers, recording type, 88
 Thiazine blue, 314
 Thiazine dyes, 308
 Thiazole paper, 395
 Thiazole yellow, 335, 336
 Thiele melting point apparatus, 44
 Thioamide, 325, 327
 Thiocarbamide, 76, 326
 Thiocyanates in coupling reactions, 250
 Thioflavine T and S, 335
 Thioindigo, 330
 α -Thiosatin, 326, 329
 Thionine blue, 314
 Thioxamidodiphenylamidine, 325, 327
 Thiosalicylic acid, 330
 Thiosulfate in coupling reactions, 250
 Thio-*p*-toluidine, 332
 Tin, 80, 364
 Titanium trichloride solution, 393
 Tobias acid, *see* 2-Naphthylamine-1-sulfonic acid
o-Tolidine, tetrazotization, 261
o-Tolidine-*o*-cresotinic acid intermediate, 285
 Toluene, 1, 51
 Toluenedisulfonic acid, 302
p-Toluenesulfanilides, 53, 250
p-Toluenesulfonethylanilide, 134
o-Toluenesulfonyl chloride, 84
p-Toluenesulfonyl chloride, 67, 84, 134, 304
p-Toluidine, 52
 nitration, 70, 165
 1,2,4-Toluylenediamine, 116
p-Tolyhydroxylaminesulfonic acid, 118
 Trichlorobenzene, 66
 Trinitrophenol, 150
 Triphenylmethane dyes, 298 ff.
 titration with $TiCl_3$, 394
 Trisazo dyes, 279, 281
 Tropaeoline, 273
- U
- Ultraviolet light, 158
- V
- Vacuum, 373
 distillation, 341 ff.
 pumps, 344
 Vanadium oxide, 8
 Vats, 367
 Vesuvine R, 282
 Vicinal derivatives, 53
 Victoria blue B, 140, 306
 Victoria pure blue BO, 140, 307
 Volumetric analysis of dyes,
 Knecht method, 392
 Vulcanization accelerators, 76
- W
- Washing precipitates, 19
 Wave-breaker, 17
 Weighing, 13
 Weiler-Ter Meer process, 75
 Weldon mud, 9, 303
 Wood, 367
 Wool, 368
 Wool blue 5B, 305
 Wool fast blue BL, 220
 Wool green S, 307
 Work bench, 11
 Wrought iron, 364
 scrap, 77, 79, 212
- X
- Xylene, 1
 Xylene blue VS, 301
 Xylene yellow, 266
m-Xylidinesulfonic acid, 84
- Y
- Yields, 10
- Z
- Zambesi black V, 187
 Zinc, 364
 Zinc dust, 80, 123, 125, 402
 evaluation, 396
 Zincke thermometers, 43